











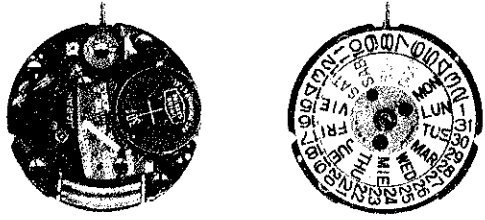































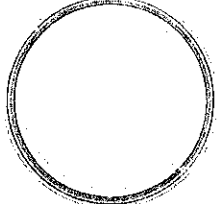



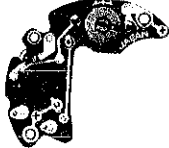





















































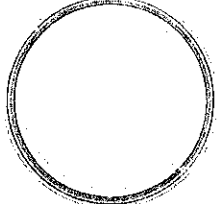



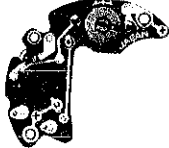





















































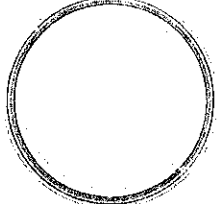



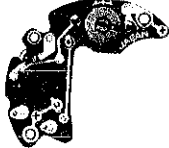













SEIKO

QUARTZ

4004

(Cal. 4633A)

PARTS LIST

Calibre No. 4633A	Jewels 2j	Style Name QUARTZ 4004																																																															
		Characteristics Casing diameter : 26.00 ϕ mm Maximum height : 5.12 mm Frequency of quartz crystal oscillator : 32,768Hz (Hz=Hertz Cycle per second) Driving system : Step motor system (2 poles) Regulation system : Trimmer condenser Second-setting device Calendar (day & date) Instant setting device for day & date calendar Bilingual change-over system for day of week Battery life indicator : Second hand moves in two-second interval.																																																															
<table border="0"> <tr> <td> 122 019</td> <td> 131 062</td> <td> 224 027</td> <td> 225 022</td> <td> 231 025</td> <td> 241 031</td> <td> 261 006</td> <td> 271 022</td> </tr> <tr> <td> 282 014</td> <td> 354 040</td> <td> ☆357 007</td> <td> 383 004</td> <td> 384 012</td> <td> 388 003</td> <td> 391 013</td> <td> ☆397 014</td> </tr> <tr> <td> 486 002</td> <td> 495 001</td> <td> 495 002</td> <td> 556 010</td> <td> 560 002</td> <td> 701 004</td> <td> 706 003</td> <td> 719 002</td> </tr> <tr> <td> 763 001</td> <td> ☆801 041</td> <td> 802 014</td> <td> 808 017</td> <td> 817 010</td> <td> 868 008</td> <td> ☆870 357</td> </tr> <tr> <td> ☆884 050</td> <td> 963 002</td> <td> ☆998 250</td> <td> ☆999 250</td> <td> 4001 044</td> <td> 4002 005</td> <td> 4146 003</td> </tr> <tr> <td> 4216 022</td> <td> 4239 010</td> <td> 4242 038</td> <td> 4242 047</td> <td> 4270 011</td> <td> U.C.C. 301</td> </tr> <tr> <td> 011 541</td> <td> 012 440</td> <td> 012 441</td> <td> 012 713</td> <td> 013 975</td> <td> 017 060</td> <td> 017 061</td> <td> 017 062</td> <td> 017 063</td> <td> 017 064</td> </tr> <tr> <td> 017 065</td> <td> 017 067</td> <td> 017 068</td> <td> 017 069</td> <td> 017 071</td> <td colspan="4" style="text-align: right;">2/1</td> </tr> </table>			 122 019	 131 062	 224 027	 225 022	 231 025	 241 031	 261 006	 271 022	 282 014	 354 040	 ☆357 007	 383 004	 384 012	 388 003	 391 013	 ☆397 014	 486 002	 495 001	 495 002	 556 010	 560 002	 701 004	 706 003	 719 002	 763 001	 ☆801 041	 802 014	 808 017	 817 010	 868 008	 ☆870 357	 ☆884 050	 963 002	 ☆998 250	 ☆999 250	 4001 044	 4002 005	 4146 003	 4216 022	 4239 010	 4242 038	 4242 047	 4270 011	 U.C.C. 301	 011 541	 012 440	 012 441	 012 713	 013 975	 017 060	 017 061	 017 062	 017 063	 017 064	 017 065	 017 067	 017 068	 017 069	 017 071	2/1			
 122 019	 131 062	 224 027	 225 022	 231 025	 241 031	 261 006	 271 022																																																										
 282 014	 354 040	 ☆357 007	 383 004	 384 012	 388 003	 391 013	 ☆397 014																																																										
 486 002	 495 001	 495 002	 556 010	 560 002	 701 004	 706 003	 719 002																																																										
 763 001	 ☆801 041	 802 014	 808 017	 817 010	 868 008	 ☆870 357																																																											
 ☆884 050	 963 002	 ☆998 250	 ☆999 250	 4001 044	 4002 005	 4146 003																																																											
 4216 022	 4239 010	 4242 038	 4242 047	 4270 011	 U.C.C. 301																																																												
 011 541	 012 440	 012 441	 012 713	 013 975	 017 060	 017 061	 017 062	 017 063	 017 064																																																								
 017 065	 017 067	 017 068	 017 069	 017 071	2/1																																																												

☆⇒ Please see remarks on the next reverse page.

Calibre No.		Jewels	Style Name	
4633A		2j	QUARTZ 4004	
PART NO.	PART NAME	PART NO.	PART NAME	
122 019	Center wheel bridge	017 064	Tube for circuit block screw A	
131 062	Third wheel bridge	017 065	Tube for circuit block screw B	
224 027	Center wheel	017 067	Tube for setting lever spring screw	
225 022	Cannon pinion	017 068	Tube for date dial guard screw A	
231 025	Third wheel & pinion	017 069	Tube for date dial guard screw B	
241 031	Fourth wheel & pinion	017 071	Date driving wheel pin	
261 006	Minute wheel	U.C.C. 301	Silver oxide battery	
271 022	Hour wheel			
282 014	Clutch wheel			
354 040	Winding stem			
☆357 007	Winding stem			
383 004	Setting lever			
384 012	Yoke			
388 003	Setting lever spring			
391 013	Second-setting lever			
☆397 014	Lever for unlocking stem			
486 002	Clutch wheel guard			
495 001	Spacer A for third wheel bridge			
495 002	Spacer B for third wheel bridge			
556 010	Date finger			
560 002	Friction spring for fourth wheel & pinion			
701 004	Fifth wheel			
706 003	Sixth wheel & pinion			
719 002	Day corrector			
763 001	Second setting transmission lever			
☆801 041	Date dial			
☆801 050	Date dial			
802 014	Date driving wheel			
808 017	Date dial guard			
817 010	Intermediate date wheel			
868 008	Day finger			
☆870 357	Day star with dial disk			
☆884 050	Holding ring for dial			
963 002	Snap for day star with dial disk			
☆998 250	Indicator wheel			
☆999 250	Indicator wheel spring			
4001 044	Circuit block			
4002 005	Coil block			
4146 003	Step rotor			
4216 022	Insulator for battery			
4239 010	Rotor stator			
4242 038	Plus terminal A of battery connection			
4242 047	Plus terminal B of battery connection			
4270 011	Battery connection			
011 541	Lower hole jewel for step rotor			
011 541	Upper hole jewel for step rotor			
012 440	Coil block screw (Screw for plus terminal A of battery connection)			
012 440	Circuit block screw			
012 441	Center wheel bridge screw			
012 441	Third wheel bridge screw (Screw for plus terminal B of battery connection)			
012 441	Date driving wheel screw			
012 441	Date dial guard screw A			
012 713	Date dial guard screw B			
012 713	Yoke spring holder screw			
013 975	Eccentric dial pin			
017 060	Tube for center wheel bridge screw			
017 061	Tube for third wheel bridge screw A			
017 062	Tube for third wheel bridge screw B			
017 063	Tube for coil block screw			

☆⇨ Please see remarks on the reverse page.

Part numbers in light letters are not shown in photos.

Calibre No.

4633A

Jewels

2j

Style Name

QUARTZ 4004

Remarks :

Winding stem (☆357 007)

Indicator wheel (☆998 250)

Indicator wheel spring (☆999 250)

} Used only for the models with rotating dial ring.

Lever for unlocking stem

☆397 014.....Used for the one-piece or square type water-resistant case.

Adjust the length of the unlocking stem lever by cutting the tail on the position marked arrow, which should be exposed on the case face, as shown in the illustration.

Movement in the case dial upside

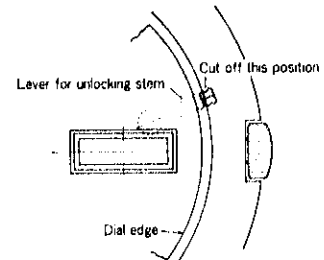

Date dial

☆801 041 (Black figures on white background).....Used when both the crown and the calendar frame are located at **3** o'clock position.

☆801 050 (White figures on black background).....Used when both the crown and the calendar frame are located at **3** o'clock position.

If any other type of date dial is required, specify ① Cal No. ② jewels ③ the crown position ④ the calendar frame position and ⑤ Dial No.

Day star with dial disk

☆870 357 (English ↔ Spanish, black figures on white background).....Used when both the crown and the calendar frame are located at **3** o'clock position.

If any other type of day star with dial disk is required, specify the number printed on the disk.

Holding ring for dial

The type of a holding ring for dial is determined based on the design of cases and dials.

Check the case number and refer to "SEIKO Quartz Casing Parts List" to choose an appropriate holding ring for dial.

TECHNICAL GUIDE

CONTENTS

SEIKO
QUARTZ

CAL.4633A

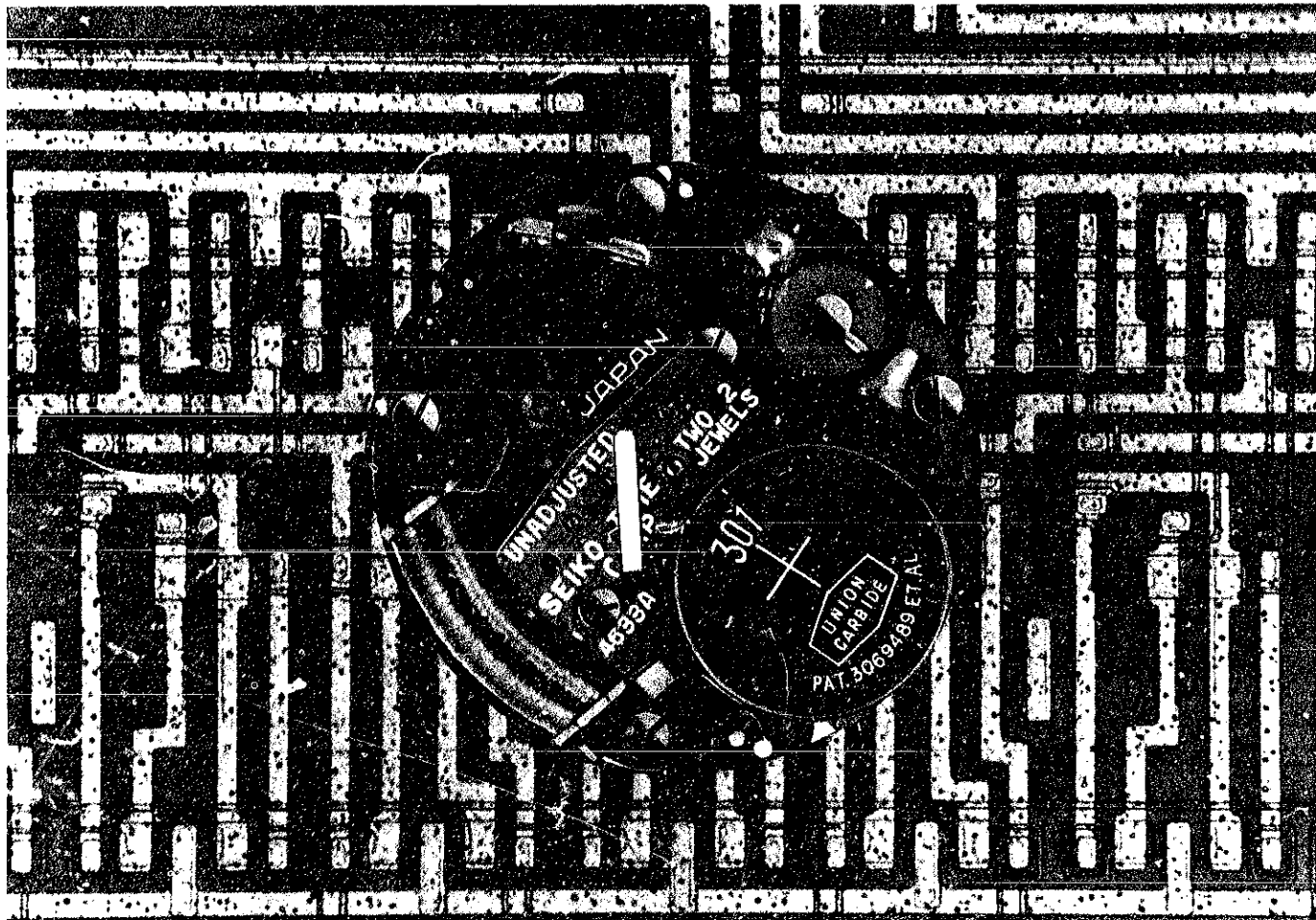

1. Specifications	2
2. Outline of functioning	3
3. Calendar mechanism	3
4. Case	4
5. Battery life indicator	4
6. After-sale servicing instruments and materials	5
7. Disassembling, reassembling, lubricating and cleaning	5
1) Calendar mechanism	6
2) Electronic circuit, gear train and setting mechanism	8
3) Cleaning	10
8. Checking and adjustment	11
Guide for checking and adjustment	11
A: Check output signal	12
B: Check battery voltage	12
C: Check battery conductivity	12
D: Check circuit block conductivity	14
E: Check reset condition	14
F: Check coil block	16
G: Check output signal	16
H: Check second setting lever	16
I: Check accuracy	16
• Time accuracy adjusting method	18
• Measuring current consumption	18

SEIKO QUARTZ Calibre 4633A

Calibre 4633A

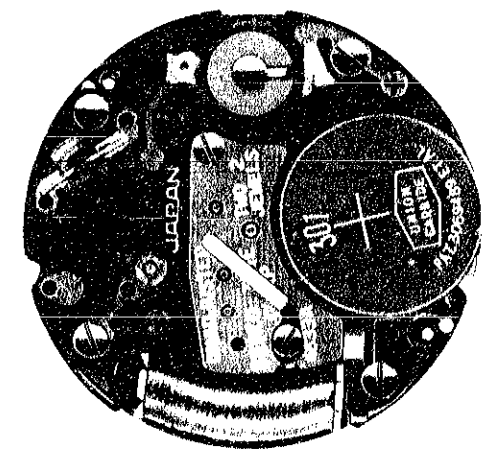
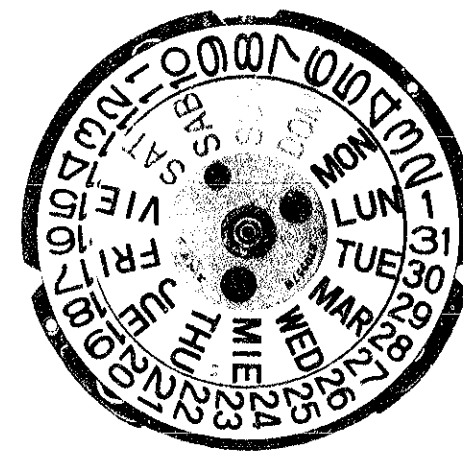

Movement

1. Specifications

Item	Calibre	Cal. 4633A
Time indication		Hour, minute & second hands
Additional mechanism		Calendar (day & date) Bilingual change-over system for the day of the week Instant day and date setting Second setting device (every second setting) Battery life indicator Electronic circuit reset switch
Crystal oscillator		32,768 Hz (Hz = Hertz . . . cycles per second)
Loss/gain		Loss/gain at normal temperature Monthly rate: less than 15 seconds (Annual rate: less than 3 minutes)
Casing diameter		φ 26.0 mm
Height		5.1 mm
Operational temperature range		-10°C ~ +60°C (14°F ~ 140°F)
Driving system		Step motor system (2 poles)
Regulation system		Trimmer condenser
Battery power		Silver Oxide Battery (U.C.C. 301) Battery life is over one year. Voltage 1.5V
Jewel		2 jewels

2. Outline of functioning

- (1) The crystal oscillator by supplying voltage oscillates accurately at 32,768 Hz.
- (2) The electronic circuit receives the 32,768 Hz oscillations (electric signals) and converts them into impulses at the rate of one per second, i.e. 1/2 (16,384 Hz), 1/2 (8,192 Hz) . . .
- (3) The one-per-second signals are transmitted to the coil block, causing the step motor to rotate once every second in 180° increments.
- (4) This rotation is transmitted to the gear train thus moving the hands.

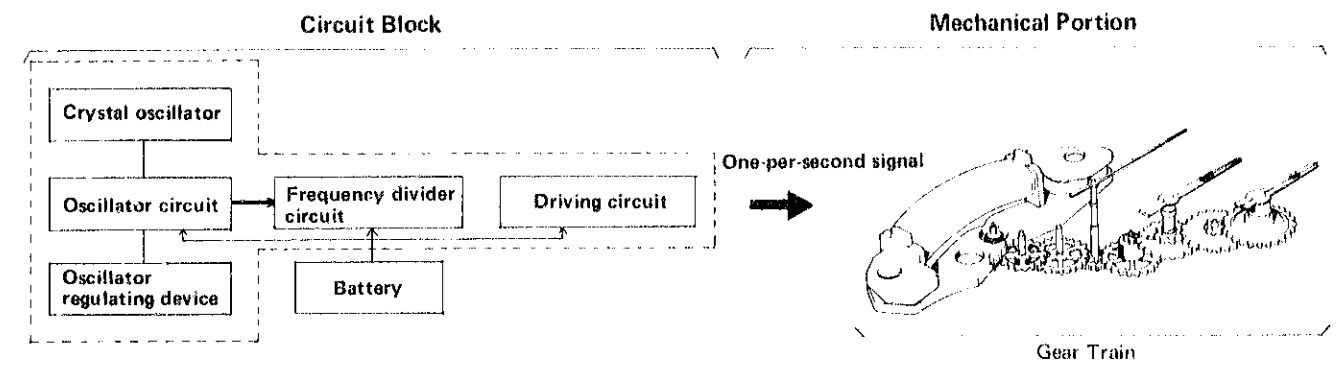
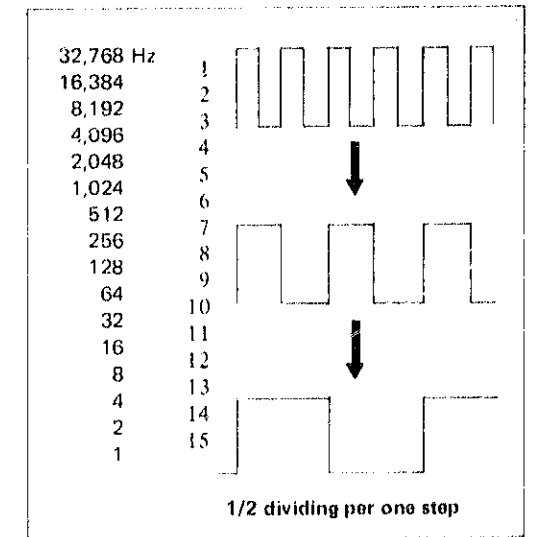

3. Calendar mechanism

Calendar and hand setting

- Normal position: Free
- First click: Date change . . . counterclockwise
Day change . . . clockwise
- Second click: Hand setting, second setting & reset switch

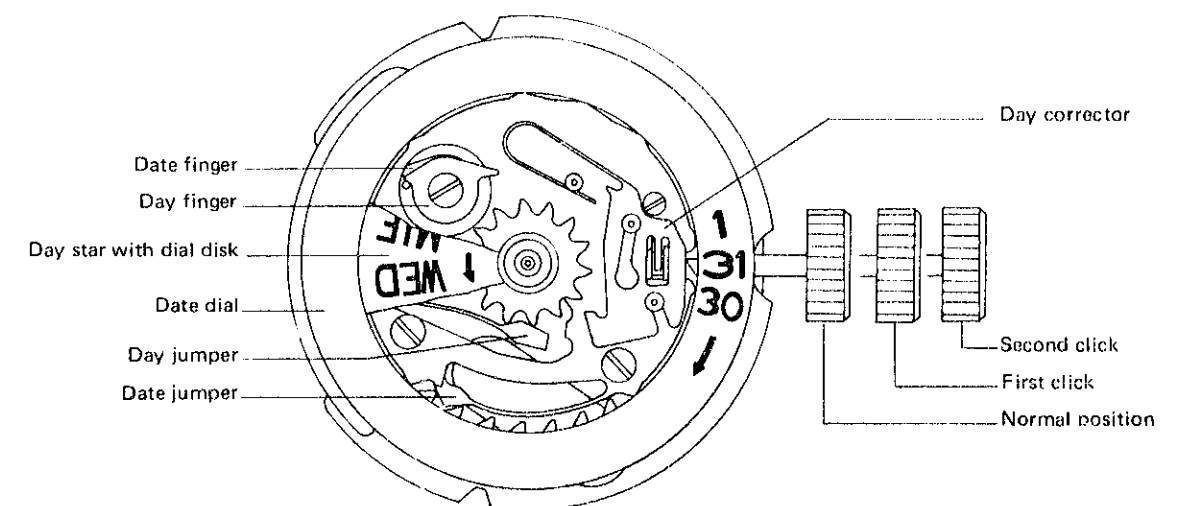

4. Case

- **Current flow**

The current flows from the battery through a case to the movement.

- **How to close the snap type case back**

- (1) Bring the line of both alignment notch on the case back and caseband.
- (2) Select a suitable inserting disk which fits the case back. Use an inserting disk with a diameter of from 31.0 to 32.0 mm. If an inserting disk with a smaller diameter is used, the case back cannot be snapped closed sometimes.

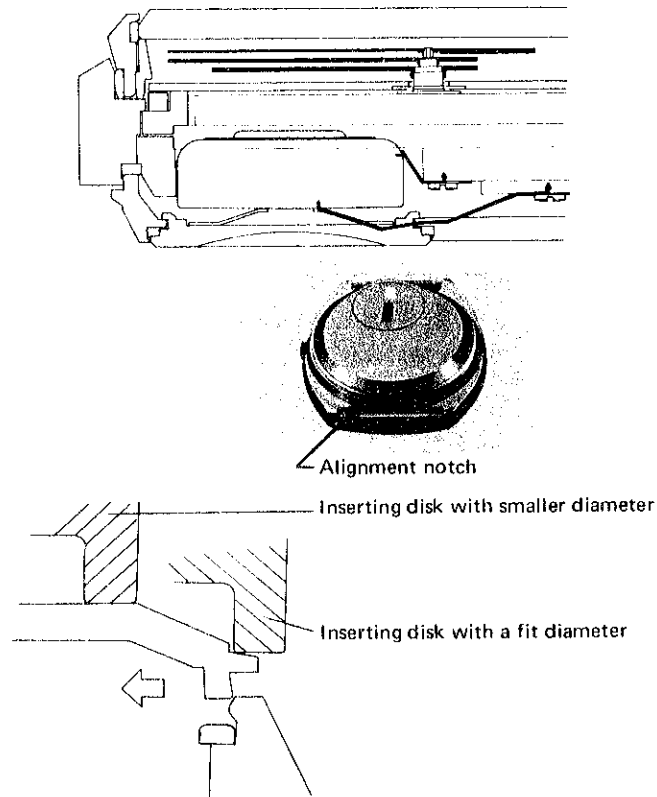

5. Battery life indicator

The silver oxide battery used in the watch maintains constant voltage.

But when its life comes to its end, the voltage will drop sharply. (See Fig. 1)

As soon as the battery voltage drops down, the battery life indicator lets the second hand leap every two seconds. This indicates that the battery should be replaced.

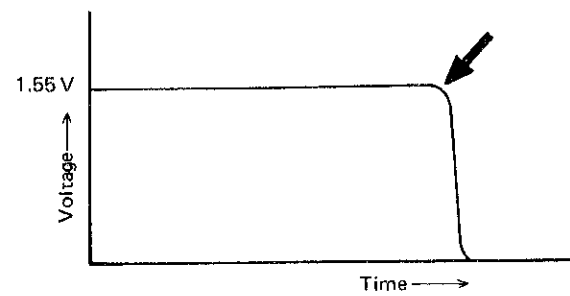

Fig. 1

When the battery voltage is normal

The second hand leaps every second graduation. The electrical signal from the circuit which drives the step rotor assumes the pattern as shown in Fig. 2.

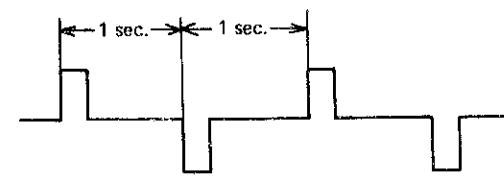

Fig. 2

When the battery voltage is dropped

The second hand leaps every two second graduation, indicating that the battery life is coming to its end. In this case, the electrical signal from the circuit will be as shown in Fig. 3. However the second hand leaps every two second, the watch will remain accurate during one week period.

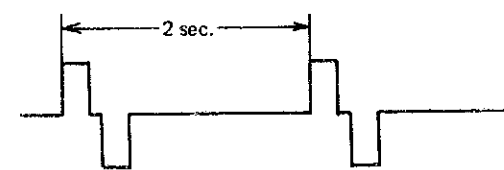
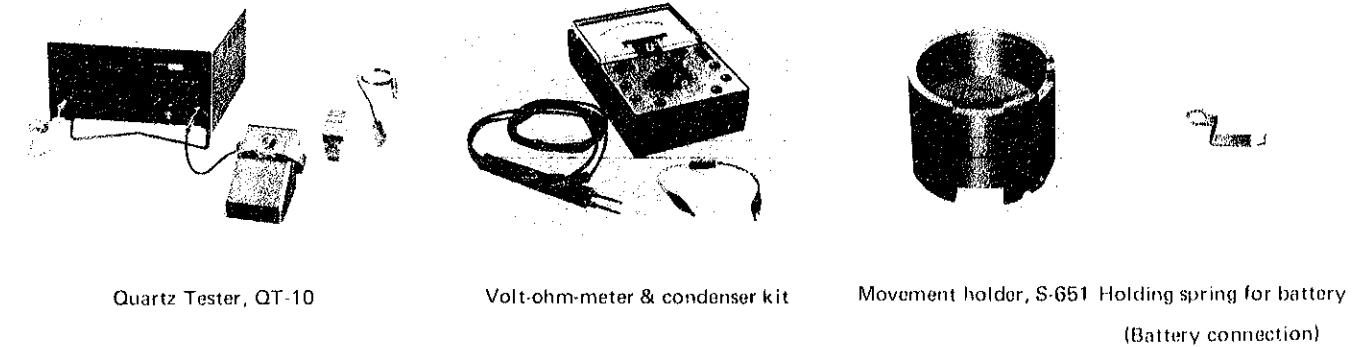

Fig. 3

6. After-sale servicing instruments and materials

For after-sale servicing of the SEIKO Quartz watch, Cal. 4633A, the following after-sale servicing instruments and materials are necessary.



7. Disassembling, reassembling, lubricating and cleaning

- **Disassembling and reassembling**

Disassembling procedures Figs.: ①~④⑨

Reassembling procedures Figs.: ④⑨~①

- **Lubricating**

Type of oil

- Moebius A
- SEIKO Watch Oil, S-6

Oil quantity

- ∞ Liberal quantity
- Normal quantity
- ◊ Extremely small quantity

1) Calendar mechanism

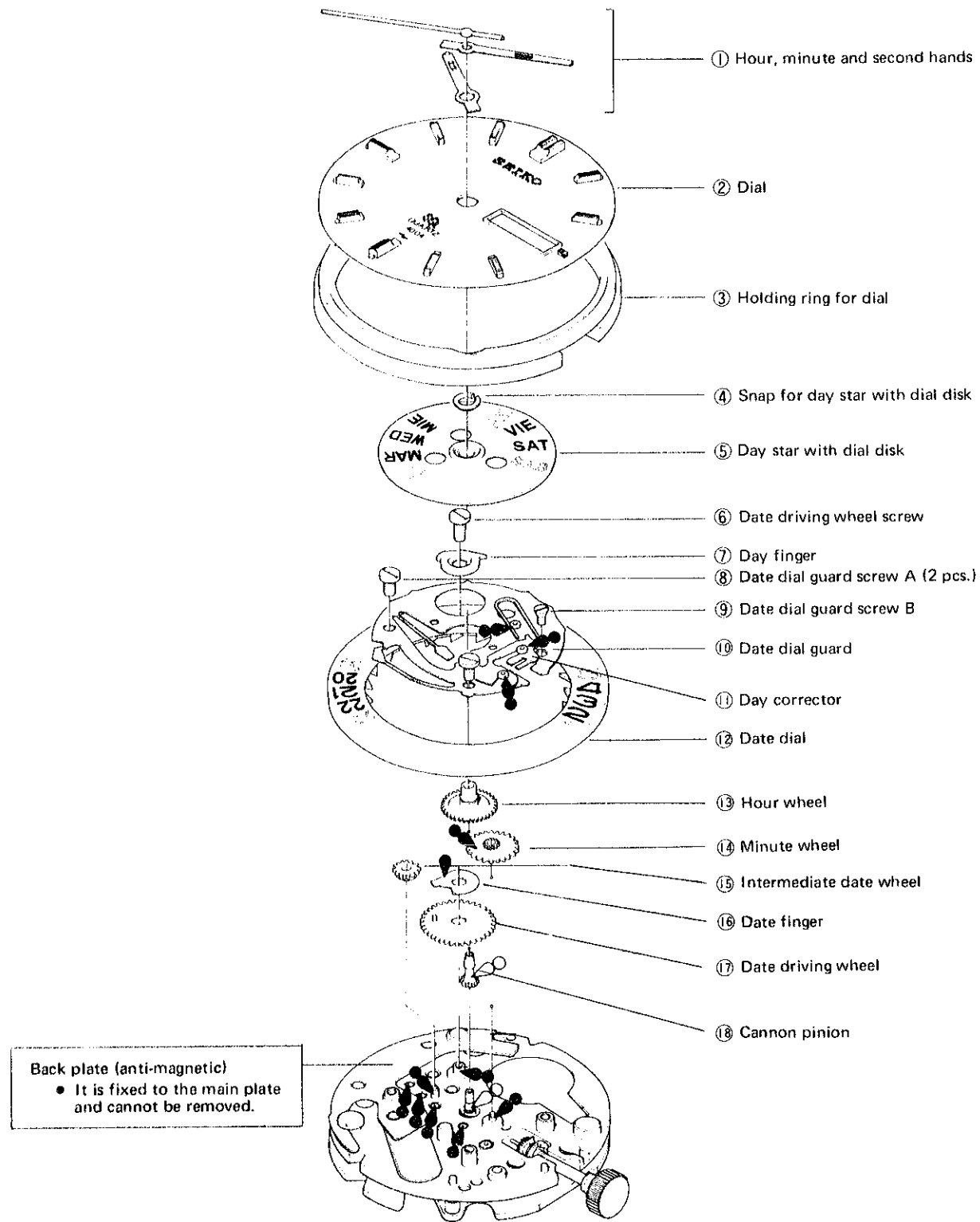

Remarks for disassembling and reassembling

• How to remove and mount the hour, minute and second hands ①

Remove and mount the hands after pulling the crown out to the second click.

Put the second hand so that it brings the line of the second graduation position exactly. (either even numbered or odd numbered second graduation)

• How to remove and replace the dial ②

After turning the eccentric dial pin between 90° and 150° to the arrow marked direction, removing and replacing the dial is possible.

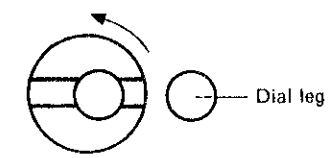

Untighten

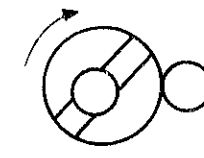

Tighten

• Date dial guard ⑩

Be sure to check that the tail of the date jumper portion of date dial guard gears with the date dial under the date dial guard.

When tightening the date dial guard screw, tighten the date dial guard screw B first.

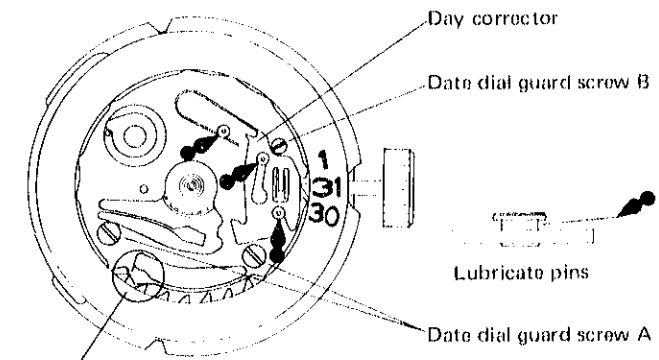

Set the tail of the date jumper portion under the date dial guard.

• How to fix the day finger and date finger ⑦ & ⑩

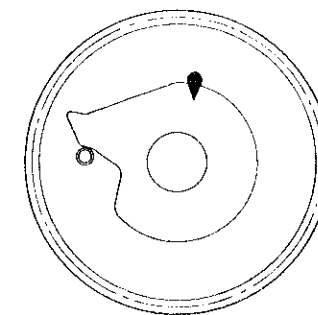

Place the date finger.

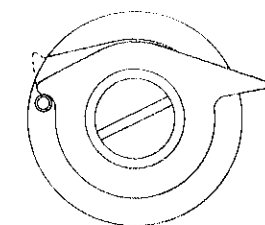

After placing the date dial guard, place the day finger.

2) Electronic circuit, gear train and setting mechanism

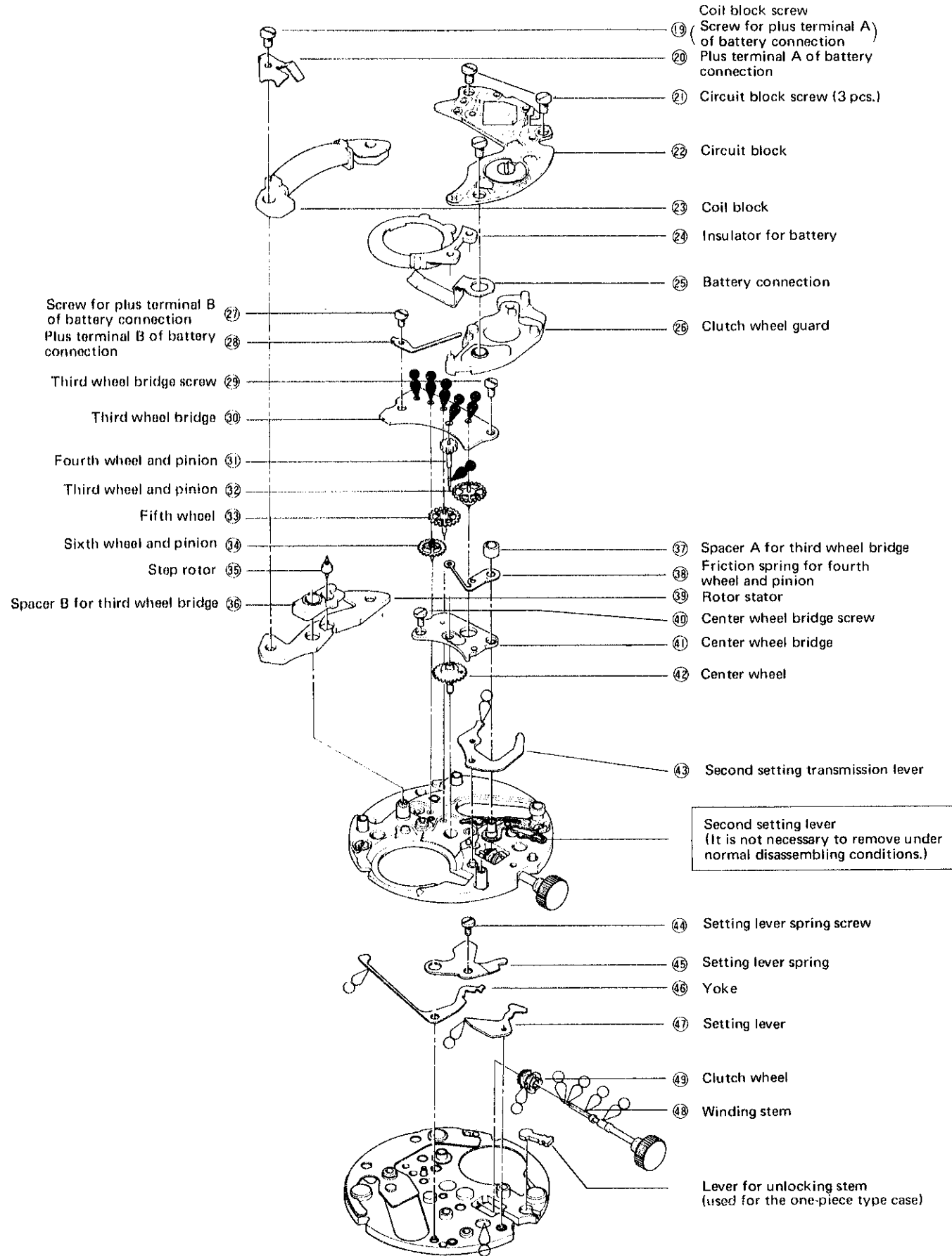

Remarks for disassembling and reassembling

• Reassembling of the second setting transmission lever (43)

Pull out the crown to the second click, and reassemble the second setting transmission lever. After reassembling the center wheel bridge, push the crown in to the normal position.

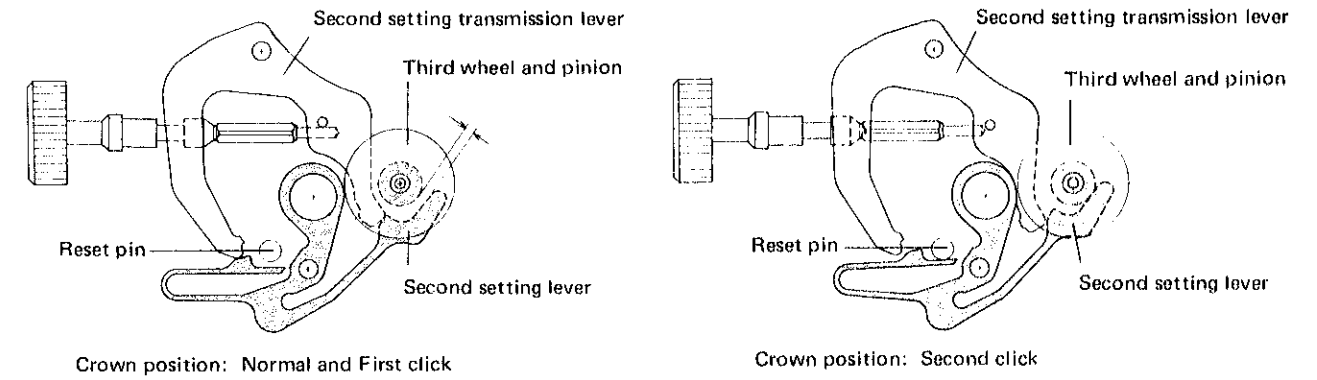

After reassembling the second setting transmission lever, check the following.

- Check to see that the second setting lever can regulate the third wheel and pinion when the crown is at the second click. Remove the circuit block and check to see the condition between the third wheel and pinion and the second setting lever at the following crown positions.

Crown at normal position & first click:

There must be clearance between the third wheel and pinion and the second setting lever. (Upper left figure)

Crown at second click:

The second setting lever touches the third wheel and pinion. (Upper right figure)

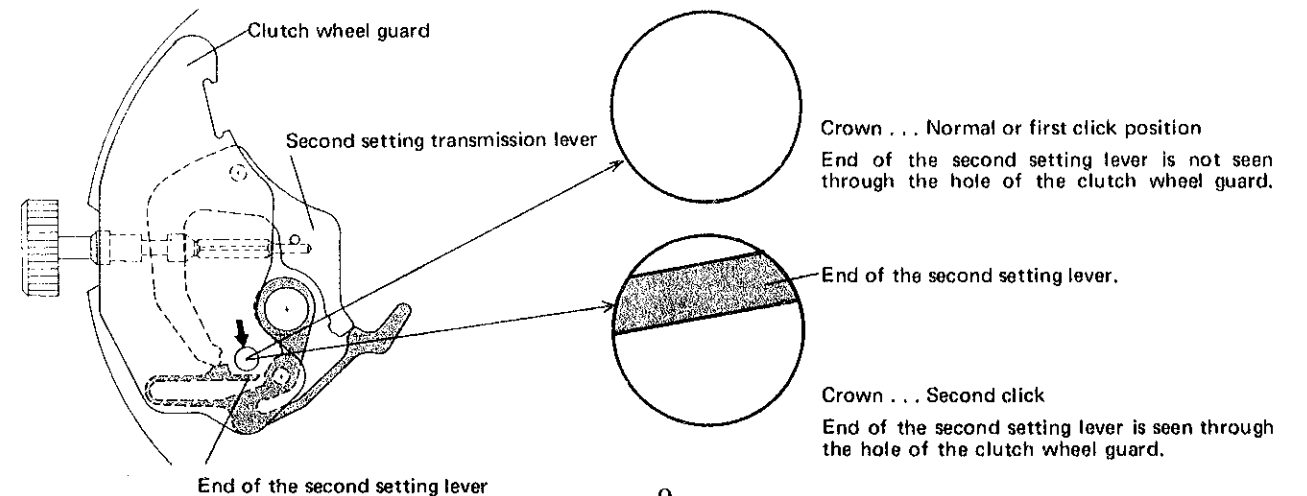

- Check the position of the end of the second setting lever by looking through the hole (arrow marked portion in the figure below) of the clutch wheel guard. As the reset pin is set in this hole, if the end of the second setting lever is seen through the hole, it is considered that the end of the second setting lever will touch the reset pin.



3) Cleaning

Since several special parts (electronic parts, etc.) are used in the SEIKO Quartz Cal. 4633A, use the following cleaning methods when cleaning.

HOW TO CLEAN

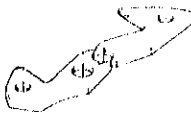
Name of parts	Cleaning	Drying	Solution	Remarks
Circuit block  Coil block 	DO NOT CLEAN			<ul style="list-style-type: none"> • Conducting portion <u>ONLY</u> may be cleaned with a cloth moistened with benzine or alcohol. Dry in <u>COOL</u> air.
Step rotor  Rotor stator 	Rinse or gently scrub with a brush.	Cool air drying	Benzine	<ul style="list-style-type: none"> • Since the step rotor is magnet, use a clean solution. Any foreign matter which cannot be removed by cleaning should be removed with adhesive tape or Rodico. • Be careful not to bend the rotor stator.
Plastic parts	Rinse or gently scrub with a brush.	Cool air drying	Alcohol	
Parts other than the above	Clean with cleaner, rinse or gently scrub with a brush.	Cool or hot air drying	Benzine or trichloroethylene	

8. Checking and adjustment

Guide for Checking and Adjustment

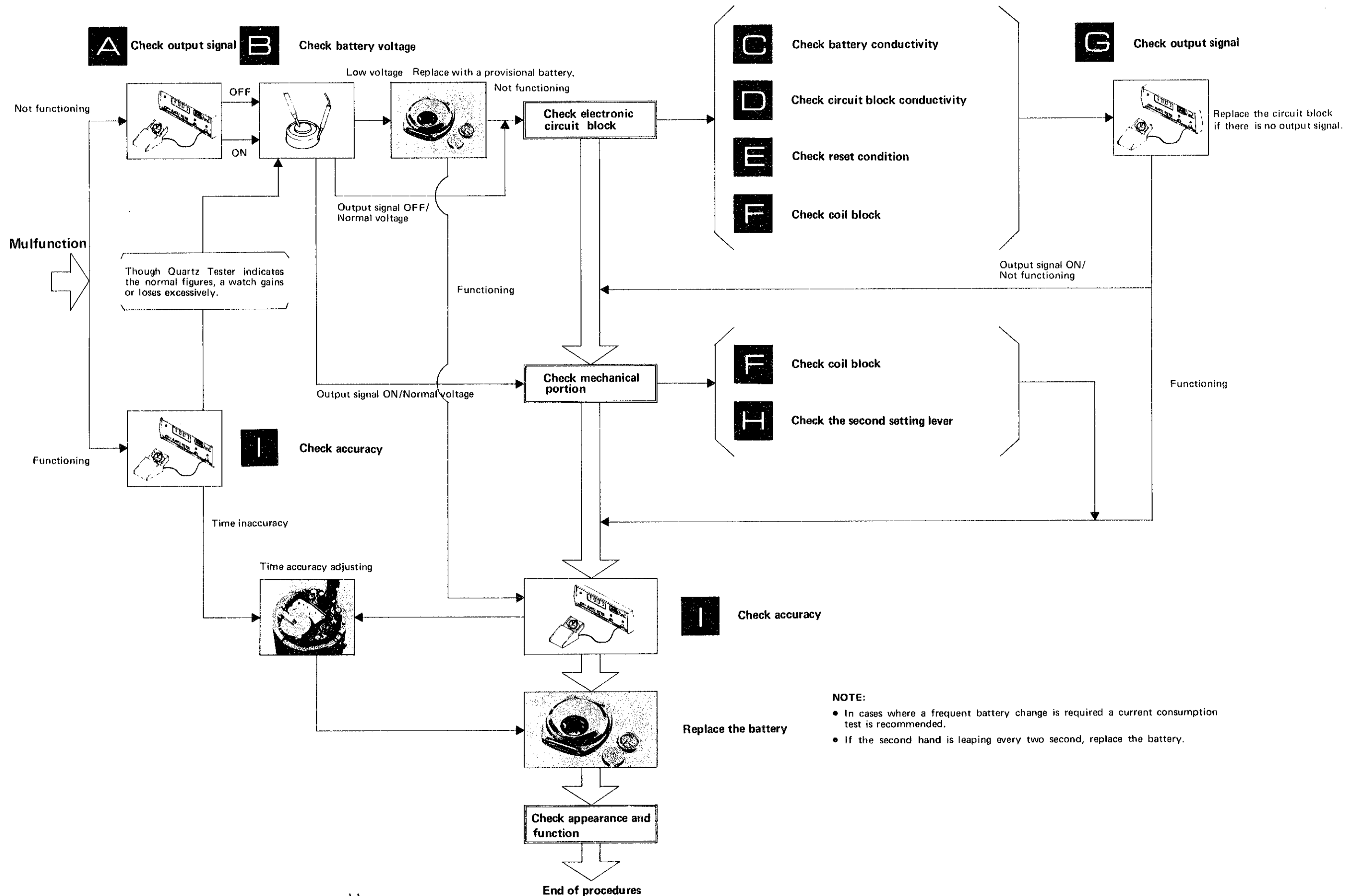

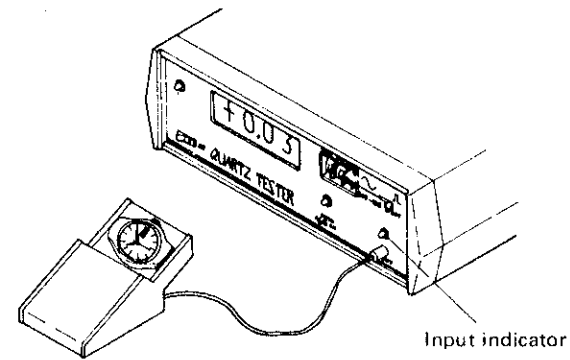
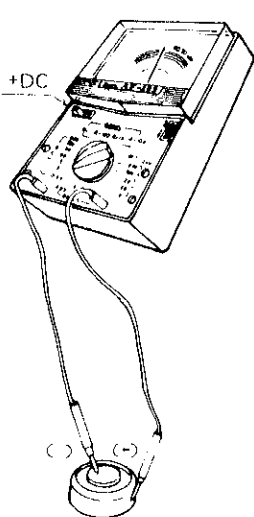
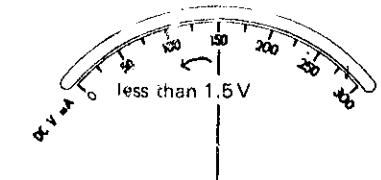
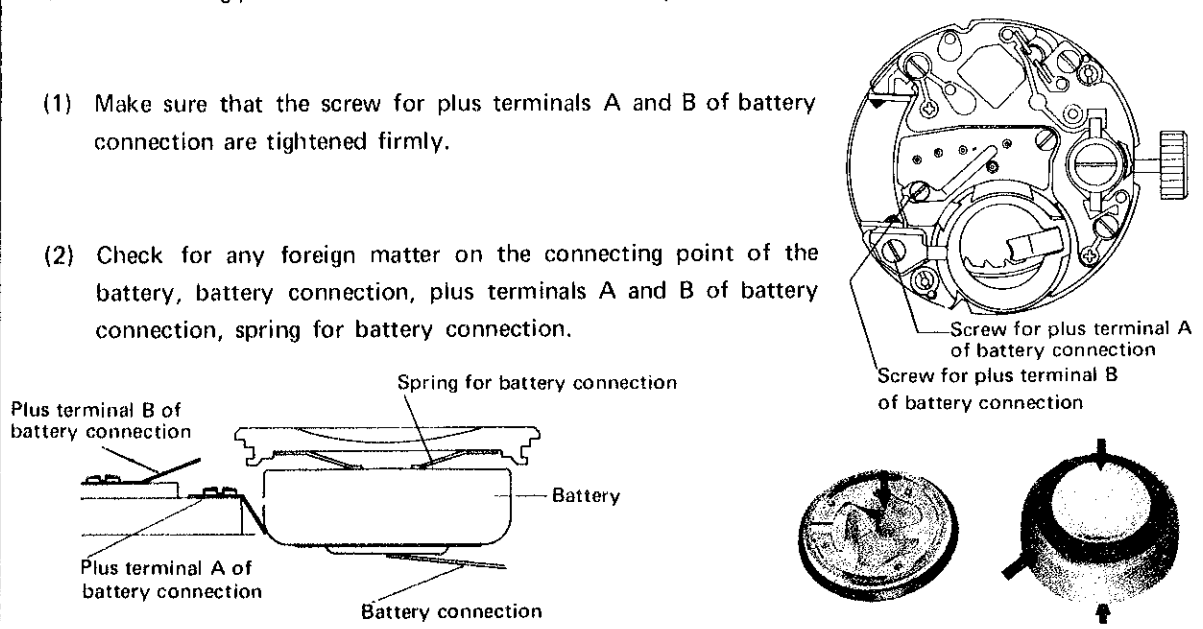
	Procedures		Results	Adjustment and Repair
A CHECK OUTPUT SIGNAL	<p>Check for output signal</p> <p>(1) Set up the Quartz Tester.</p> <p>(2) Checking Check for output signal (Blinking input indication light)</p> 		<p>One-second blinking →</p> <p>No one-second blinking →</p>	<p>Proceed to B</p>
B CHECK BATTERY VOLTAGE	<p>Use the following procedures to check battery voltage</p> <p>(1) Set up the Volt-ohm-meter. Range to be used DC 3V</p> <p>(2) Measuring</p> <ul style="list-style-type: none"> Probe Red (+) Battery surface (+) Probe Black (-) Battery surface (-) <p>(Note) When handling the battery, use non metallic tweezers or finger cots.</p> 		<p>More than 1.5V →</p> <p>Less than 1.5V →</p> 	<p>In procedure A if one-second blinking is found, check the Mechanical Portion.</p> <p>In procedure A if one-second blinking is NOT found, check the Electronic Circuit Block.</p> <p>Replace with a provisional battery.</p> <ul style="list-style-type: none"> If a watch operates after battery replacement, proceed to I If a watch does not operate, check the Electronic Circuit Block.
C CHECK BATTERY CONDUCTIVITY	<p>Use the following procedures to check to see if the battery current flow to the circuit is normal.</p> <p>(1) Make sure that the screw for plus terminals A and B of battery connection are tightened firmly.</p> <p>(2) Check for any foreign matter on the connecting point of the battery, battery connection, plus terminals A and B of battery connection, spring for battery connection.</p> 		<p>No loosened screw →</p> <p>Loosened screw →</p> <p>Uncontaminated →</p> <p>Contaminated →</p>	<p>Proceed to C₂</p> <p>Retighten screw .</p> <p>Proceed to D</p> <p>Wipe off carefully .</p>

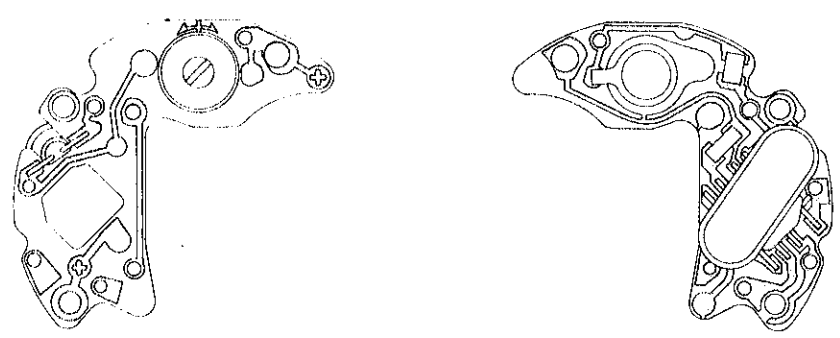
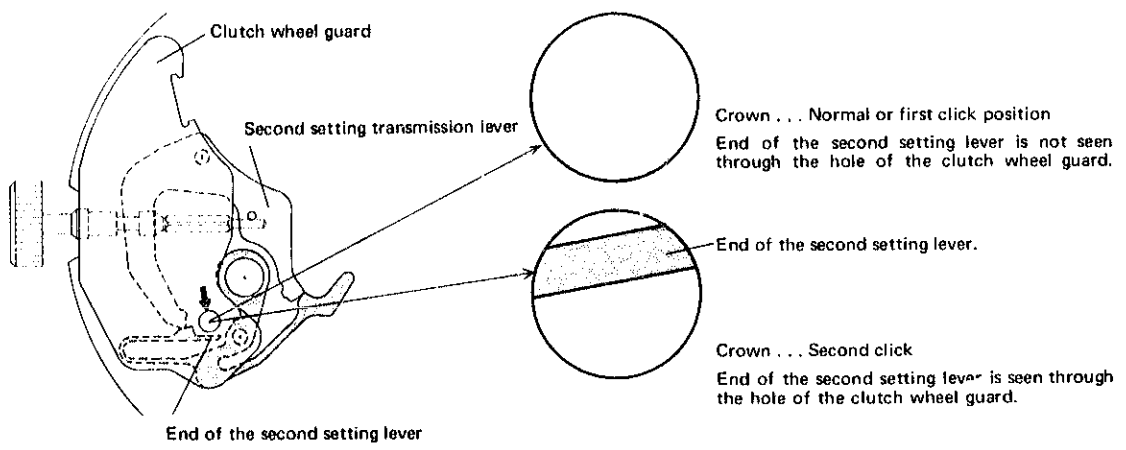
	Procedures		Results	Adjustment and Repair
D CHECK CIRCUIT BLOCK CONDUCTIVITY	<p>Check for short circuit and defective contact of the circuit block conducting portion.</p> <p>(1) Check for looseness the three (3) screws of the circuit block.</p> <p>(2) Check for short circuit, disconnection of the soldered portion, lead pattern and foreign matter on the connecting surface of the circuit block.</p> 		<p>No loosened screw →</p> <p>Loosened screw →</p> <p>No disconnection of soldered portion, short circuit or foreign matter. →</p> <p>Disconnection of the soldered portion, short circuit and foreign matter. →</p>	<p>Proceed to D₂</p> <p>Retighten screw.</p> <p>Proceed to E</p> <ul style="list-style-type: none"> • Replace the circuit block when there is disconnection of the soldered portion or short circuit. • If contaminated, wipe off foreign matter on the connected place.
M CHECK RESET CONDITION	<p>(1) Check the reset condition using the following procedures.</p> <ul style="list-style-type: none"> • Check to see if the output signal is off or the second hand stops exactly when the crown is pulled out to the second click. • Check to see if the output signal is on or the second hand starts moving exactly after one second when the crown is pushed in to the normal position from the second click. <p>(2) Remove the circuit block and check the position of the end of the second setting lever through the hole of the clutch wheel guard (arrow marked portion).</p> <p>As the reset pin is set in this hole, if the end of the second setting lever is seen through the hole, it is considered that the end of the second setting lever will touch the reset pin.</p> 		<p>Stops immediately and starts moving again after one second. →</p> <p>Does not stop or moves irregularly. →</p> <p>The second setting lever is not seen when the crown is at the normal position and pulled out to first click. The second setting lever is seen when the crown is pulled out to the second click. →</p> <p>The second setting lever is seen when the crown is at the normal position and pulled out to the first click. The second setting lever is not seen when the crown is pulled out to the second click. →</p>	<p>Proceed to F</p> <p>Proceed to E₂</p> <p>Proceed to F</p> <p>Replace the second setting lever.</p>

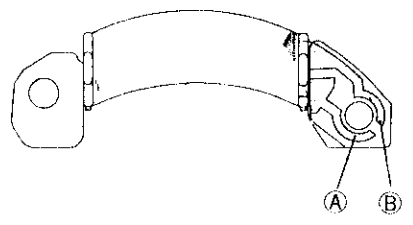
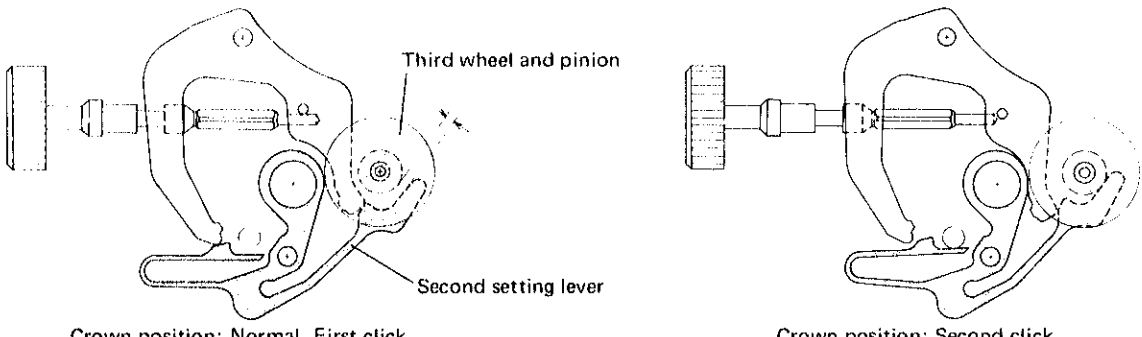
	Procedures
CHECK COIL BLOCK	<p>Remove the circuit block and check for broken coil wire and short circuit.</p> <p>(1) Set up the Volt-ohm-meter. Range to be used OHMS R × 100</p> <p>(2) Checking Touch the red and black probes to the two terminals (A, B) of the coil respectively.</p> 
CHECK OUTPUT SIGNAL	<p>Check for output signal.</p> <p>(1) Set up the Quartz Tester.</p> <p>(2) Checking Check for output signal (blinking input indication light).</p>
CHECK SECOND SETTING LEVER	<p>Check to see if the second setting lever regulates the third wheel and pinion.</p> <p>Remove the circuit block and check the condition between the third wheel and pinion and the second setting lever as follows.</p> <p>Check to see if there is clearance between the third wheel and pinion and the second setting lever when the crown is at the normal position and pulled out to the first click (lower left figure).</p> <p>Check to see if the second setting lever touches the third wheel and pinion when the crown is pulled out to the second click (lower right figure).</p> 
CHECK ACCURACY	<p>Check gain and loss of time.</p> <ul style="list-style-type: none"> Set up the Quartz Tester.

Results	Adjustment and Repair
<p>1.5 KΩ ~ 3.5 KΩ</p> <p>Less than 1.5 KΩ (Short circuit)</p> <p>More than 3.5 KΩ (Broken wire)</p>	<ul style="list-style-type: none"> If Checking the Electronic Circuit Block, proceed to G If Checking the Mechanical Portion proceed to H <p>Replace the coil block.</p>
<p>One-second blinking</p> <p>Not functioning</p> <p>Functioning</p> <p>No one-second blinking</p>	<p>Check the Mechanical Portion,</p> <p>Proceed to I</p> <p>Replace the circuit block.</p>
<p>Clearance, the crown at the normal position and first click</p> <p>No clearance, the crown at the second click</p> <p>No clearance, the crown at the normal position and the first click.</p> <p>Clearance, the crown at the second click.</p>	<p>Proceed to I</p> <p>Replace the second setting lever.</p>
<p>Normal</p> <p>Defective</p>	<p>Replace the battery.</p> <p>Adjust time accuracy.</p>

Time accuracy is adjusted by turning the trimmer condenser.

- Adjustment should be made after ascertaining by the Quartz Tester whether the watch tends to gain or lose.

The watch gains or loses according to the direction in which the trimmer condenser is turned.

- Note for handling of Trimmer condenser
 - (1) Avoid excessive depressing.
 - (2) Avoid turning the Trimmer condenser unnecessarily.

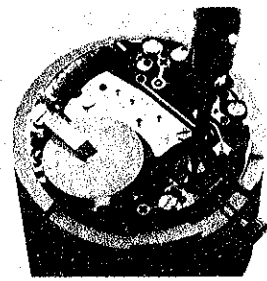

In cases where a frequent battery change is required, a current consumption test is recommended.

Use the following procedures:

- (1) Set up the Volt-ohm-meter.

- Range to be used DC 0.03 mA
- Set up the condenser kit (200 μ F ~ 500 μ F) as shown in the photo.

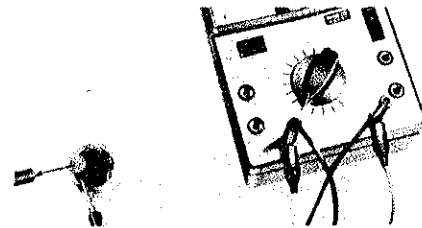

- (2) Measurement

Probe Red (+) Battery connection (+)

Probe Black (-) Battery surface (-)

Place the battery on the case back with its plus surface down.

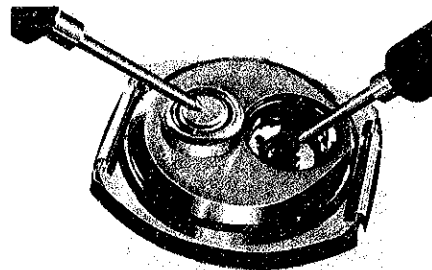

When the current consumption is measured in the condition of the watch movement (without case), place the battery on the third wheel bridge with its plus surface down.

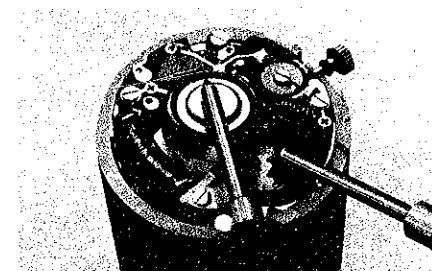

All procedures of assembling and reassembling, checking and adjustment are completed.