

SEIKO

QUARTZ









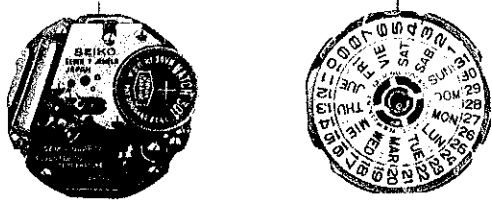

































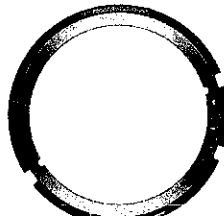
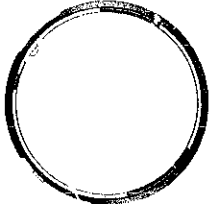
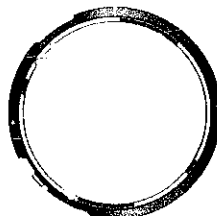



3003

(Cal. 4823A)

PARTS LIST

| | | |
|-----------------------------|---------------------|----------------------------------|
| Calibre No. 4823A | Jewels 7j | Style Name QUARTZ 3003 |
|-----------------------------|---------------------|----------------------------------|

| | |
|---|--|
|  | Characteristics : Casing diameter : 25.6 φmm Maximum height : 4.8 mm Frequency of quartz crystal oscillator : 32,768 Hz (Hz = Hertz Cycle per second) Driving system : Step motor system (6 poles) Regulation system : Trimmer condenser Rapid-second adjustment : Second hand stops to the next ten-second mark. Calendar (day & date) Instant setting device for day & date calendar Bilingual change-over system for day of week Battery life indicator : Second hand moves in two-second interval. |
|---|--|

| | | | | | | | |
|---|---|---|--|---|---|---|--|
|  122 680 |  131 680 |  221 680 |  225 680 |  231 680 |  241 680 |  261 611 | |
|  271 680 |  281 680 |  282 680 |  354 680 |  383 680 |  384 680 |  386 680 | |
|  389 680 |  390 560 |  391 680 |  ☆397 680 |  ☆397 681 |  444 680 |  480 680 |  526 680 |
|  556 838 |  760 680 |  ☆801 550 |  802 838 |  808 680 |  810 680 |  817 610 |  868 680 |
|  ☆870 852 |  873 680 |  ☆884 955 |  ☆884 957 |  ☆884 958 | | | |
|  963 838 |  980 680 |  981 680 |  ☆4001 700 |  4050 680 |  4002 680 | | |
|  4146 680 |  4216 836 |  4219 680 |  4239 680 |  4242 681 |  4455 680 |  U.C.C. 301 | |
|  | | | | | | | |

☆⇨ Please see remarks on the next reverse page.

| Calibre No. | | Jewels | Style Name | |
|------------------|--|------------------|------------------------------------|--|
| 4823A | | 7j | QUARTZ 3003 | |
| PART NO. | PART NAME | PART NO. | PART NAME | |
| 122 680 | Center wheel bridge | 022 468 | Setting wheel ring screw | |
| 131 680 | Third wheel bridge | 022 753 | Day jumper screw | |
| 221 680 | Center wheel & pinion | 022 753 | Date dial guard screw | |
| 225 680 | Cannon pinion | 022 761 | Dial screw | |
| 231 680 | Third wheel & pinion | 023 029 | Tube for circuit block | |
| 241 680 | Fourth wheel & pinion | 023 033 | Tube for third wheel bridge screw | |
| 261 611 | Minute wheel | 023 436 | Reset lever pin | |
| 271 680 | Hour wheel | 027 904 | Second jumper adjusting pin | |
| 281 680 | Setting wheel | 027 908 | Second setting lever adjusting pin | |
| 282 680 | Clutch wheel | U.C.C.301 | Silver oxide battery | |
| 354 680 | Winding stem | | | |
| 383 680 | Setting lever | | | |
| 384 680 | Yoke (Clutch lever) | | | |
| 386 680 | Setting lever spring | | | |
| 389 680 | Setting lever axle spring | | | |
| 390 560 | Setting lever axle | | | |
| 391 680 | Second-setting lever | | | |
| ☆ 397 680 | Lever for unlocking stem | | | |
| ☆ 397 681 | | | | |
| 444 680 | Upper frame for hole jewel of fourth wheel | | | |
| 460 680 | Setting wheel ring | | | |
| 526 680 | Second-setting wheel | | | |
| 556 838 | Date finger | | | |
| 760 680 | Second jumper | | | |
| ☆ 801 550 | Date dial | | | |
| 802 838 | Date driving wheel | | | |
| 808 680 | Date dial guard A | | | |
| 810 680 | Date jumper | | | |
| 817 610 | Intermediate date wheel | | | |
| 868 680 | Day finger | | | |
| ☆ 870 852 | Day star with dial disk | | | |
| 873 680 | Day jumper | | | |
| ☆ 884 955 | Holding ring for dial | | | |
| ☆ 884 957 | | | | |
| ☆ 884 958 | | | | |
| 963 838 | Snap for day star with dial disk | | | |
| 980 680 | Intermediate wheel for day-date correction | | | |
| 981 680 | Day-date corrector wheel rocker | | | |
| 4001 700 | Circuit block | | | |
| 4050 680 | Circuit bridge | | | |
| 4002 680 | Coil block | | | |
| 4146 680 | Step rotor | | | |
| 4216 836 | Insulator A for battery connection | | | |
| 4219 680 | Insulator B for battery connection | | | |
| 4239 680 | Rotor stator | | | |
| 4242 681 | Plus terminal of battery connection | | | |
| 4455 680 | Reset lever | | | |
| 011 406 | Upper hole jewel for fourth wheel | | | |
| 011 411 | Upper cap jewel for step rotor | | | |
| 011 411 | Lower cap jewel for step rotor | | | |
| 011 411 | Upper hole jewel for third wheel | | | |
| 011 411 | Lower hole jewel for third wheel | | | |
| 011 424 | Upper hole jewel for second setting wheel | | | |
| 022 282 | Date driving wheel screw | | | |
| 022 468 | Center wheel bridge screw | | | |
| 022 468 | Third wheel bridge screw | | | |
| 022 468 | Circuit block screw | | | |
| 022 468 | Coil block screw | | | |
| 022 468 | Setting lever axle spring screw | | | |
| 022 468 | Setting lever spring screw | | | |

☆⇨ Please see remarks on the reverse page.
Part numbers in light letters are not shown in photos.

| | | |
|---|---|--|
| Calibre No. <p style="text-align: center; font-size: 2em;">4823A</p> | Jewels <p style="text-align: center; font-size: 1.5em;">7j</p> | Style Name <p style="text-align: center; font-size: 1.2em;">QUARTZ 3003</p> |
|---|---|--|

Remarks :

Lever for unlocking stem

- ☆397 680.....Used for the one-piece type case with the dial whose external diameter is less than **27.5 mm** or used for the cases with dial shaped other than round.
- ☆397 681.....Used for the one-piece type case with the dial of **28.5 mm** external diameter.

Date dial

- ☆801 550.....Used when both the crown and the calendar frame are located at **3 o'clock** position.
 If any other type of date dial is required, specify ① Cal. No. ② the crown position ③ the calendar frame position and ④ the dial No.

Day star with dial disk

- ☆870 852(English↔Spanish, black figures on the white background).....Used when both the crown and the calendar frame are located at **3 o'clock** position.
 If any other type of day star with dial disk is required, specify the number printed on the disk.

Holding ring for dial

- ☆884 955.....Used only for the snap back case with the dial of **28.5 mm** external diameter.
- ☆884 957.....Used only for the one-piece type case with the dial of **27.5 mm** external diameter.
- ☆884 958.....Used only for the one-piece type case with the dial of **28.5 mm** external diameter.

The type of holding ring for dial is determined based on the design of cases and dials.
 Check the case number and refer to "**SEIKO Quartz Casing Parts List**" to choose a corresponding holding ring for dial.

TECHNICAL GUIDE

SEIKO QUARTZ CAL.4823A

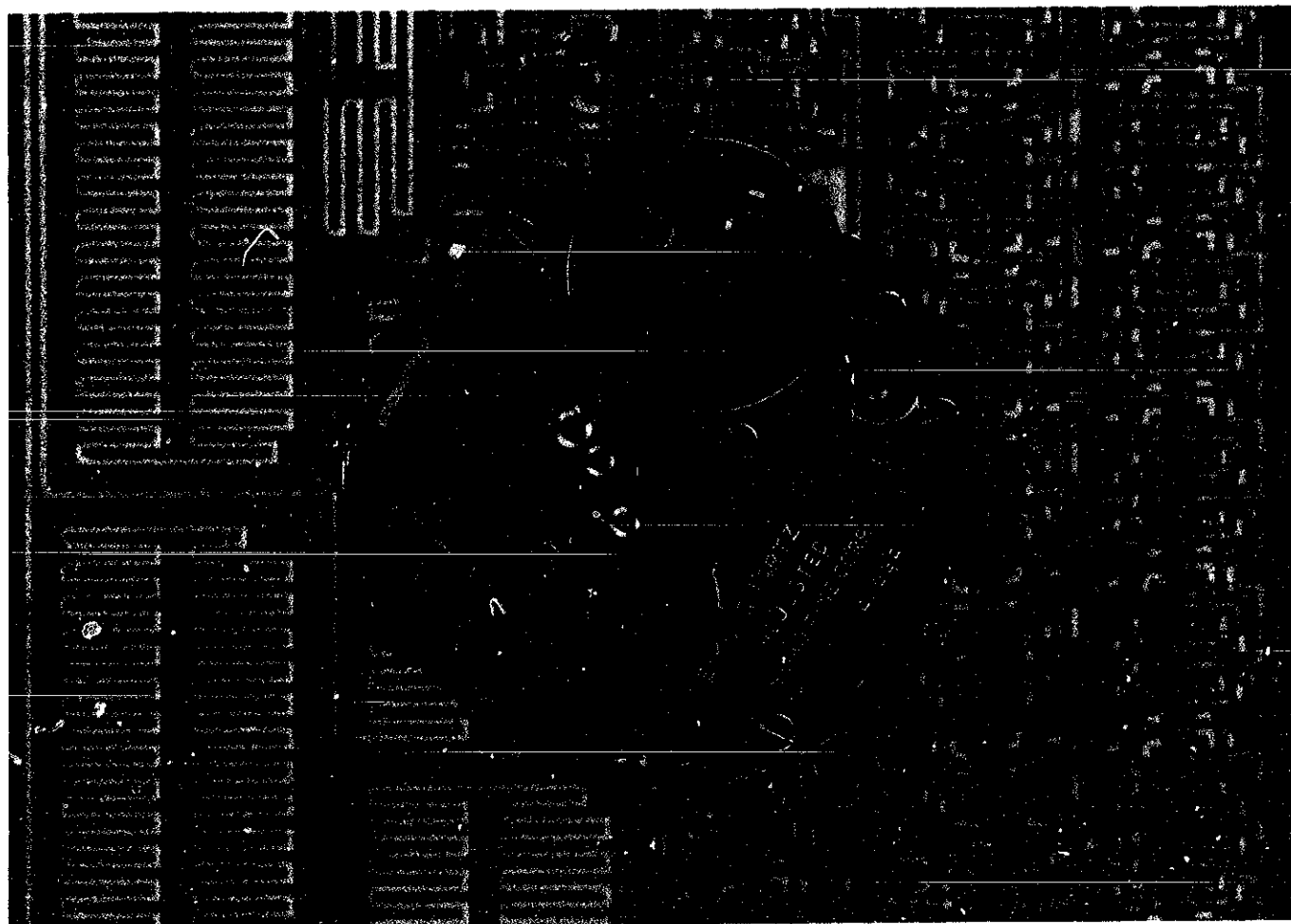

CONTENTS

| | |
|--|----|
| I. Specifications and Features | 2 |
| 1. Specifications | 2 |
| 2. Features | 2 |
| II. Functioning | 3 |
| 1. Movement structure | 3 |
| 2. Outline of functioning | 4 |
| 3. Functioning of electronic circuit block | 4 |
| 4. Functioning of mechanical portion | 6 |
| III. How to set the time and calendar | 8 |
| 1. Resetting time | 8 |
| 2. Resetting calendar | 8 |
| IV. Case Construction | 9 |
| 1. How to remove movement from one-piece type case | 9 |
| 2. How to fix snap type case back | 10 |
| 3. Battery replacement | 10 |
| V. After-sale Servicing Instruments and Materials | 11 |
| VI. Disassembling, Reassembling, Lubricating and Cleaning | 12 |
| 1. Disassembling, Reassembling and Lubricating | 12 |
| (1) Calendar and setting mechanism | 12 |
| (2) Circuit block, coil block and movement mechanism | 14 |
| (3) Setting mechanism | 16 |
| 2. Cleaning | 17 |

SEIKO QUARTZ CRYSTAL WATCH Cal. 4823

The SEIKO QUARTZ CRYSTAL WATCH Cal. 4823 has been developed using similar technology as the other SEIKO Quartz Calibres, which has already gained a reputation for its high accuracy and reliability.

The calibre grade of this watch is similar to that of the Calibre 38 series. Moreover, this watch has adopted new advanced devices—Battery Life Indicator and Rapid Advance Second Setting Adjustment.

| | |
|---|----|
| CHECKING AND ADJUSTMENT | 18 |
| 1. Guide for checking and adjustment | 18 |
| 2. Procedures for checking and adjustment | 20 |
| A: Check output signal | 20 |
| B: Check battery voltage | 20 |
| C: Check battery conductivity | 20 |
| D: Check reset switch | 22 |
| E: Check circuit block conductivity | 22 |
| F: Check circuit block output terminal conductivity | 22 |
| G: Check coil block | 24 |
| H: Check output signal | 24 |
| I: Check second setting lever | 24 |
| J: Check second jumper | 26 |
| K: Check second setting condition | 26 |
| L: Check reset condition | 28 |
| M: Check accuracy | 30 |
| Measuring current consumption | 30 |

Calibre 4823A



Movement

I. SPECIFICATIONS AND FEATURES

1. Specifications

| Item | Cal. No. | 4823A |
|---|----------|--|
| Additional mechanism | | Calendar (day & date) Bilingual change-over system for the day of the week Instant day and date setting Electronic circuit reset switch |
| Rapid advance second setting adjustment | | Second hand stops to the next ten-second mark |
| Battery life indicator | | Second hand moves in two-second intervals |
| Crystal oscillator | | 32,768 Hz (Hz = Hertz . . . Cycles per second) |
| Loss/gain | | Loss/gain at normal temperature Monthly rate: less than 10 seconds (Annual rate: less than 2 minutes) |
| Casing diameter | | φ 25.6 mm |
| Height | | 4.8 mm |
| Operational temperature range | | -10°C ~ +60°C (14°F ~ 140°F) |
| Driving system | | Step motor system (6 poles) |
| Regulation system | | Trimmer condenser |
| Battery power | | Battery life is over two years Silver oxide battery (U.C.C. 301) Voltage 1.5V |
| Jewels | | 7 jewels |

2. Features

- (1) Cal. 4823A inherits the excellent reliability and durability of the SEIKO analogue type watches with quartz crystal oscillator already marketed.
 - (a) The quartz crystal oscillator because of its special shape generates a stabilized oscillation of 32,768 Hz.
 - (b) Second step system by step motor with stability and durability.
 - (c) Simplified block system facilitates easy after-sale servicing.
- (2) Rapid advance second setting system automatically moves the second hand to the next ten-second mark when the crown is pulled out. Therefore, time can be easily adjusted in accordance with the time signal of TV, radio and telephone.
- (3) Battery life indicator lets the second hand leap every 2 second when the battery life is coming to its end. This indicates the battery must be replaced. However, the watch keeps a correct time.
- (4) The movement is specially designed so that the battery will last for two years, although it uses an existing popular watch battery (U.C.C. 301).
- (5) A new bayonet type battery hatch facilitates easy replacement of battery.

II. FUNCTIONING

1. Movement structure

The movement consists of the circuit block, coil block, battery and the mechanical portion, of which the main component are a

step motor and a gear train. Since each portion is a separate unit, easy checking and adjustment is possible.

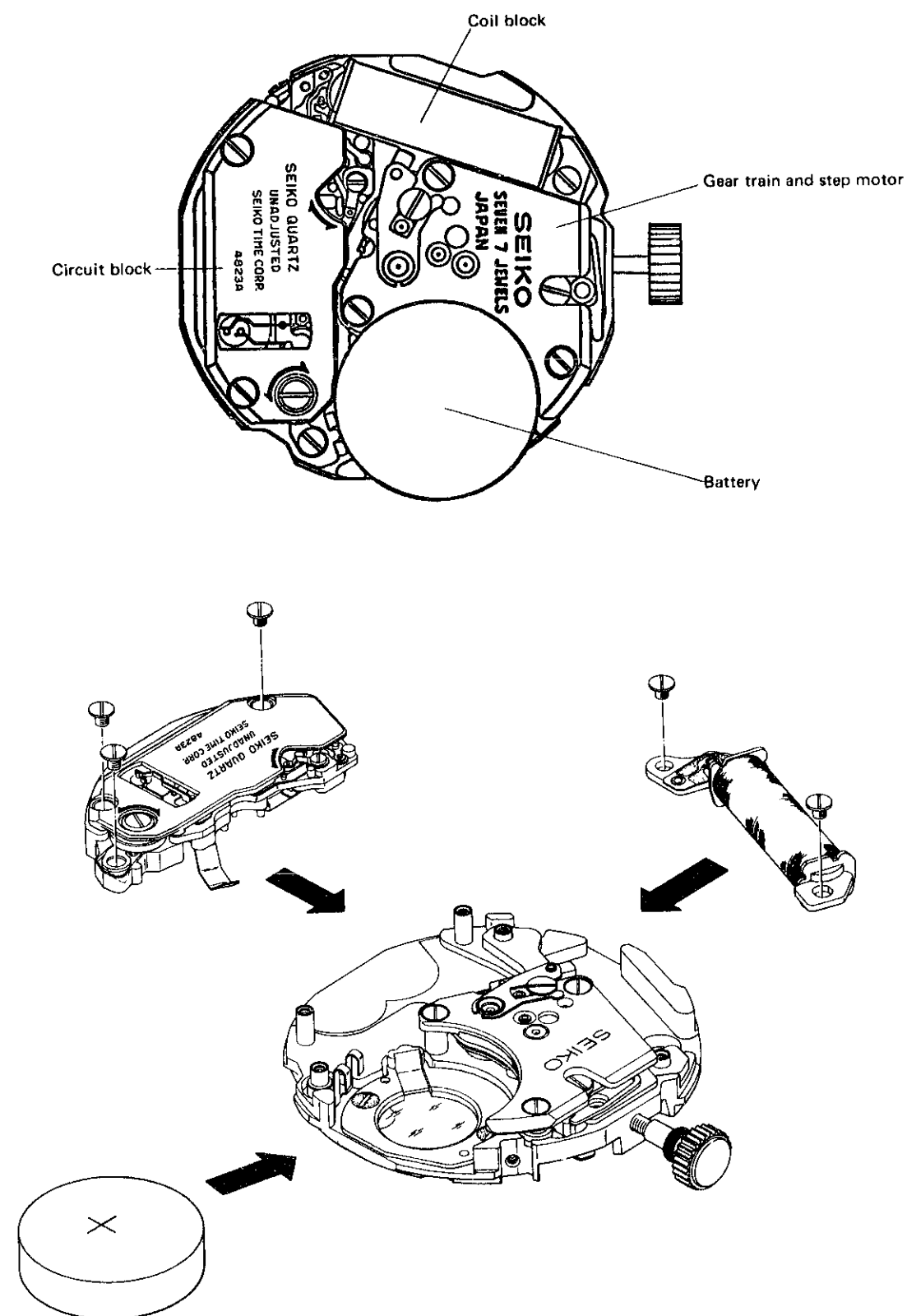

2. Outline of functioning

- (1) The quartz crystal oscillator, built in the crystal unit, oscillates accurately at 32,768 Hz.
- (2) The circuit unit receives the 32,768 Hz oscillations (electronic signals) and converts them into impulses at the rate of one per second, i.e. 1/2, 1/2, 1/2. . . .

- (3) The one-per-second signals are transmitted to the coil block, causing the step motor to momentarily rotate once every second in 60° increments.
- (4) This rotation is transmitted to the gear train thus moving the hands.

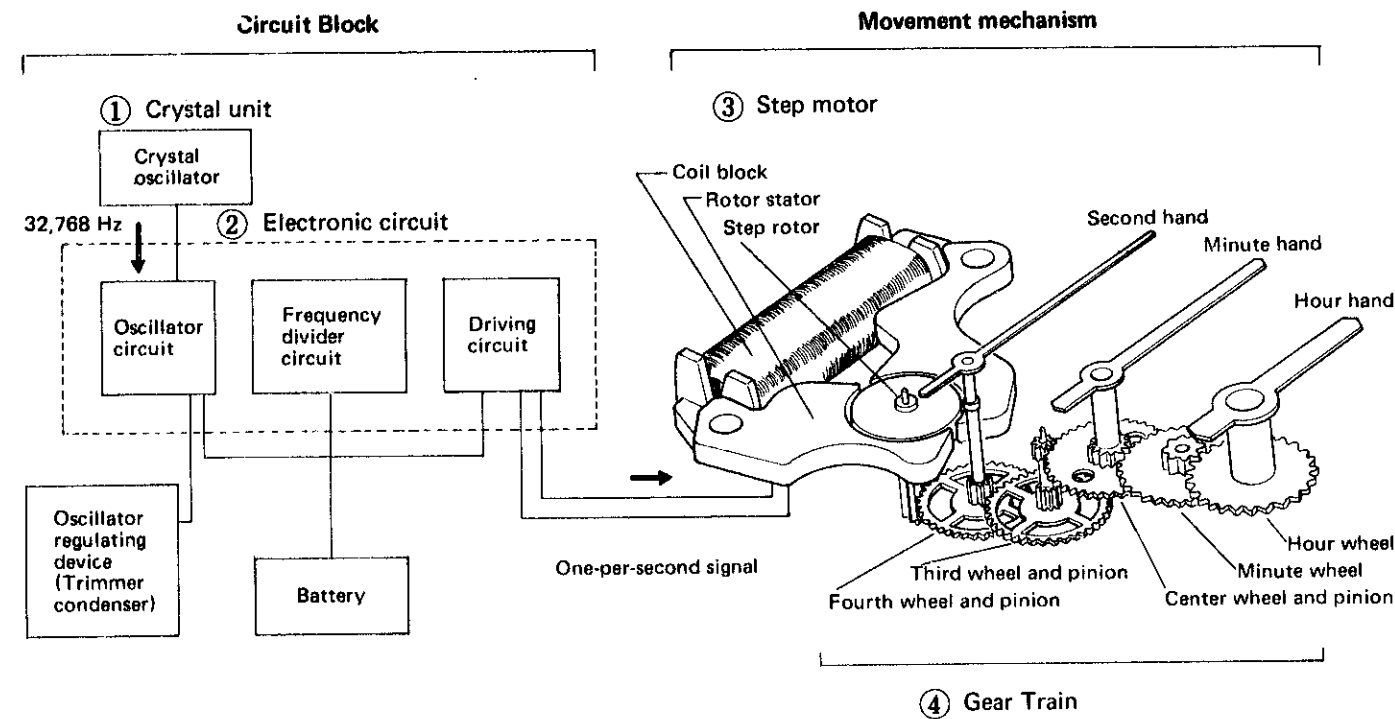

3. Functioning of electronic circuit block

(1) Circuit block

- The quartz crystal oscillator uses the SEIKO ultrasmall tuning fork shape and is housed in a flat-type vacuum capsule.

When voltage is supplied from the electronic circuit, the crystal oscillator makes stabilized oscillation exactly at 32,768 Hz which is the source of the high accuracy obtained in Cal. 4823A watch.

- A MOS IC of high reliability is used in the electronic circuit. The electronic circuit supplies voltage to the crystal oscillator to cause it to oscillate at 32,768 Hz and at the same time it takes out the oscillation in the form of an electrical signal. The oscillation of

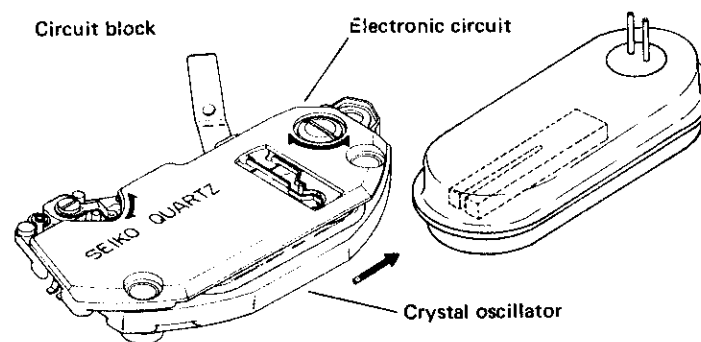

32,768 Hz is successively divided into 1/2 to finally obtain a signal per second, which is transmitted to the step motor.

(2) Oscillator regulating device

Adjustment of the oscillator of Cal. 4823A watch can be easily made by simply turning the trimmer condenser.

- Function of the Trimmer Condenser

The trimmer condenser consists of a rotor electrode and a stator electrode. Turning the shaft fixed to the rotor changes the overlapped area between the rotor electrode and stator electrode, which in turn changes the capacitance of the trimmer condenser. Turning the trimmer condenser changes its capacitance as shown in the diagram. Time is adjusted by the magnitude of this change.

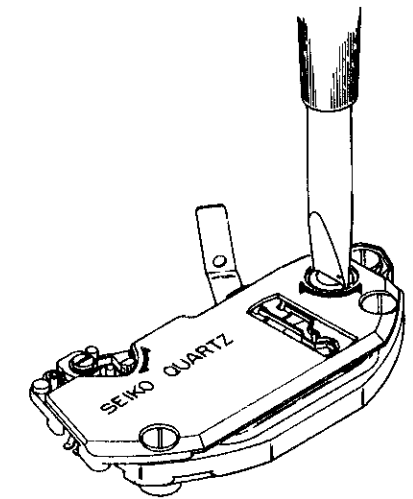

○ Checking accuracy cannot be made with conventional mechanical wrist-watch testers. It is necessary to use the QUARTZ TESTER.

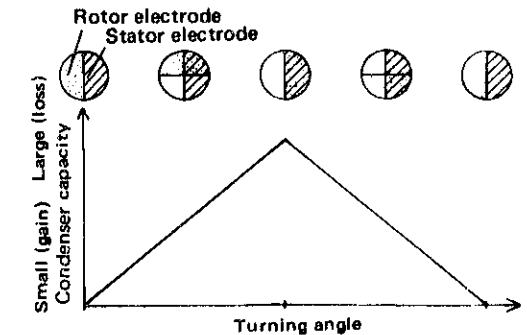
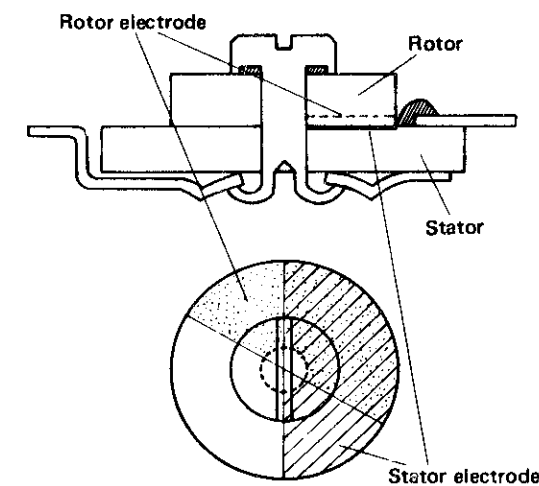

4. Functioning of mechanical portion

(1) Step motor

One of the features of these watches is the SEIKO step motor which changes the vibrations of the crystal oscillator into a rotating motion. The step motor consists of a coil block, a rotor stator and a step rotor. The rotor stator is made of materials having a high conductivity of magnetic force.

The step rotor is a circular-shaped permanent magnet having six alternately imposed N and S poles.

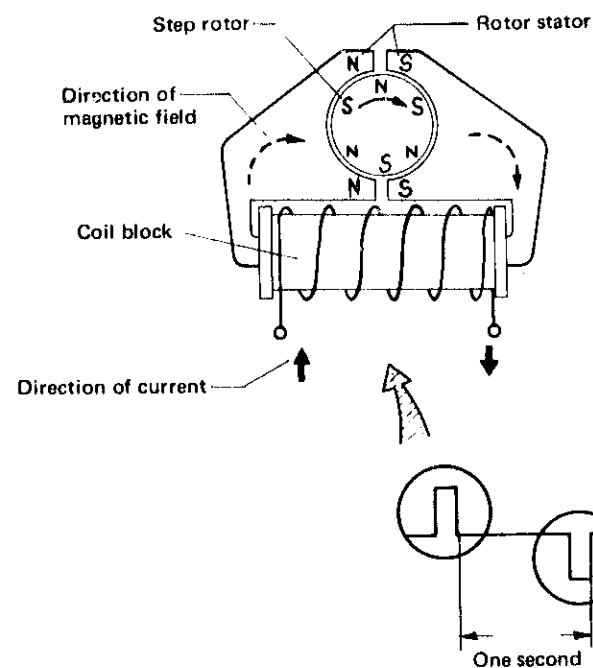
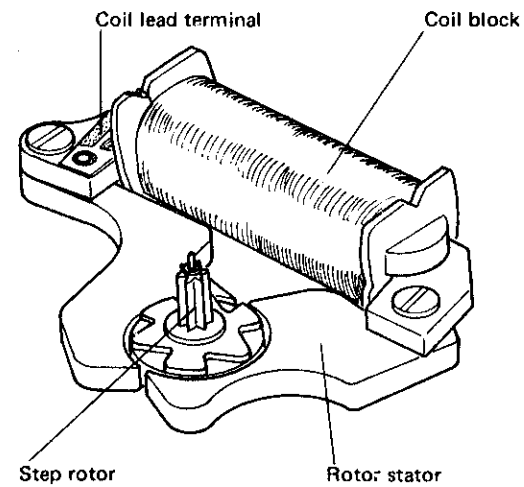

Operational sequence

- (1) Current flows in the coil block
The current, of which the flow direction is changed once every second, is transmitted from the circuit block into the coil block.
- (2) Rotor stator becomes magnet
When current flows in the coil block, the rotor stator becomes magnet and the tip portions become, respectively, N and S poles.
- (3) Step rotor rotations
The N and S poles of the rotor stator tips and the N and S poles of the step rotor alternately repel and attract causing

the step rotor to rotate in 60° increments in a constant direction once every second.

- (4) Rotation of the second hand
Rotation of the step rotor is transmitted to the fourth wheel and pinion which gears with the pinion of the step rotor. The rotation of the fourth wheel and pinion is finally transmitted to move the second hand.

(2) Second setting and reset switch

Cal. 4823A has the rapid advance second setting adjustment device and the reset switch for accurate time setting and second hand can

be set rapidly and accurately in accordance with the time signal.

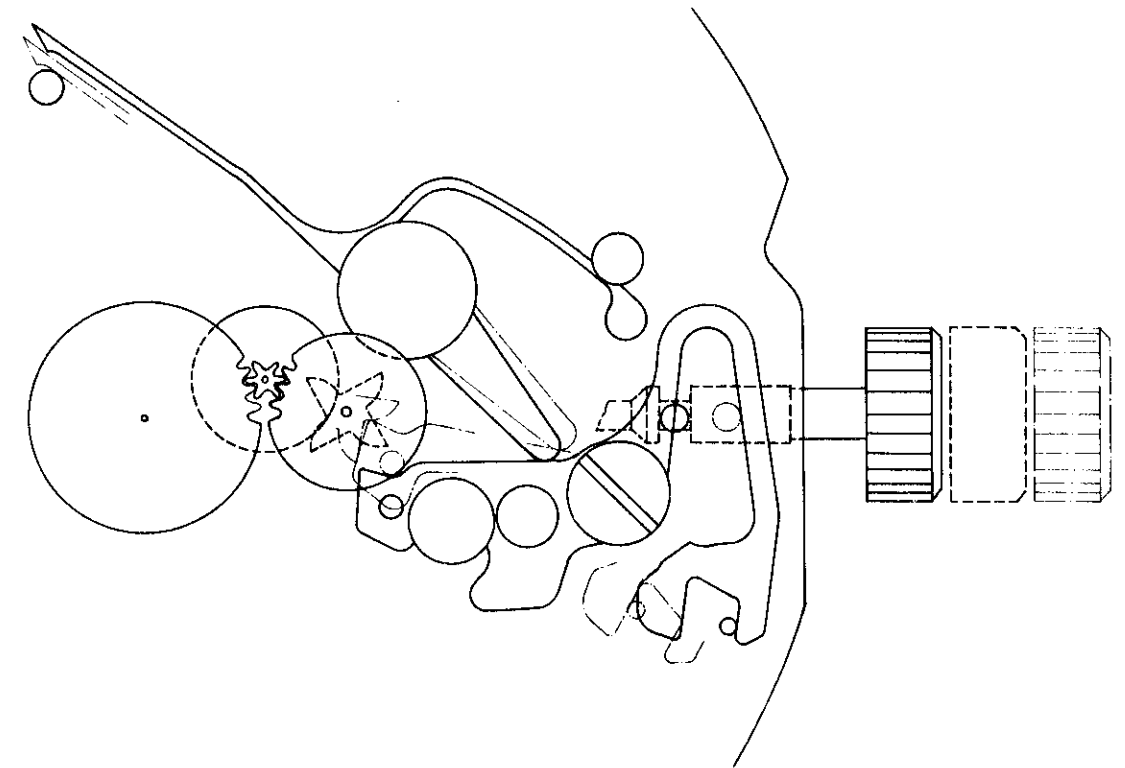

- Rapid advance second setting adjustment
When the crown is pulled out to the 2nd click, the driving pin for second setting lever will function to reset the cam of the second setting wheel. Thus, the second hand will stop at every 10 second position ahead (0, 10, 20, 30, 40, 50 second).
Ex. If the crown is pulled out to the 2nd click when the second hand is between 51 to 0 second position, the second hand will leap and stop at 0 second position.

- Reset switch
When the second setting lever functions and the second hand stops, the reset lever touches the circuit block reset pin and reset function starts.
The watch stops when the reset switch functions but the current from the battery flows to the crystal oscillator and a part of the electronic circuit and the watch is ready to restart.

III. HOW TO SET THE TIME AND CALENDAR

• Crown position

- Normal position: Free
- 1st click: Change of day and date
 - Date change . . . clockwise (turn away from you.)
 - Day change . . . counterclockwise turn toward you.)
- 2nd click: Hand setting, reset switch and second setting

1. Resetting time

- (1) Pull the crown out to the 2nd click and the second hand stops at every 10 second position ahead.
- (2) Turn the crown and set the time of the hour hand and minute hand.
 - First turn the hour hands past the 12 o'clock position to see if the date changes, then set the time correctly. (Allow for the AM & PM period so that the date will change at midnight.)
 - As the torque of the gear train is transmitted reversely, the time is set accurately by turning the hands between 5 to 10 minutes ahead and then turning it back to the desired time.

- (3) In accordance with the time signal, push the crown in. Rapid second adjustment facilitates easy time adjustment in accordance with the time signal of TV, radio and telephone.

Push the crown in to the innermost position to start the watch. Then the hour, minute and second hand can be set exactly.

2. Resetting calendar

- Pull the crown out to the 1st click. Select the desired language as two languages appear alternately when setting the day of the week.

If the setting of the calendar is made when the hour hand is pointing to the time between 9:30 pm and 2:00 am, sometimes the calendar will not change the next day. The setting must therefore be made before or after this time period.

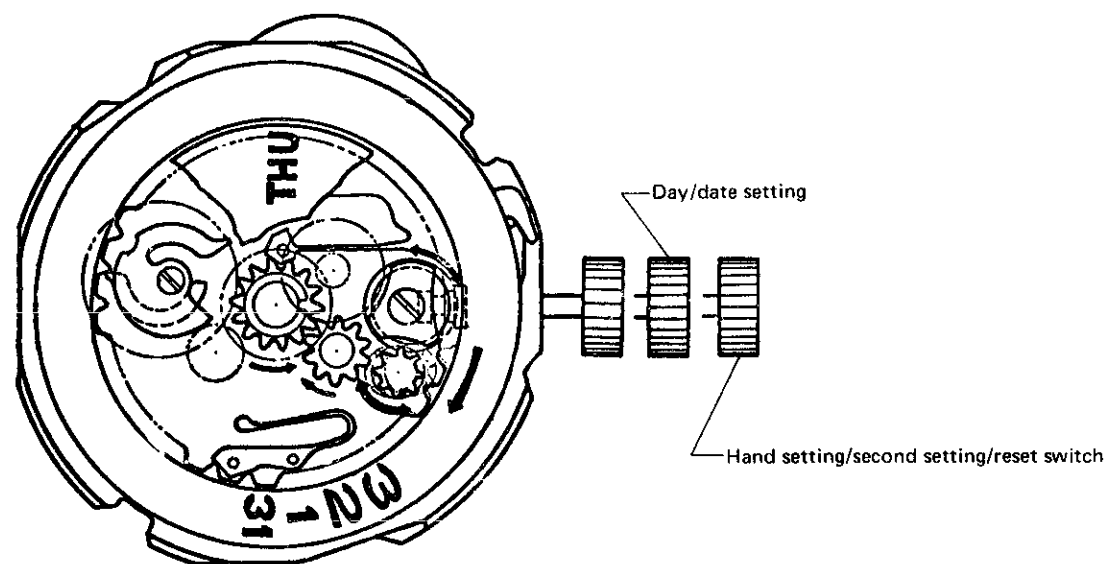

IV. CASE CONSTRUCTION

The case is water-resistant, and has the bayonet type battery hatch on the case back for easy battery replacement. There are two types of case construction, snap type case back and one-piece type.

Electric current flows from the (+) surface of the battery in the direction shown by the arrow mark (→).

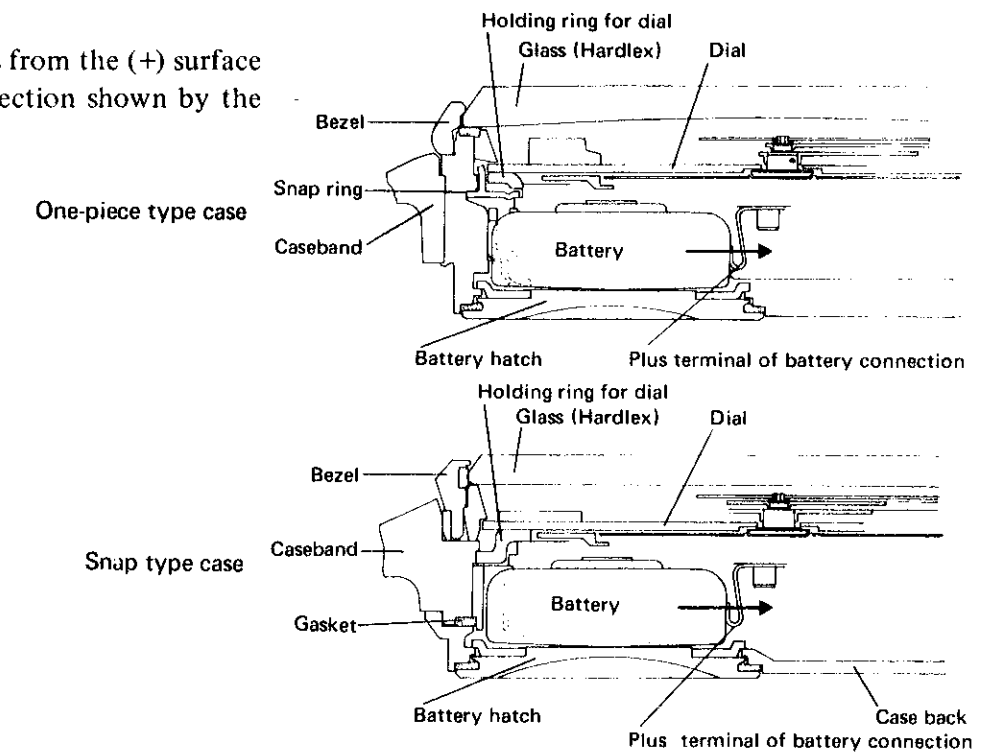

1. How to remove the movement from the one-piece type case

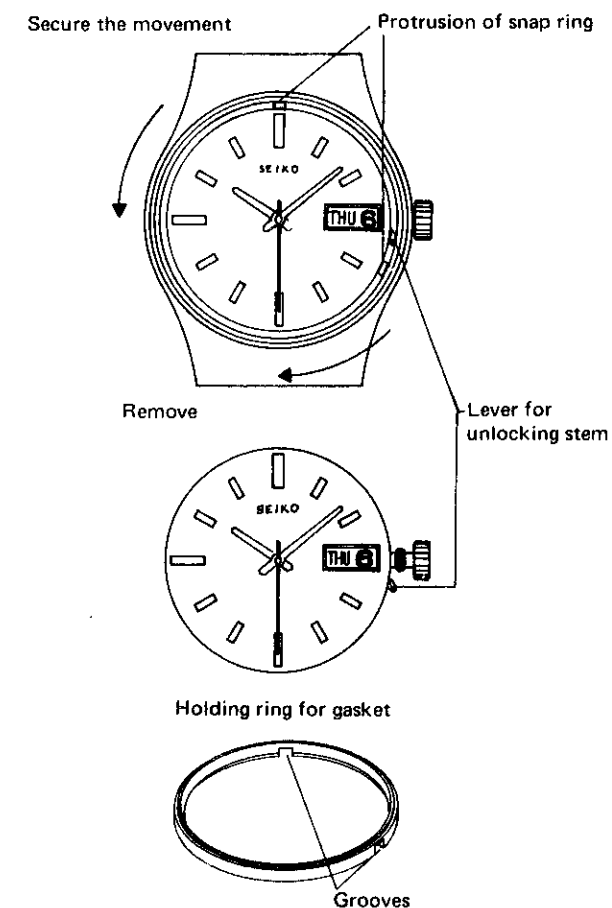

Turn the snap ring to remove the movement as it is fixed with the snap ring.

Although there are two protrusions of snap ring, one is located close to the dial of 4 o'clock position and the other is located close to the dial of 12 o'clock position, push the protrusion located at the 4 o'clock position toward the arrow-marked direction when turning the snap ring.

Push in the setting lever when the winding stem is pulled out.

Be careful not to scratch the outer circle of dial both when the snap ring is turned and the setting lever is pushed down as the clearance between the dial and the case is very small.

Turn the protrusion of snap ring located close to the dial of the 12 o'clock position toward the arrow-marked direction when re-assembling and tighten the movement.

When the holding ring for gasket is mounted on the dial, fit its groove to protrusions of snap ring.

V. AFTER-SALE SERVICING INSTRUMENTS AND MATERIALS

2. How to fix the snap type case back

• Alignment mark

Bring the line of both alignment mark on the caseband and case back in order to fix the case back as shown in the illustration, and then the battery hatch position is also fixed accordingly.

• Construction of the glass portion

The construction of the glass portion of the snap type case back of Cal. 4823 is shown in the illustration on page 9.

The "G" mark (water resistant G) is engraved on the snap type case back of Cal. 4823. (Snap type case back models are 4823-8029, 4823-8039 and 4823-8049 as of January 1976)

When disassembling and reassembling are needed, refer to the snap No. 4 of "Casing" item on the mechanical SEIKO watch Technical Guide Book.

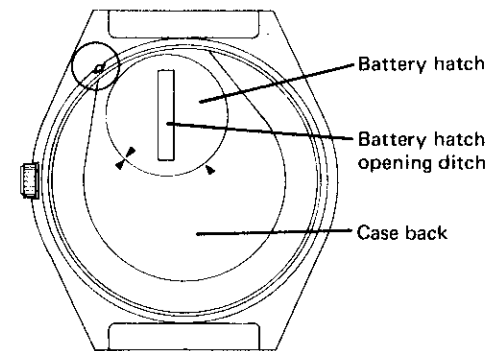

3. Battery replacement

The second hand will serve as a battery life indicator. The battery needs to be replaced when you see the second hand moving in two second interval instead of the normal one second interval. This indicates that the battery life will expire in one week. The watch, however, remains accurate during the one week period.

All the models of Cal. 4823 are equipped with a bayonet type battery hatch for easy replacement of the battery.

Remarks:

The battery does not come out by itself from the battery housing when the battery hatch is opened as the battery is held with a battery connection spring.

Therefore, remove the battery by using non-metallic tweezers.

For repair servicing, the following SEIKO after-sale servicing instruments and materials are necessary.

These instruments and materials are available at the head office of SEIKO.

1. Quartz Tester

Used to check time accuracy (daily rates) and flow of current from circuit block.

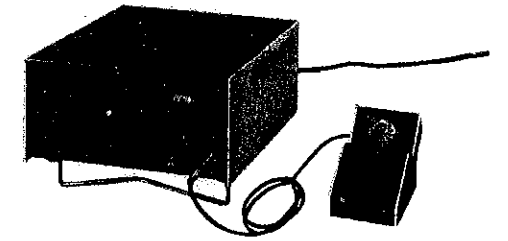

Quartz tester

2. Volt-ohm-meter

Used for checking battery voltage, measuring resistance and conducting conductivity test.



Volt-ohm-meter

3. Movement holder (S-651)

Used for disassembling, reassembling, checking and adjusting the movement.

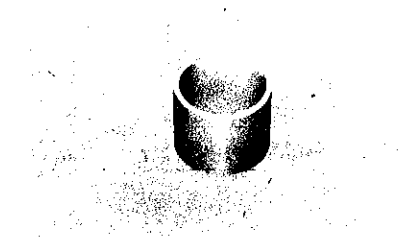

Movement holder S-651

4. Others

- (1) Anti-magnetic tweezers for handling step rotor.
- (2) Non-metallic tweezers for handling battery.

VI. DISASSEMBLING, REASSEMBLING, LUBRICATING AND CLEANING

1. Disassembling, Reassembling and Lubricating

- Disassembling and Reassembling

Disassembling procedures Figs.: ① → ④⑨

Reassembling procedures Figs.: ④⑨ → ①

- For the items marked with ► in disassembling and reassembling diagrams, refer to "CHECKING AND ADJUSTMENT".

(1) Disassembling, reassembling and lubricating of the calendar and setting mechanism

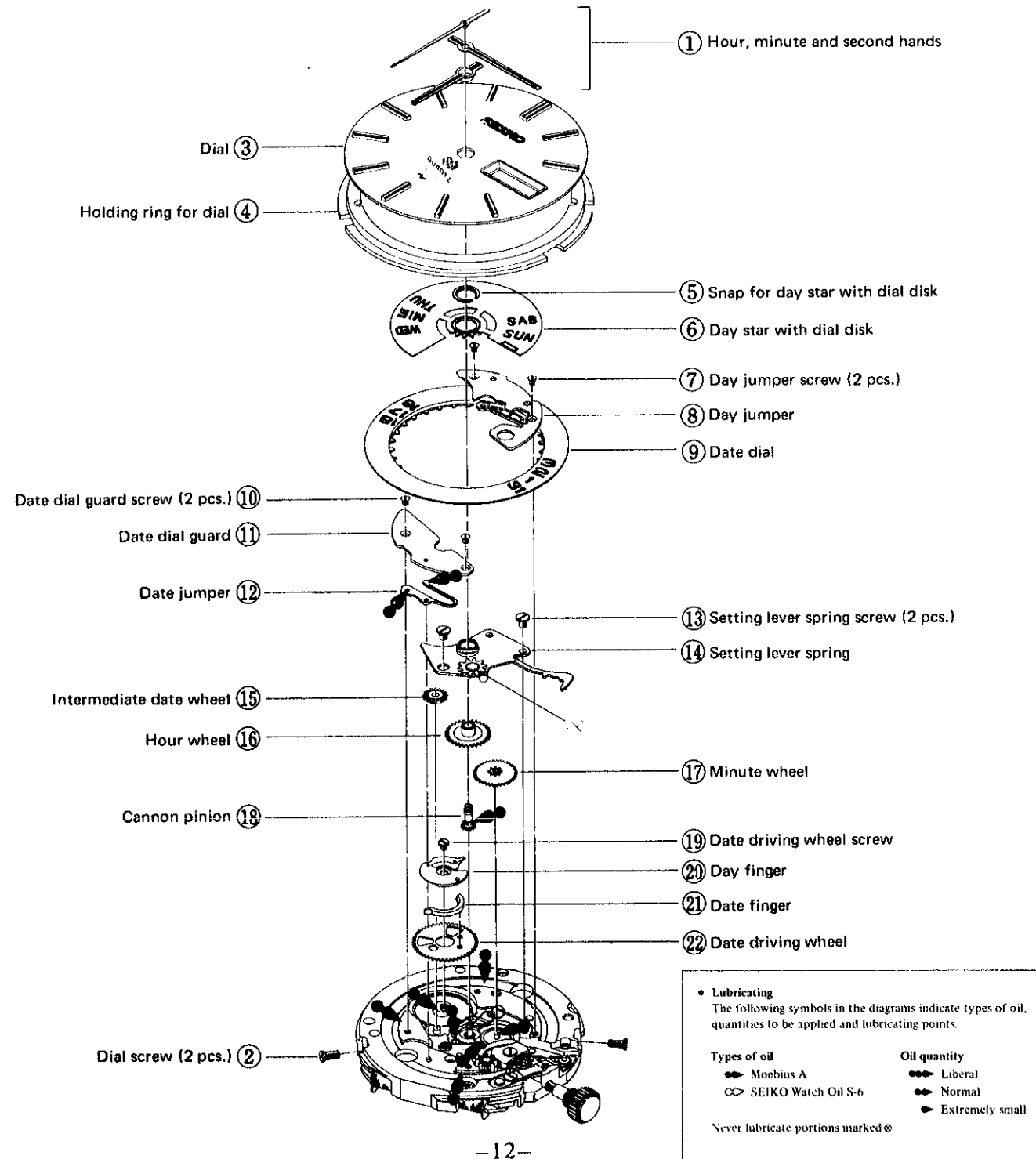

Remarks for disassembling and reassembling:

Hour, minute and second hands ①

- Pull out the crown to the 2nd click before putting on or removing the hands.
- Put the second hand just on the ten-second mark (0, 10, 20 . . . 50 sec.).
- After placing the second hand, follow the procedures:

K CHECK SECOND SETTING CONDITION and **L** CHECK RESET CONDITION.

Holding ring for dial ④

Set up these two parts for easy reassembling work.

Setting lever spring ⑭

- After reassembling check the crown condition (operation by pulling out and pushing in), reset conditions, hand-setting conditions.
- Intermediate wheel for day correction (it is touched to the setting lever spring.)

Hour wheel ⑯

Reassembling the hour wheel so that it doesn't touch the day finger.

Date driving wheel ㉒

In reassembling, do not mistake the obverse and reverse for each other.

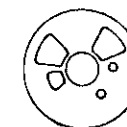

Front

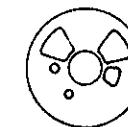

Back