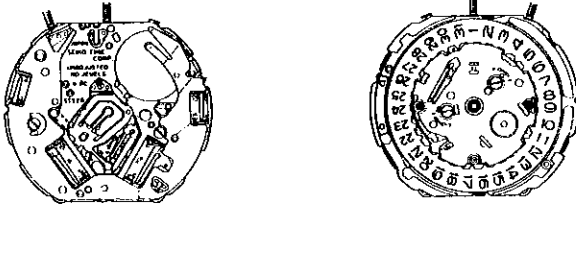

PARTS CATALOGUE/ TECHNICAL GUIDE

Cal. 5T52A

[SPECIFICATIONS]

Item		Cal. No.	5T52A		
Movement					
Movement size	Outside diameter	$\phi 27.6\text{mm}$ 24.0mm between 3 o'clock and 9 o'clock sides			
	Casing diameter	$\phi 27.0\text{mm}$ 24.0mm between 3 o'clock and 9 o'clock sides			
	Height	3.1mm (3.2mm including the battery portion)			
Time indication		Main time	Alarm function	World time function	
		Hour, minute and small second hands	Small hour and minute hands	City hand and small hour and minute hands	
Driving system		Step motor, 4 pieces			
Additional mechanism		<ul style="list-style-type: none"> • Electronic circuit reset switch • Train wheel setting device • Battery life indicator (Small second hand moves at two-second intervals.) • Date calendar • Instant setting device for date calendar • Alarm function (12-hour indication system) <ul style="list-style-type: none"> • Regular alarm • Single-time alarm • World time function (24-hour indication system) <ul style="list-style-type: none"> • Selection among 24 cities in different time zones • Adjustment of the city hand 			
Loss/gain		Monthly rate at normal temperature range: less than 15 seconds			
Regulation system		Nil			
Measuring gate by quartz tester		Use 10-second gate.			
Battery		SEIKO SR927W, Maxell SR927W, SONY SR927W, EVEREADY 399 Battery life is approximately 2 years. Voltage: 1.55V			
Jewels		0 jewel			

PARTS CATALOGUE

Cal. 5T52A

Disassembling procedures Figs.: ① → ⑧②

Reassembling procedures Figs.: ⑧② → ①

Lubricating: Type of oil

● Moebius A

○ SEIKO Watch Oil S-6

Oil quantity

○ Normal quantity

◁ Extremely small

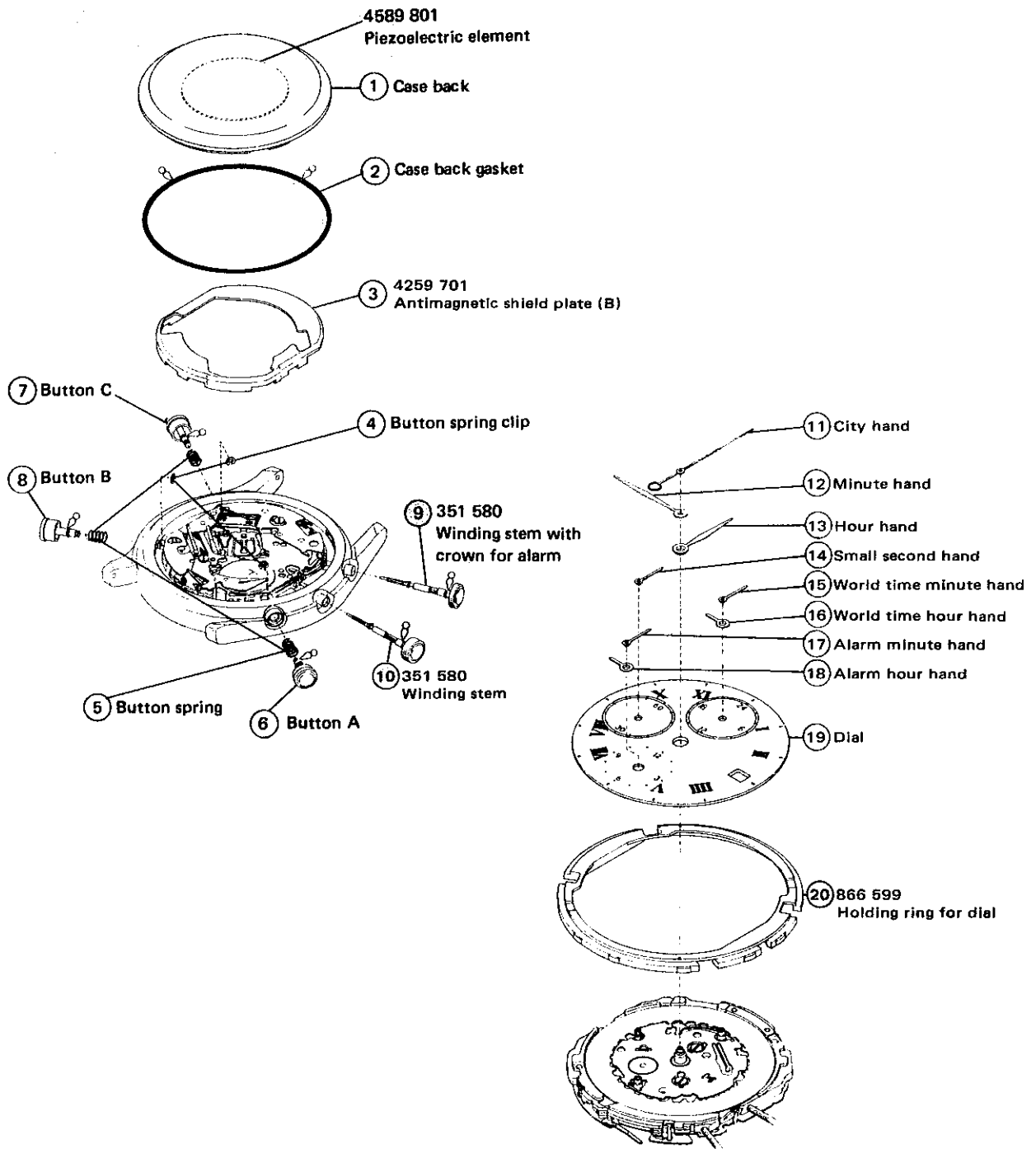

○ → Please see the remarks on the following pages.

PARTS CATALOGUE

Cal. 5T52A

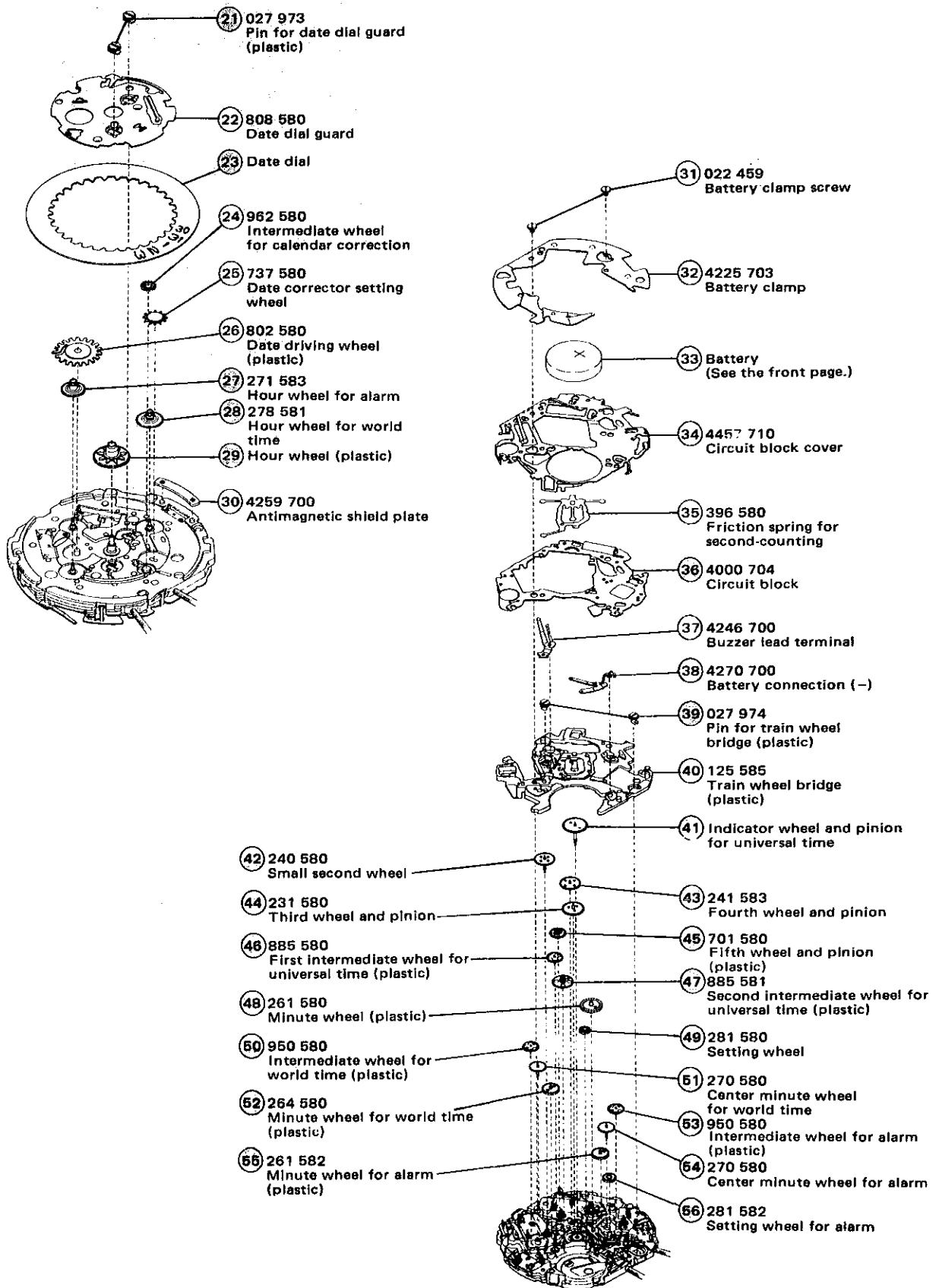

○ ➔ Please see the remarks on the following pages.

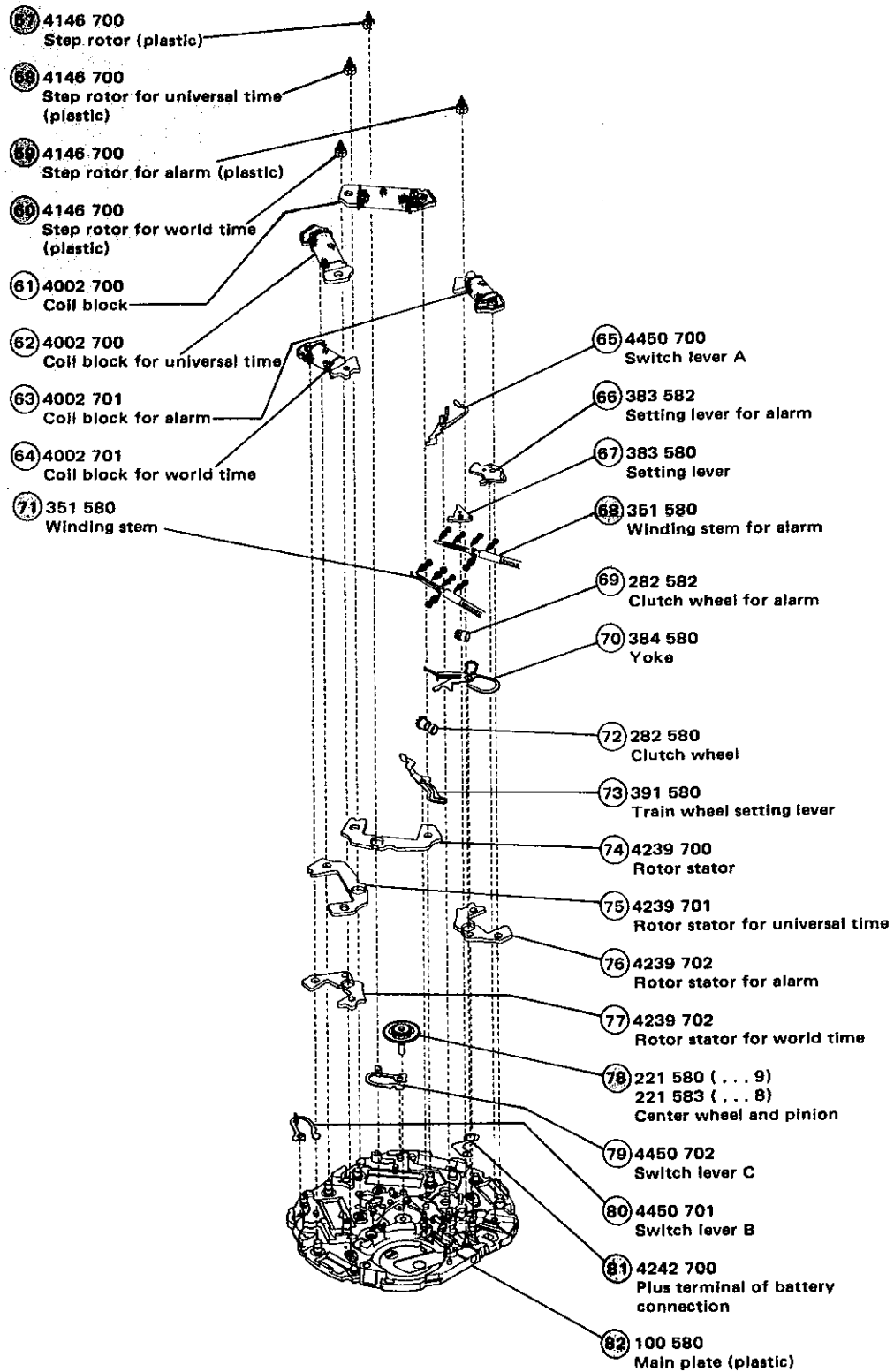

○ ➔ Please see the remarks on the following pages.

Remarks:

Cal. 5T52A, 7T32A and 7T42A are almost the same in structure but different in function. Therefore, some of the parts are named differently depending on calibres though they can be used interchangeably. There are also some parts that are not used with Cal. 7T32A or 7T42A but only with Cal. 5T52A.

- Parts used only with Cal. 5T52A

Parts code	Parts name
264 580	Minute wheel for world time
278 581	Hour wheel for world time
4242 700	Plus terminal of battery connection

- Parts named differently depending on calibres.

Parts code	Parts name for Cal. 7T42A	Parts name for Cal. 5T52A
270 580	Center minute wheel for alarm	Center minute wheel for world time
888 582	Second-counting wheel	Indicator wheel and pinion for universal time
885 580	First intermediate wheel for second-counting	First intermediate wheel for universal time
885 581	Second intermediate wheel for second-counting	Second intermediate wheel for universal time
950 580	Intermediate minute-counting wheel	Intermediate wheel for world time
4146 700	Chronograph rotor for second Chronograph rotor for minute	Step rotor for universal time Step rotor for world time
4002 700	Coil block for chronograph second Coil block for chronograph minute	Coil block for universal time Coil block for world time
4239 701	Rotor stator for chronograph second	Rotor stator for universal time
4239 702	Rotor stator for chronograph minute	Rotor stator for world time

⑨ ⑥⑧ Winding stem for alarm 351 580

⑩ ⑦① Winding stem 351 580

The type of winding stem for alarm and winding stem are determined based on the design of cases. Check the case number and refer to "SEIKO Casing Parts Catalogue" to choose a corresponding winding stem.

⑳ Holding ring for dial 866 599

The type of holding ring for dial is determined based on the design of cases. Check the case number and refer to "SEIKO Casing Parts Catalogue" to choose a corresponding holding ring for dial.

㉑ Pin for date dial guard

㉓ Pin for train wheel bridge

For distinction between the pins, see the illustration below.

[Pin for date dial guard]



027 973

[Pin for train wheel bridge]

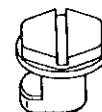

027 974

PARTS CATALOGUE

Cal. 5T52A

- ②③ Date dial 878 527, 878 528, 878 529, 878 536

The type of date dial is determined based on the design of cases.
Check the case number and refer to "SEIKO Casing Parts Catalogue" or "List of Date Dial" to choose a corresponding date dial.

- ②⑦ Hour wheel for alarm
②⑧ Hour wheel for world time

For distinction between the two hour wheels, see the illustration below.

[Hour wheel for world time]

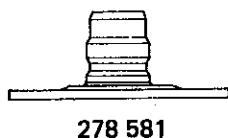

278 581

[Hour wheel for alarm]

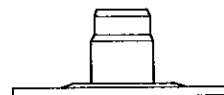

271 583

- ②⑨ Hour wheel
④① Indicator wheel and pinion for universal time
⑦⑧ Center wheel and pinion

	Center wheel and pinion	Indicator wheel and pinion for universal time	Hour wheel
S	<p>221 580</p>	<p>888 580</p>	<p>271 580</p>
M	<p>221 583</p>	<p>888 582</p>	<p>271 588</p>

③⑥ Circuit block

See the illustration below to identify the circuit block for Cal. 5T52A.

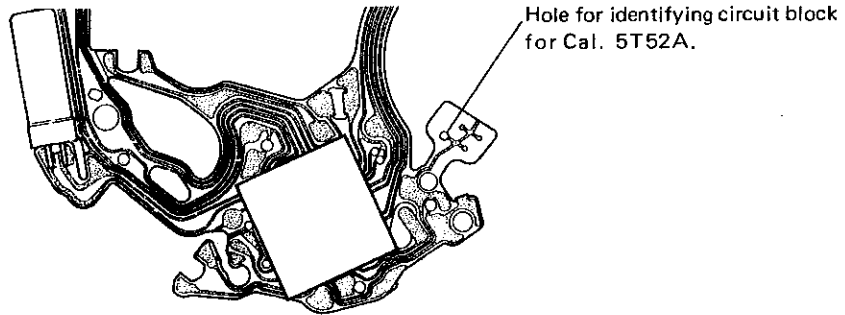

⑤① Center minute wheel for world time 270 580

Center minute wheel for world time is used as the center minute wheel for alarm in Cal. 7T42A movement. It is set in the position where the minute-counting wheel is installed in Cal. 7T42A.

⑤② Minute wheel for world time

⑤⑤ Minute wheel for alarm

For distinction between the two minute wheels, see the illustration below.

[Minute wheel for world time]

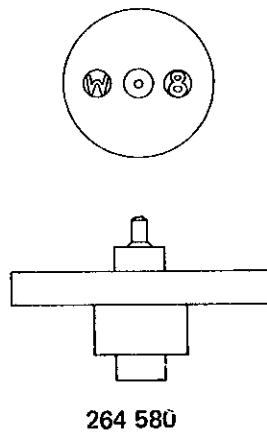

[Minute wheel for alarm]

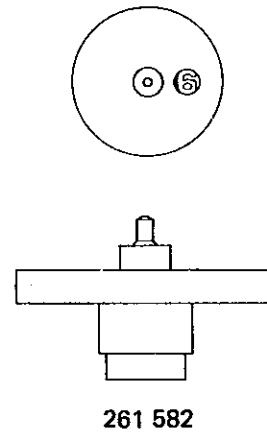

Cal. 5T52A, 7T32A and 7T42A are almost the same in structure.

- The explanation here is only for the particular points of Cal. 5T52A.
For other information refer to the "PARTS CATALOGUE/TECHNICAL GUIDE Cal. 7T32A" and the "TECHNICAL GUIDE, GENERAL INSTRUCTIONS".

I. POINTS OF DIFFERENCE BETWEEN Cal. 7T32A AND Cal. 5T52A

1. Difference in function

- i) Specifications of the CPU-1C have been changed and Cal. 5T52A is equipped with a world time function instead of a stopwatch function.
- ii) Cal. 5T52A is provided with single-time alarm and regular alarm functions.

2. Difference in structure

Following parts are not used with Cal. 7T32A but with Cal. 5T52A.

- ②8 Hour wheel for world time
- ⑤2 Minute wheel for world time
- ⑧1 Plus terminal of battery connection

- **Setting position of the plus terminal of battery connection**

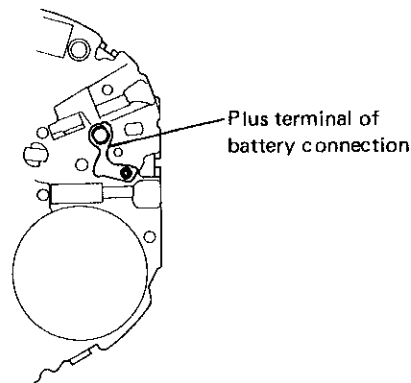

3. Remarks that pertain to Cal. 5T52A only

- ③9 Pin for train wheel bridge

- **Lubricating**

Lubricate the upper pivot of each step rotor as shown in the illustration.

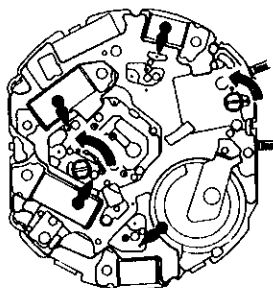

④① Indicator wheel and pinion for universal time

⑥① Step rotor for world time

● **Setting position**

See the illustration below.

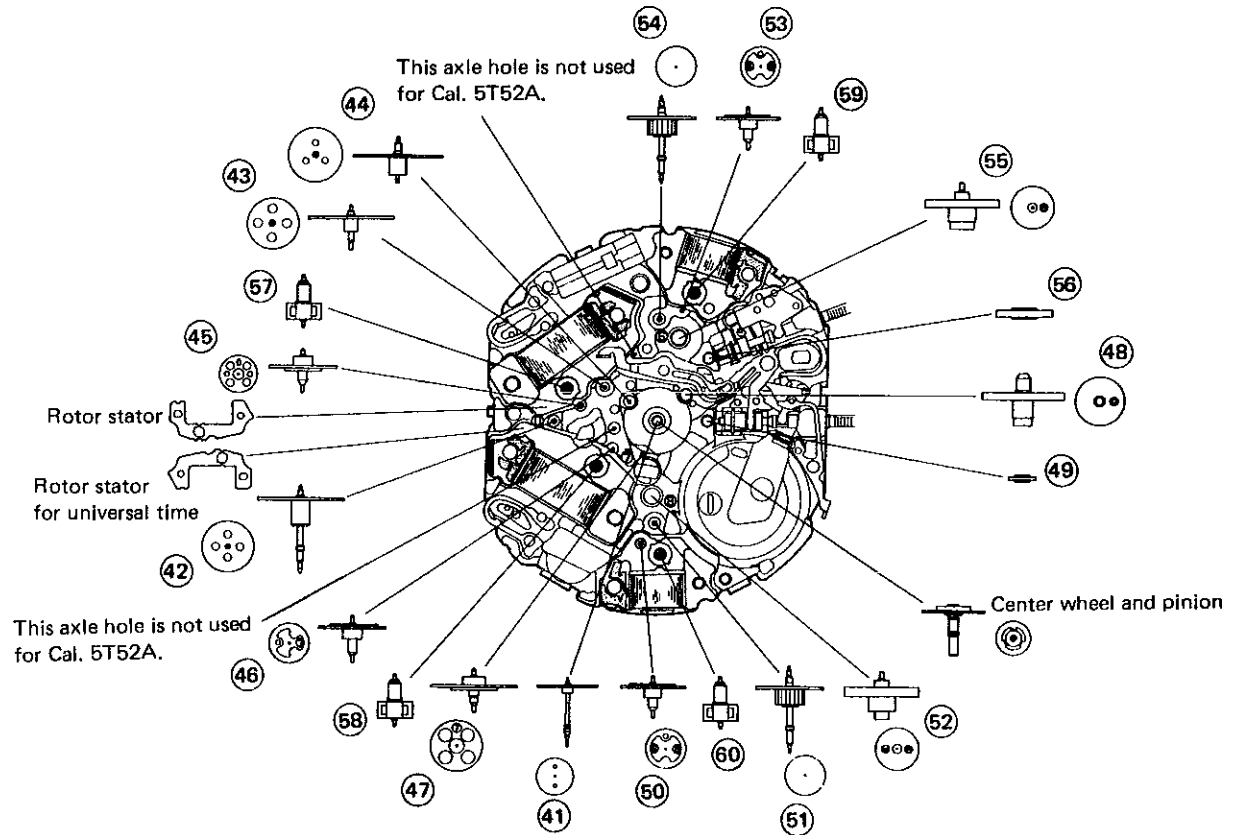

⑧② Main plate

● **Lubricating**

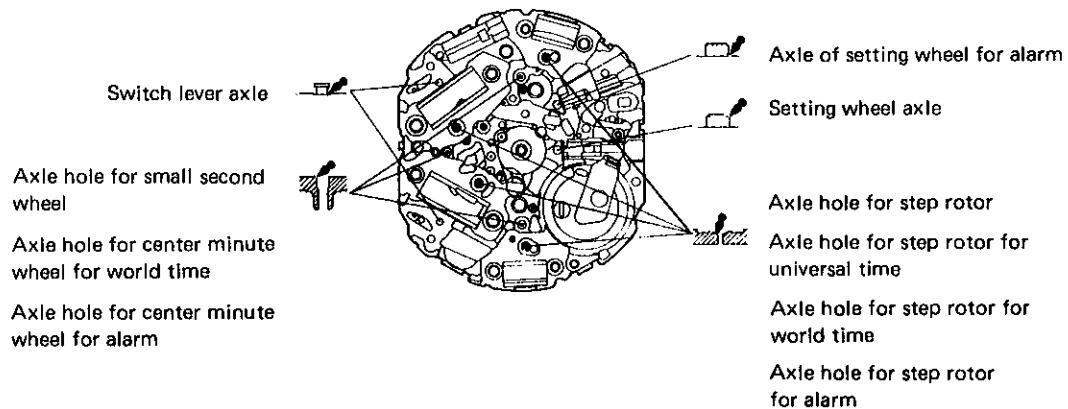

[Reassembling procedure]

- Reassemble the parts below in the following order.

- | | |
|--|--|
| 1) ⑥0 4146 700
Step rotor for world time (plastic: white) | 11) ⑤0 950 580
Intermediate wheel for world time (plastic: white) |
| 2) ⑤9 4146 700
Step rotor for alarm (plastic: white) | 12) ④9 281 580
Setting wheel (metal: silver) |
| 3) ⑤8 4146 700
Step rotor for universal time (plastic: white) | 13) ④8 261 580
Minute wheel (plastic: white) |
| 4) ⑤7 4146 700
Step rotor (plastic: white) | 14) ④7 885 581
Second intermediate wheel for universal time (plastic: green) |
| 5) ⑤6 281 582
Setting wheel for alarm (metal: silver) | 15) ④6 885 580
First intermediate wheel for universal time (plastic: white) |
| 6) ⑤5 261 582
Minute wheel for alarm (plastic: white) | 16) ④5 701 580
Fifth wheel and pinion (plastic: green) |
| 7) ⑤4 270 580
Center minute wheel for alarm (metal: gold) | 17) ④4 231 580
Third wheel and pinion (metal: gold) |
| 8) ⑤3 950 580
Intermediate wheel for alarm (plastic: white) | 18) ④3 241 583
Fourth wheel and pinion (metal: gold) |
| 9) ⑤2 264 580
Minute wheel for world time (plastic: white) | 19) ④2 240 580
Small second wheel (metal: gold) |
| 10) ⑤1 270 580
Center minute wheel for world time (metal: gold) | 20) ④1 888 580
888 582
Indicator wheel and pinion for universal time (metal: gold) |

* Intermediate wheel for alarm and intermediate wheel for world time are interchangeable.

* The numerals inscribed on the main plate and the plastic wheels and pinions denote the block No.

II. CHECKING OF THE FUNCTIONS

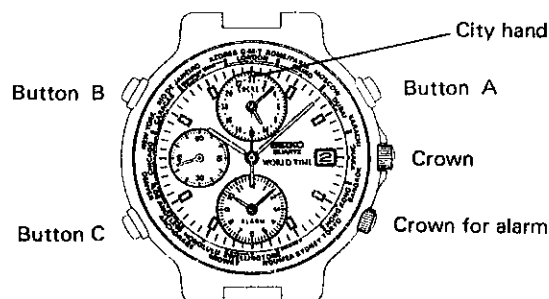

- Adjustment of the city hand

- 1) Pull out the crown at the 3 o'clock side all the way to the second click.
- 2) Press button "A" or "B" to adjust the city hand to the nearest city marker.

* The hand turns clockwise or counterclockwise by pressing button "A" or "B", respectively.

● Home time and world time setting

- 1) After adjusting the city hand, pull out the crown at the 3 o'clock side to the second click and turn it to set the main time to the current time of your local area.
* Check that AM/PM is properly set. If the date changes, the watch is set for the AM period.
- 2) Push the crown back in to the normal position.
- 3) Press button "A" or "B" to set the city hand to the current time of your local area.
* The hand turns clockwise or counterclockwise by pressing button "A" or "B", respectively.
- 4) Pull out the crown at the 3 o'clock side to the first click (calendar setting position) and press button "A" or "B" to set the small hands of the world time display (at the 12 o'clock position) to the main time.
* World time is displayed in the 24-hour indication.
- 5) Push the crown back in to the normal position. The hands of the world time display starts moving.
Note: The main time and the world time hands do not move correspondingly with each other.

● Checking of the world time function

- 1) Press button "A" or "B" with the crown at the 3 o'clock side at the normal position to set the city hand to a desired city and check if the small hands of the world time display at the 12 o'clock position turn to indicate the time of the corresponding city.
* Time differential between two cities marked side by side on the bezel is one hour.

● Checking of the regular alarm function

- 1) Pull out the crown for alarm all the way to the second click and check if the warning sound beeps for one second. The warning sound indicates that the designated alarm time has been canceled.
- 2) Push the crown for alarm in to the first click from the second click, and check if the chime rings for approximately one minute.
- 3) Pull out the crown for alarm all the way to the second click to check the time the alarm hands indicate, and then push it in to the first click. By doing so, the chime rings. Press button "C" to stop it.
- 4) Press button "C" again to advance the alarm hands one minute ahead of the time you have checked.
- 5) Check if the chime rings after one minute for 20 seconds and stops.
* The regular alarm is engaged when the crown for alarm is at the first click position. The crown at the 3 o'clock side has nothing to do with engagement/disengagement of the alarm.

● Checking of the single-time alarm function

- 1) Make sure that the crown for alarm is at the normal position.
- 2) Press button "C" to advance the alarm hands one minute ahead of the time that the alarm hands indicate.
- 3) Check if the beeping sound rings after one minute (at the current time) for 20 seconds and stops.
* After the alarm rings, the alarm hands start moving to indicate the current time.

III. VALUE CHECKING

● Coil block resistance

Coil block for alarm	:	1.8K Ω ~ 2.4K Ω
Coil block for world time	:	1.8K Ω ~ 2.4K Ω
Coil block for universal time	:	2.0K Ω ~ 2.6K Ω
Coil block	:	1.7K Ω ~ 2.3K Ω

● Upconverter coil resistance : 45 Ω ~ 60 Ω

● Current consumption

Before measuring current consumption, be sure to reset the circuit.

* Refer to "A necessary step after installing the battery" of "PARTS CATALOGUE/TECHNICAL GUIDE Cal. 7T32".

... For the whole of the movement

Main time mode : less than 2.5 μ A

Main time mode + world time mode + alarm mode : less than 9.5 μ A

For the circuit block alone

Main time mode : less than 1.8 μ A

● Time accuracy

When measuring the accuracy, make sure that the crown for main time setting (crown at the 3 o'clock side) and the crown for alarm (crown at the 4 o'clock side) are at the first click and the second click positions, respectively.

* Main time and world time setting is impossible when the crowns are at the above positions.