

SEIKO

QUARTZ

Cal. 7126A

PARTS LIST

Cal. 7126A

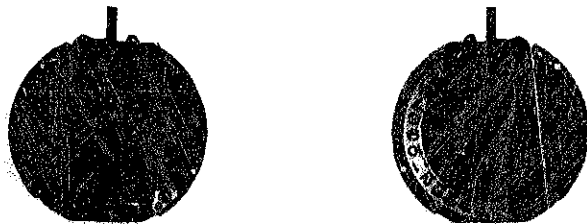

131 115



165 001



167 001



168 003



168 004



168 007



231 029



241 060



261 019



270 037



271 056



282 023



354 078



376 001



383 049



384 022



388 022



391 018



436 004



464 001



☆470 170



495 003



556 013



560 004



701 007



☆801 103



802 022



803 006



808 035



808 036



810 012



817 015



868 012

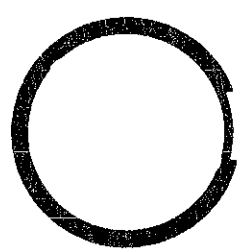

☆884 128



963 007



4002 010



4146 007



4219 012



4239 018



4242 075



4259 009



4270 024

011 542

☆Maxell SR1130SW

012 152	012 153	012 154	012 713	012 789	013 975	017 135	017 136	017 137	017 138
017 260	017 261	017 262	017 263	017 264	017 265	017 266	017 268	017 379	2/1

☆⇒ Please see remarks on the next reverse page.

Cal. 7126A

Characteristics

Casing diameter : 26.0 × 23.7mm
 Maximum height : 3.8 mm without battery
 Jewels : 2 j
 Frequency of quartz crystal oscillator : 32,768 Hz (Hz=Hertz Cycles per second)
 Driving system : Step motor (2 poles)
 Regulation system : Trimmer condenser
 Train wheel setting
 Calendar (Day and date)
 Time differential adjusting device : Pull the crown out to the first click and the hour hand move one hour every click.
 Instant setting device for day and date calendar.
 Battery life indicator : Second hand moves in two-second interval.

PART NO.	PART NAME	PART NO.	PART NAME
131 115	Third wheel bridge	4259 009	Anti-magnetic shield plate
165 001	Hour corrector lever	4270 024	Battery connection
167 001	Time corrector setting wheel	011 542	Upper hole jewel for step rotor
168 003	Intermediate wheel for time correction (C)	011 542	Lower hole jewel for step rotor
168 004	Intermediate wheel for hour correction (D)	012 152	Third wheel bridge screw
168 007	Intermediate wheel for time correction (G)	012 152	Circuit block screw
231 029	Third wheel & pinion	012 152	Coil block screw
241 060	Fourth wheel & pinion	012 153	Day finger screw
261 019	Minute wheel	012 154	Screw for rocking bar holder
270 037	Center minute wheel with cannon pinion	012 154	Lower end piece screw for third wheel
271 056	Hour wheel	012 713	Hour wheel guard screw
282 023	Clutch wheel	012 789	Setting lever spring screw
354 078	Winding stem	013 975	Eccentric dial pin
376 001	Hour wheel guard	017 135	Tube for coil block (A)
383 049	Setting lever	017 136	Tube for coil block (B)
384 022	Yoke (Clutch lever)	017 137	Tube for circuit block
388 022	Setting lever spring	017 138	Tube for yoke
391 018	Train wheel setting lever	017 260	Tube for third wheel bridge (B)
436 004	Lower end-piece for third wheel	017 261	Tube for setting lever spring
464 001	Rocking bar holder	017 262	Tube for hour wheel guard (A)
☆470 170	Day star with dial click	017 263	Tube for hour wheel guard (B)
495 003	Spacer for third wheel bridge	017 264	Tube for hour wheel guard (C)
556 013	Date finger	017 265	Tube for third wheel bridge (A)
560 004	Friction spring for fourth wheel & pinion	017 266	Tube for third wheel bridge (C)
701 007	Fifth wheel & pinion	017 268	Tube for rocking bar holder
☆801 103	Date dial	017 379	Tube for date jumper screw
☆801 104		☆Maxell SR1130SW	Silver oxide battery
802 022	☆SEIKO SR1130SW		
803 006	☆SEIKO SB-AU		
808 035	Date dial guard (A)		
808 036	Date dial guard (B)		
810 012	Date jumper		
817 015	Intermediate date wheel		
868 012	Day finger		
☆884 128	Holding ring for dial		
963 007	Snap for day star with dial disk		
4001 173	Circuit block		
4002 010	Coil block		
4146 007	Step rotor		
4219 012	Insulator for battery connection		
4239 018	Rotor stator		
4242 075	Plus terminal of battery connection		

☆⇒Please see remarks on the reverse page.
 Part numbers in light letters are not shown in photos.

Cal. 7126A

Remarks :

Day star with dial disk

☆470 170..... Used when both the crown and the calendar frame are located at 3 o'clock position. If any other type of day star with dial disk is required, specify the number printed on the disk.

Date dial

☆801 103(Black figures on white background) } Used when both the crown and the calendar frame
☆801 104(White figures on black background) } are located at 3 o'clock position.

If any other type of date dial is required, specify ① Cal. No. ② Jewels ③ The crown position ④ The calendar frame position and ⑤ Dial No.

Holding ring for dial

☆884 128.....The type of holding ring for dial is determined based on design of cases and dials. If the shape of holding ring for dial is different from the photograph, check the case number and refer to "SEIKO Quartz Casing Parts List" to choose a corresponding holding ring for dial.

Battery

☆Maxell SR1130SW } The substitutive battery might be added to the applied battery in the future. In that
☆SEIKO SR1130SW } case, please refer to separate "BATTERY LIST FOR SEIKO QUARTZ
☆SEIKO SB-AU } WATCHES".

Note that SEIKO battery is marked with "SEIZAIKEN" on its (+) side.

TECHNICAL GUIDE

SEIKO
QUARTZ

CAL. 7126A

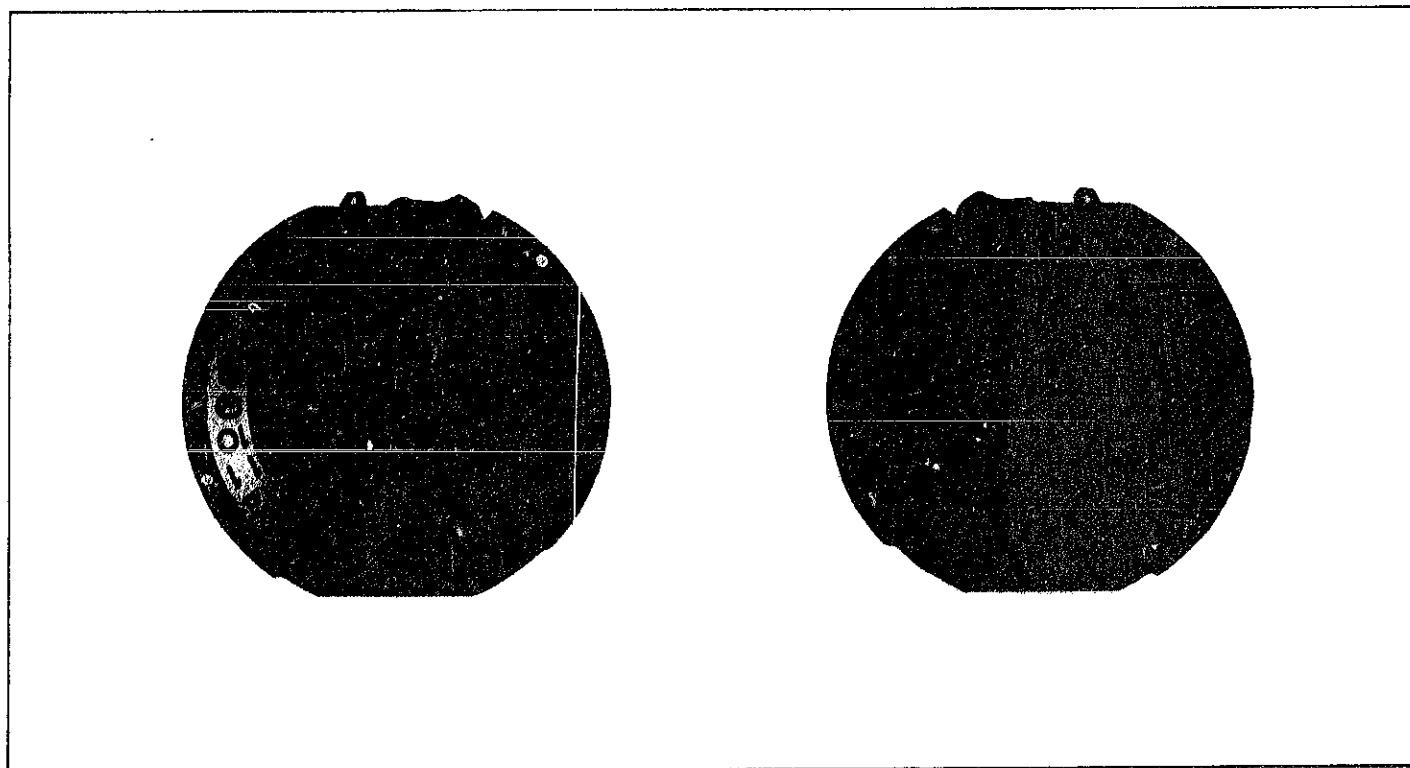

CONTENTS

I. SPECIFICATIONS	1
II. STRUCTURE OF THE CIRCUIT BLOCK	1
III. TIME DIFFERENTIAL ADJUSTING DEVICE	2
IV. DISASSEMBLING, REASSEMBLING AND LUBRICATING	3
1. Indicating mechanism	3
2. Electronic circuit	5
3. Gear train and setting mechanism	6
V. CHECKING AND ADJUSTMENT	7
• Check output signal	7
• Check battery voltage	7
• Check battery conductivity	7
• Check circuit block conductivity	7
• Check coil block	7
• Check reset and train wheel setting conditions	7
• Check accuracy	8
• Check current consumption	8

I. SPECIFICATIONS

Cal. No.	7126A
Item	
Time indication	3 hands
Additional mechanism	Day and date Time differential adjusting device Train wheel setting device Electronic circuit reset switch Battery life indicator
Loss/gain	Loss/gain at normal temperature range Monthly rate: less than 15 seconds (Annual rate: less than 3 minutes)
Casing diameter	φ26.0 mm
Height	3.8 mm without battery
Regulation system	Trimmer condenser
Measuring gate by Quartz Tester	Any gate is available.
Battery	Maxell SR1130SW or SEIKO (SEIZAIKEN) SR1130SW or SB-AU Battery life is approximately 5 years. Voltage 1.55V
Jewels	2 jewels

II. STRUCTURE OF THE CIRCUIT BLOCK

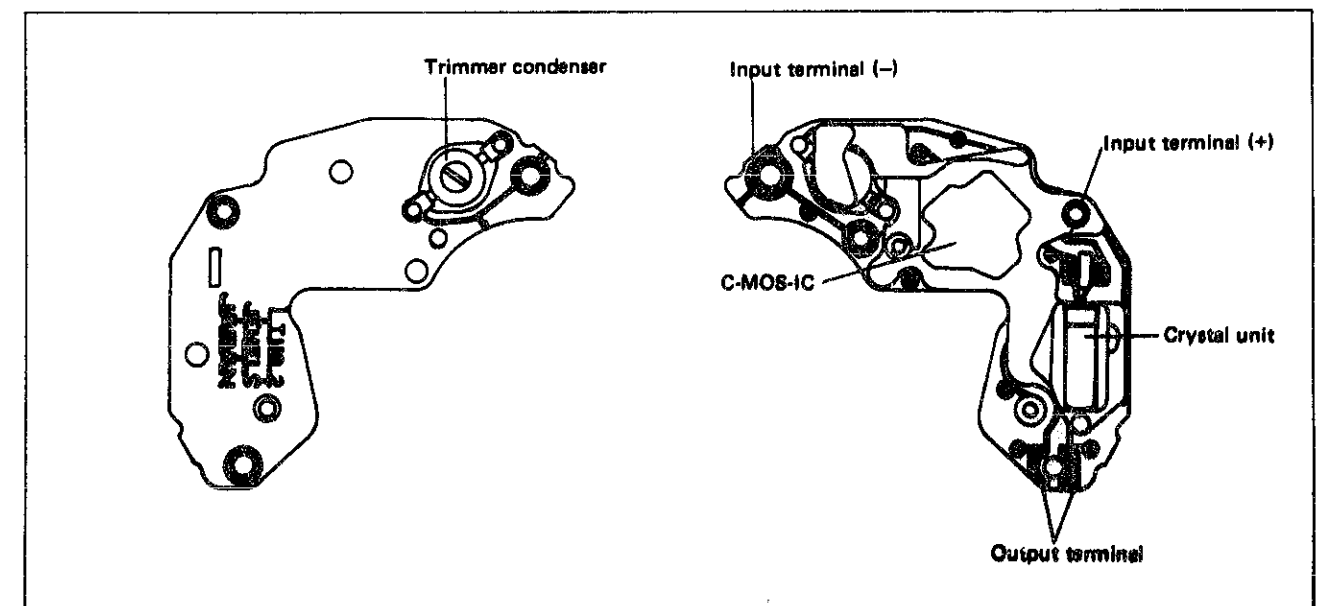

III. TIME DIFFERENTIAL ADJUSTING DEVICE

Cal. 7126A is provided with the time differential adjusting device which can advance or delay the time by an hour by turning the crown without stop moving.

In this device, as shown in the illustration below, the hour corrector lever moves when the crown is pulled out to the first click and the intermediate wheel for time correction C gears with the intermediate wheel for time correction G. Since the intermediate wheel for time correction G engages with the hour wheel, the hour hand can be advanced or delayed by an hour by turning the crown one click clockwise or counterclockwise.

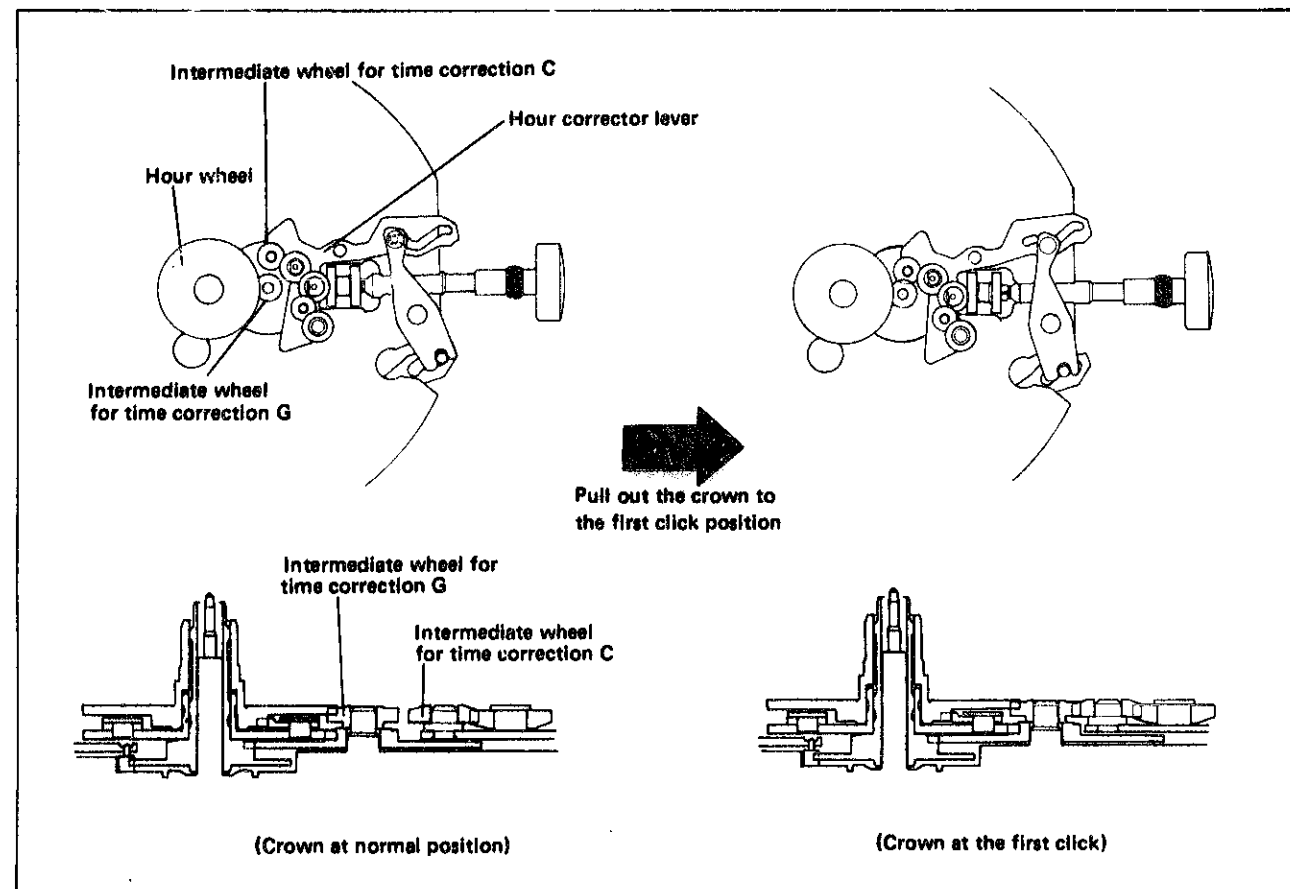

• The relation between hour wheel and time corrector setting wheel

Hour wheel and time corrector setting wheel normally move together. When adjusting time difference, time corrector setting wheel revolves by one cog (one hour) by intermediate wheel for time correction and after revolving, hour wheel is regulated by hour jumper.

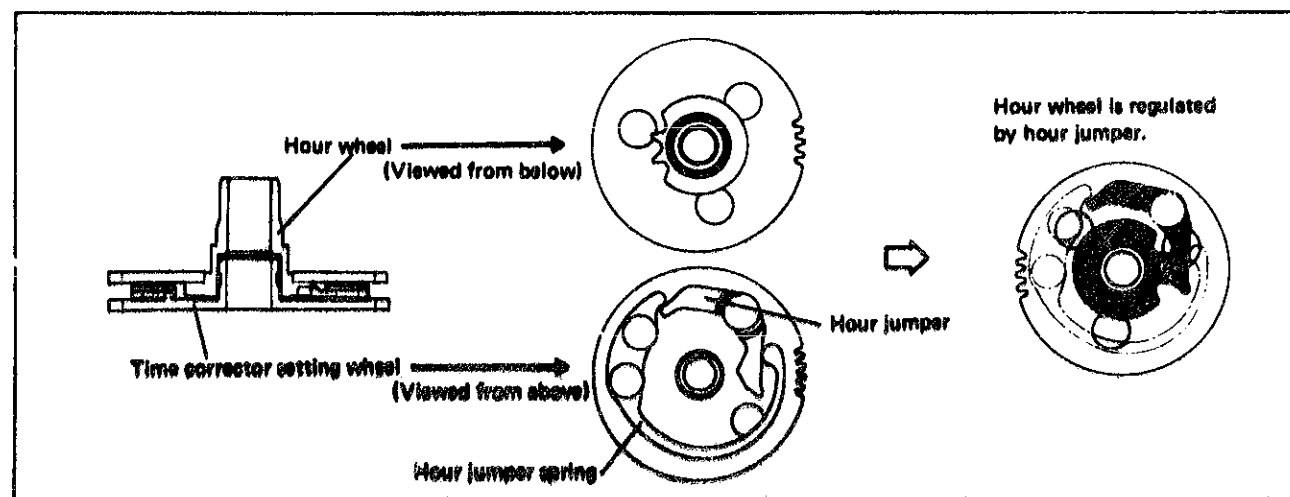

IV. DISASSEMBLING, REASSEMBLING AND LUBRICATING

Disassembling procedures Figs. ① - ⑤①
 Reassembling procedures Figs. ⑤① - ①

Lubricating: Type of oil

● Moebius A
 ○ SEIKO Watch Oil S-6

Oil quantity

○ Liberal
 ○ Normal quantity
 ○ Small quantity

1. Indicating mechanism

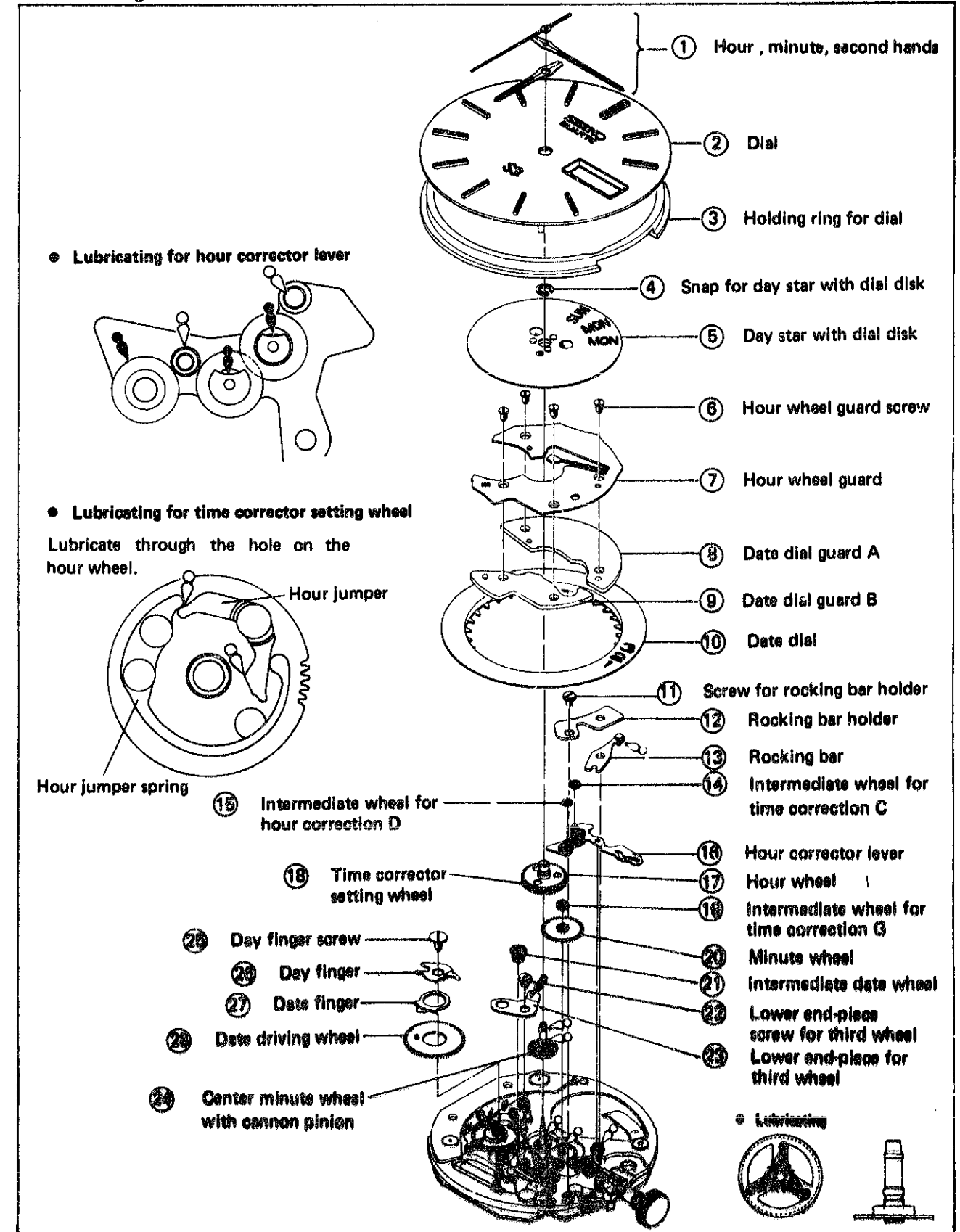

Remarks for disassembling and reassembling

① Hour, minute, second hands

After reassembling the hands, pull out the crown to the first click and check to see if the hour hand moves by an hour when adjusting time difference. At this time, be sure to check if the hands go around without touching the "SEIKO" mark and "SQ" mark.

⑬ Rocking bar

Set the rocking bar as shown in the illustration on the right, the notch to the protrusion of the setting lever and the pin on the tip of rocking bar to the groove of the hour corrector lever respectively.

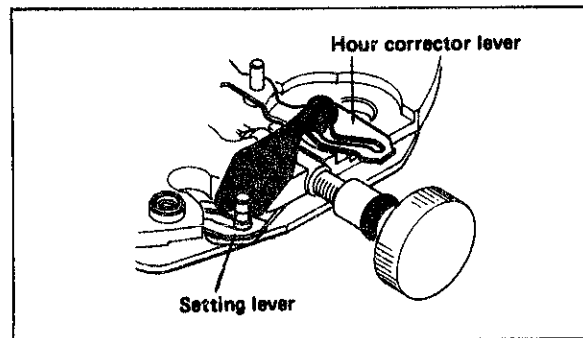

⑭ ⑮ ⑯ Intermediate wheel for time correction C, G, and intermediate wheel for hour correction D

When reassembling them, set them with their beveled side up on the hour corrector lever.

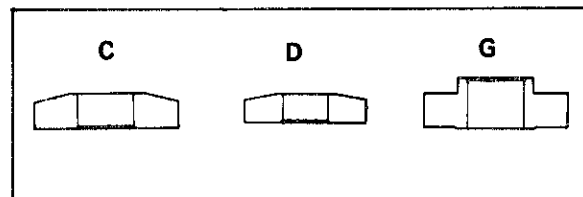

⑰ ⑱ Hour wheel and time corrector setting wheel

When normal disassembling and reassembling, be sure to handle them together. If disassembling and reassembling are needed, follow the procedures below.

● How to disassemble

Put the checking stick in the clearance between the hour wheel and the time corrector setting wheel and widen the clearance little by little. After that, put the checking stick in the holes (three places) on the hour wheel and push the time corrector setting wheel to remove it from the hour wheel.

● How to reassemble

After putting the hour wheel on the time corrector setting wheel, put the checking stick in the holes on the hour wheel and putting out the hour jumper to engage it with the hour wheel.

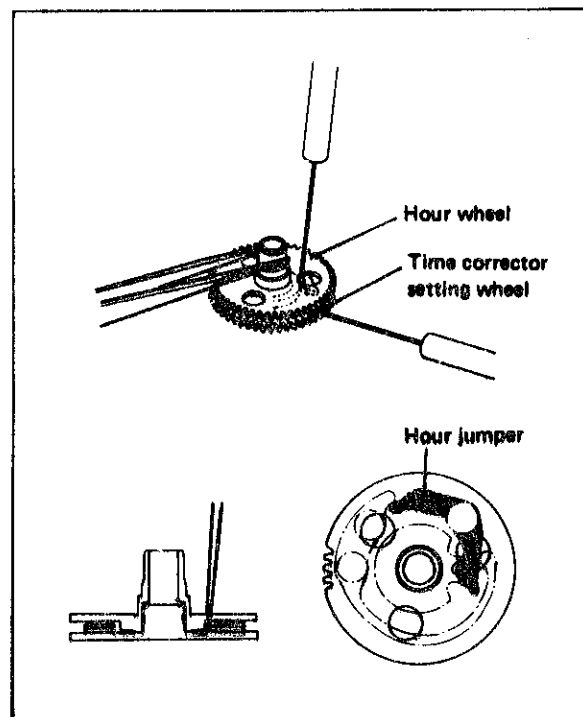

2. Electronic circuit

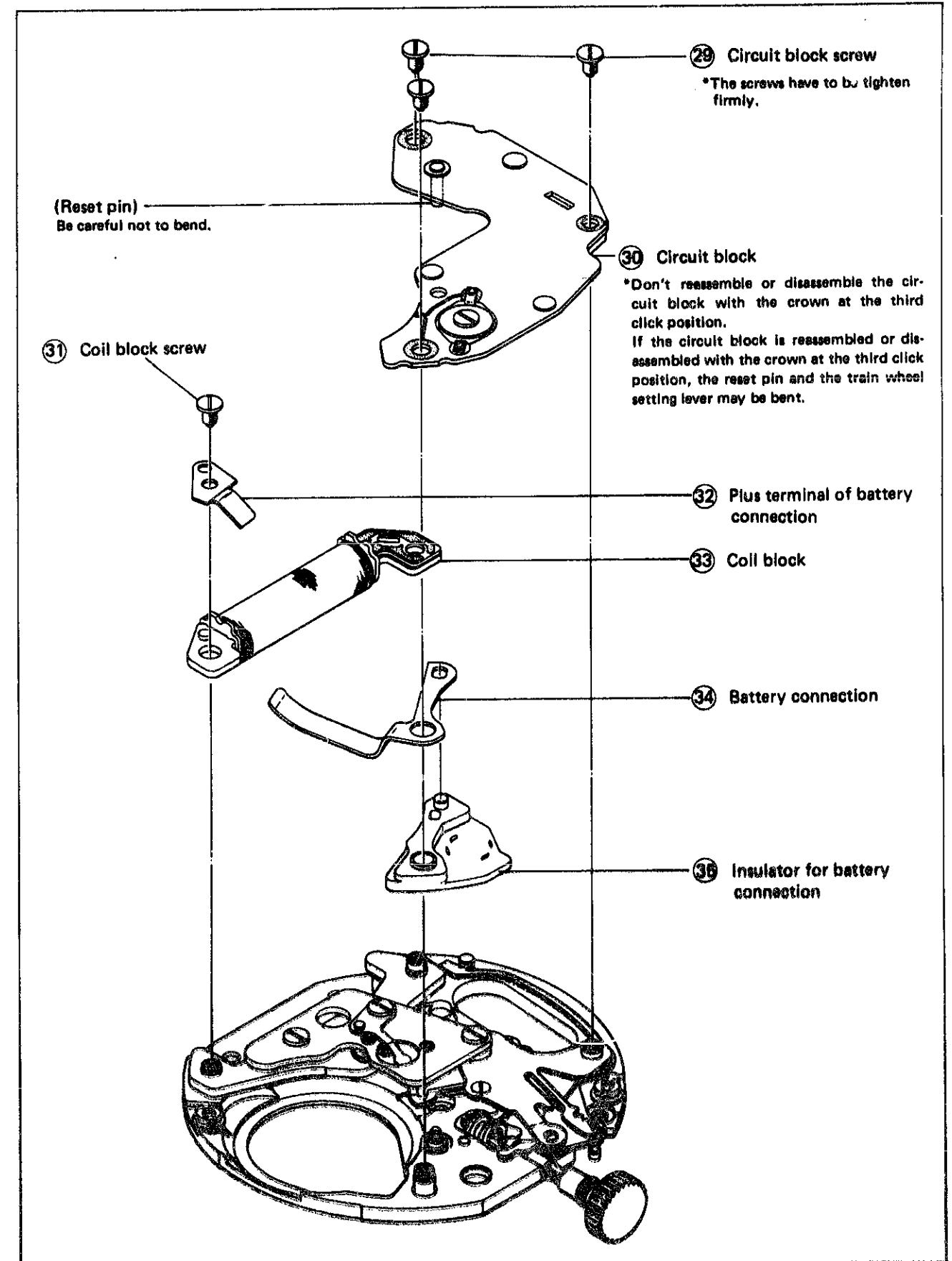

3. Gear train and setting mechanism

- Lubricate the tip of the fourth wheel and pinion
Friction spring for fourth wheel and pinion

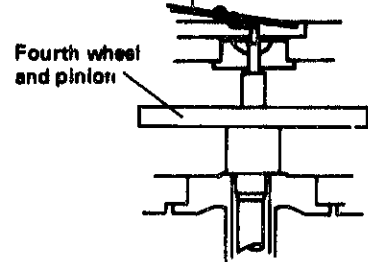



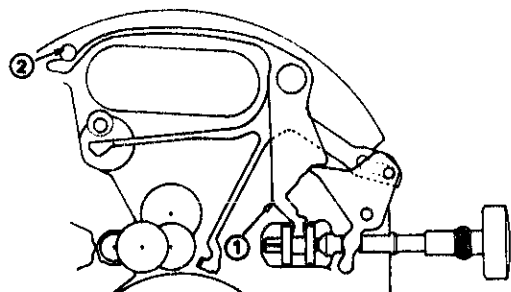

- How to reassemble the yoke (Clutch lever)

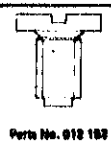

With the crown at the normal position, hold the arrow marked portion ① of yoke (clutch lever) by your fingers and hold the spring portion by the tweezers, and set it inside the arrow marked pin ②.

- List of screws used

 Parts No. 010 152	Circuit block screw (3 pcs.) Coil block screw (1 pc.) Third wheel bridge screw (3 pcs.)	7 pcs.
 Parts No. 010 153	Day finger screw	1 pc.
 Parts No. 010 154	Lower end-piece screw for third wheel (1 pc.) Screw for rocking bar holder (1 pc.)	2 pcs.
 Parts No. 010 200	Setting lever spring screw	1 pc.
 Parts No. 010 212	Hour wheel guard screw	4 pcs.

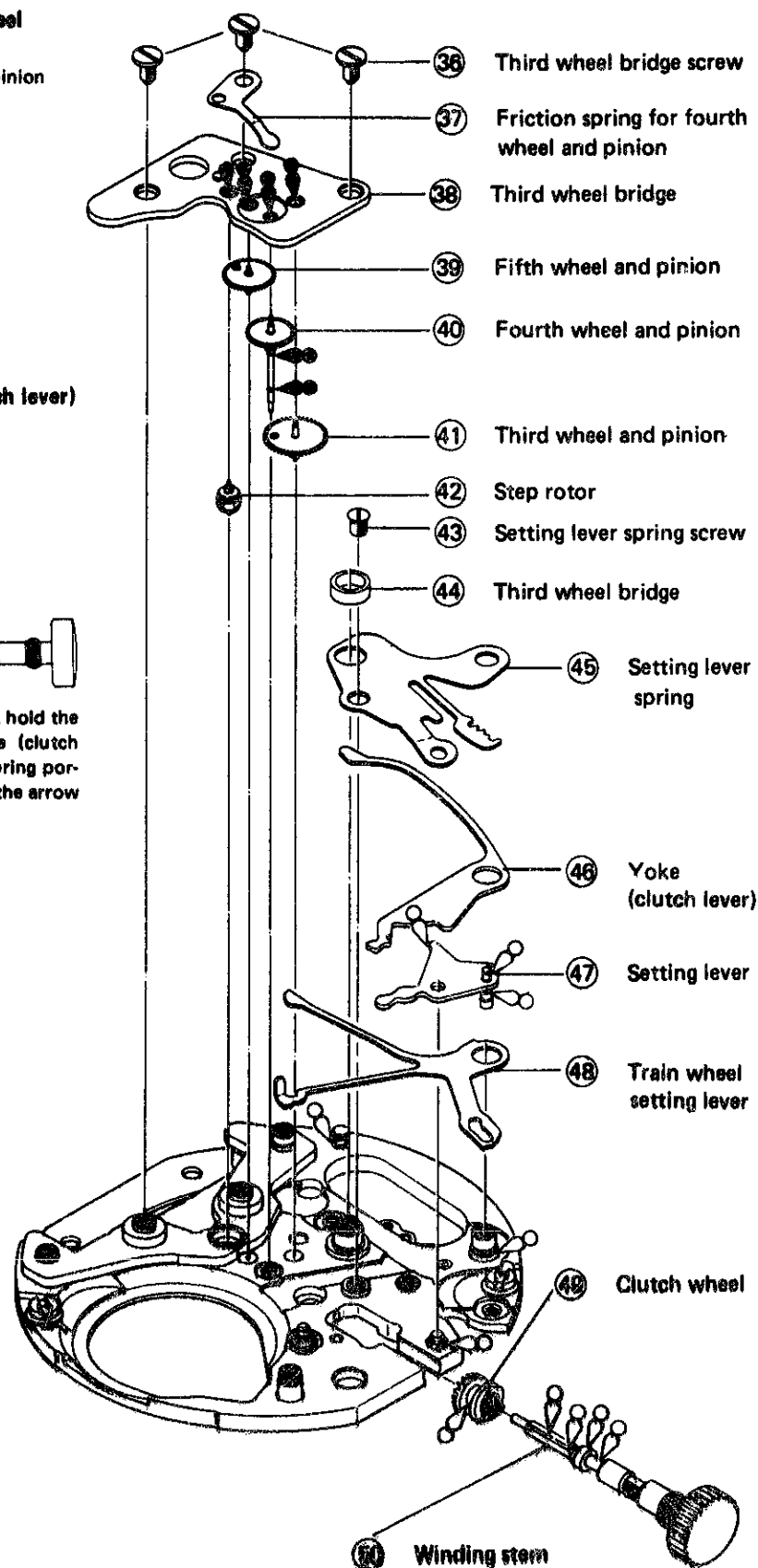

V. CHECKING AND ADJUSTMENT

- Refer to the "SEIKO QUARTZ TECHNICAL GUIDE, GENERAL INSTRUCTION" for analogue watches for details.

Procedures	
CHECK OUTPUT SIGNAL	Result: One-second blinking : Normal No one-second blinking : Defective
CHECK BATTERY VOLTAGE	Result: More than 1.5V : Normal Less than 1.5V : Defective
CHECK BATTERY CONDUCTIVITY	
CHECK CIRCUIT BLOCK CONDUCTIVITY	
CHECK COIL BLOCK	Result: 2.0KΩ ~ 4.0KΩ : Normal Less than 2.0KΩ (Short circuit) : Defective More than 4.0KΩ (Broken wire) : Defective Replace the coil block with a new one.
CHECK RESET AND TRAIN WHEEL SETTING CONDITIONS	Result: Stops completely and starts moving after one second: Normal Does not stop or move irregularly: Defective

1. Check to see if the second hand stops immediately when the crown is pulled out to the third click and if it starts promptly after one second when the crown is pushed back to the normal position.

2. Check for the clearance between the reset portion of the train wheel setting lever and the reset pin. (Check after the circuit block is removed.)

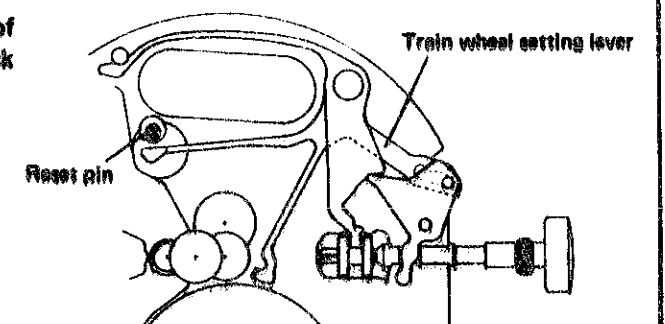

Procedures

① With the crown at the normal, first, and the second click position

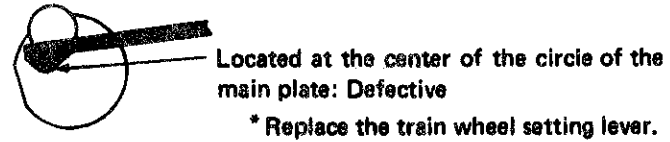
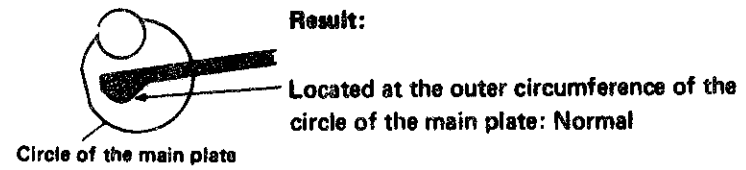

② With the crown at the third click position

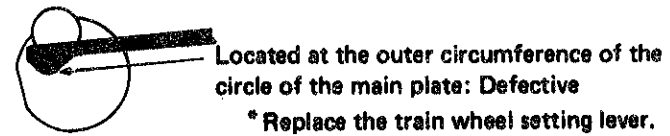
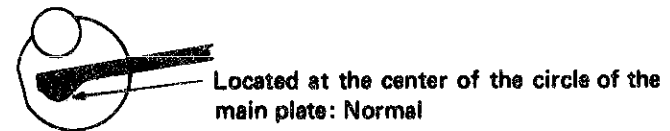

3. Check to see if there is a clearance between the reset portion of train wheel setting lever and the fourth wheel and pinion.

① With the crown at the normal position, the first click and the second click position.

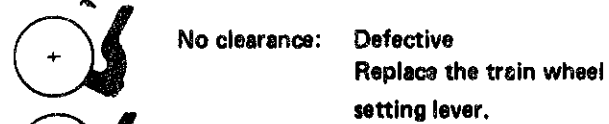

② With the crown at the third click position

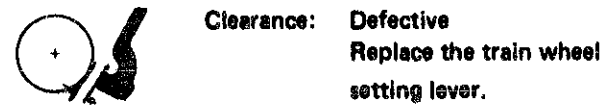

CHECK ACCURACY

CHECK CURRENT CONSUMPTION

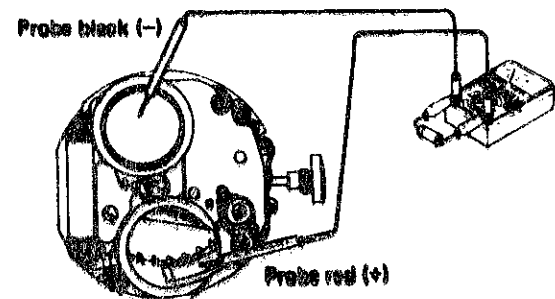

Result:
Less than 2.0mA : Normal
More than 2.0mA : Defective
Check the electronic circuit.

All procedures of Disassembling, reassembling, Checking and Adjustment are completed.