

SEIKO

QUARTZ

Cal. 7A28A

**PARTS
CATALOGUE**

Cal. 7A28A



125 725 190 725 190 726 190 727 221 725 231 725 240 725 241 725 261 725 271 725

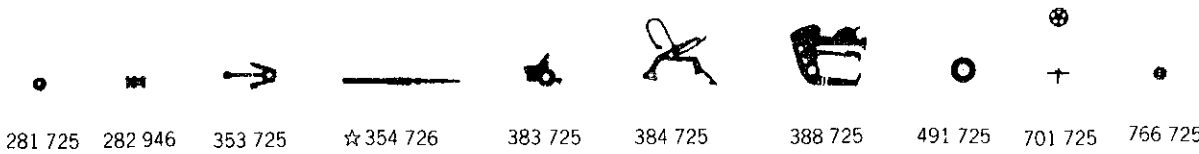

281 725 282 946 353 725 ☆354 726 383 725 384 725 388 725 491 725 701 725 766 725

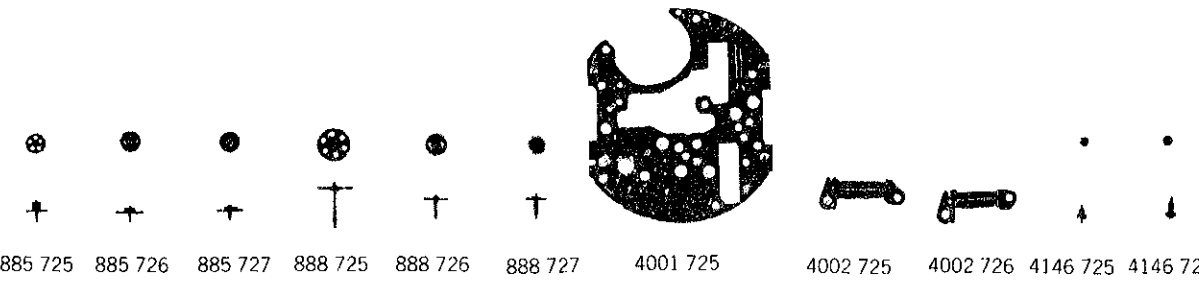

885 725 885 726 885 727 888 725 888 726 888 727 4001 725 4002 725 4002 726 4146 725 4146 727

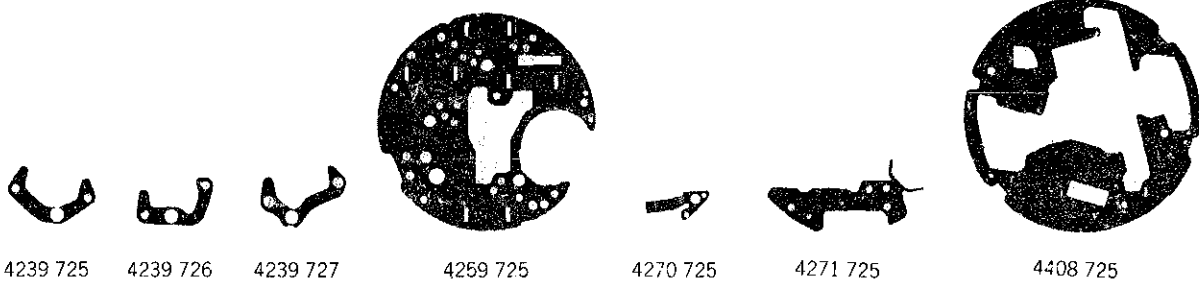

4239 725 4239 726 4239 727 4269 725 4270 725 4271 725 4408 725

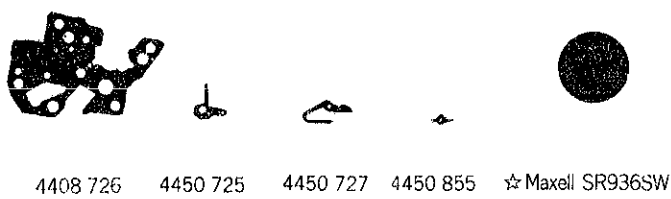

4408 726 4450 725 4450 727 4450 855 ☆Maxell SR936SW

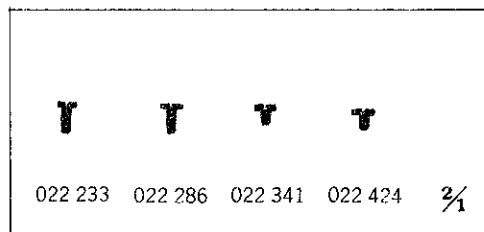

022 233 022 286 022 341 022 424 3/4

Cal. 7A28A

Characteristics

Casing diameter : ϕ 29.0 mm
 Maximum height : 3.5 mm without battery
 Jewels : 15 j
 Frequency of quartz crystal oscillator : 32,768 Hz (Hz = Cycles per second)
 Driving system : Step motor. (2 poles)
 Regulating system : Rotary step switch
 Train wheel setting
 Chronograph
 Battery life indicator

PART NO.	PART NAME	PART NO.	PART NAME
125 725	Train wheel bridge	4271 725	Battery connection (+)
190 725	Chronograph second bridge	4408 725	Circuit block spacer
190 726	Chronograph minute bridge	4408 726	Setting wheel spacer
190 727	Chronograph 5/100 second bridge	4450 725	Change-over switch lever
221 725	Center wheel & pinion	4450 727	Switch lever
231 725	Third wheel & pinion	4450 855	Rotary step switch
240 725	Small second wheel	011 151	Lower hole jewel for 5/100 second counting wheel
241 725	Fourth wheel & pinion	011 306	Upper hole jewel for minute counting wheel
261 725	Minute wheel	011 306	Upper hole jewel for 5/100 second counting wheel
271 725	Hour wheel	011 542	Upper hole jewel for fifth wheel
281 725	Setting wheel	011 542	Upper hole jewel for 5/100 second-counting intermediate wheel
282 946	Clutch wheel	011 542	Lower hole jewel for 5/100 second-counting intermediate wheel
353 725	Friction spring for second counting wheel	011 552	Lower hole jewel for step rotor
☆354 726	Winding stem	011 552	Lower hole jewel for step rotor (Chronograph minute)
383 725	Setting lever	011 552	Lower hole jewel for step rotor (Chronograph second)
384 725	Yoke	011 552	Lower hole jewel for step rotor (Chronograph 5/100 second)
388 725	Setting lever spring	011 568	Upper hole jewel for rotor stator
491 725	Dial washer	011 568	Upper hole jewel for rotor stator (Chronograph minute)
701 725	Fifth wheel & pinion	011 568	Upper hole jewel for rotor stator (Chronograph second)
766 725	Intermediate minute wheel	011 568	Upper hole jewel for rotor stator (Chronograph 5/100 second)
885 725	Second-counting intermediate wheel	011 739	Upper hole jewel for center minute wheel
885 726	Minute-counting intermediate wheel	022 233	Dial screw
885 727	5/100 second-counting intermediate wheel	022 286	Anti-magnetic shield plate screw
888 725	Second counting wheel	022 286	Battery connection (+) screw
888 726	Minute counting wheel	022 341	Chronograph second bridge screw
888 727	5/100 second counting wheel	022 424	Train wheel bridge screw
4001 725	Circuit block	022 424	Chronograph minute bridge screw
4002 725	Coil block A (for time indication)	022 424	Chronograph 5/100 second bridge screw
4002 725	Coil block B (for chronograph second)	022 424	Coil block screw
4002 726	Coil block C (for chronograph minute)	022 424	Setting lever spring screw
4002 726	Coil block D (for chronograph 5/100 second)	023 337	Tube for setting lever spring screw
4146 725	Step rotor A (for time)	023 351	Guide tube for setting lever spring screw
4146 725	Step rotor C (for minute)	027 138	Tube for train wheel bridge
4146 725	Step rotor D (for 5/100 second)		
4146 727	Step rotor B (for second)		
4239 725	Rotor stator A (for time)		
4239 726	Rotor stator C (for chronograph minute)		
4239 726	Rotor stator D (for chronograph 5/100 second)		
4239 727	Rotor stator B (for chronograph second)		
4259 725	Anti-magnetic shield plate		
4270 725	Battery connection (--)		

☆ ⇨ Please see remarks on the reverse page.
 Part numbers in light letters are not shown in photos.

Cal. 7A28A

PART NO.	PART NAME	PART NO.	PART NAME
027 138	Tube for chronograph minute bridge	027 146	Tube for chronograph second bridge
027 138	Tube for chronograph 5/100 second bridge	027 758	Setting lever pin
027 139	Tube for yoke screw	027 759	Switch lever axle
027 140	Tube for coil block screw	027 760	Switch lever pin
☆027 141	Tube for anti-magnetic shield plate screw (A)	027 761	Switch pin
027 141	Tube for battery connection (+) screw (A)	☆Maxell SR936SW	Silver oxide battery
☆027 143	Tube for anti-magnetic shield plate screw (B)		
027 143	Tube for battery connection (+) screw (B)		
☆027 144	Tube for anti-magnetic shield plate screw (C)		

Remarks :

Winding stem

☆354 726.....Refer to the photograph on the front page.
 If the combination of the winding stem and case is unknown, check the case number and refer to "SEIKO Quartz Casing Parts Catalogue" to choose a corresponding stem.

Tube for anti-magnetic shield plate (A), (B), (C)

☆027 141 }
 ☆027 143 }Refer to the illustration on the right.
 ☆027 144 }

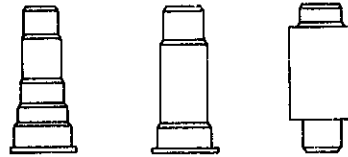

☆027 141 ☆027 143 ☆027 144

Battery

☆Maxell SR936SW.....The substitutive battery might be added to the applied battery in the future. In that case, please refer to separate "BATTERY LIST FOR SEIKO QUARTZ WATCHES."

TECHNICAL GUIDE

SEIKO
QUARTZ

CAL. 7A28A



CONTENTS

I. SPECIFICATIONS	1
II. STRUCTURE OF CIRCUIT BLOCK	1
III. DESIGNATION AND OPERATION	2
IV. DISASSEMBLING, REASSEMBLING AND LUBRICATING	3
1. Disassembling, reassembling and lubricating of the case	3
2. Disassembling, reassembling and lubricating of the movement	4
V. CHECKING AND ADJUSTMENT	9
• Check output signal	9
• Check hand condition	9
• Check battery voltage	9
• Check battery conductivity	9
• Check circuit block conductivity	9
• Check coil block	9
• Check reset and train wheel setting condition	10
• Check gear train mechanism	10
• Check accuracy	11
• Check current consumption	11
• Check water resistance	11
• Check conductivity of switch components	11
• Check battery life indicator	11
• Check appearance and functioning	11

I. SPECIFICATIONS

Item	Cal. No.	7A28A
Time indication	Hour, minute and small second hands	
Stopwatch function	Minute, second and 5/100 second	
Additional mechanism	<ul style="list-style-type: none"> • Counter function • Electronic circuit reset switch • Train wheel setting device • Battery life indicator 	
Loss/gain	Monthly rate at normal temperature range: less than 15 seconds	
Movement size	Outside diameter	φ31.1 mm
	Casing diameter	φ29.0 mm
	Height	3.5 mm without battery
Regulation system	Rotary step switch	
Measuring gate by quartz tester	Use the 10-second gate.	
Battery	U.C.C. 394, Maxell SR936SW Battery life is approximately 2 years. Voltage: 1.55V	
Jewels	15 jewels	

II. STRUCTURE OF CIRCUIT BLOCK

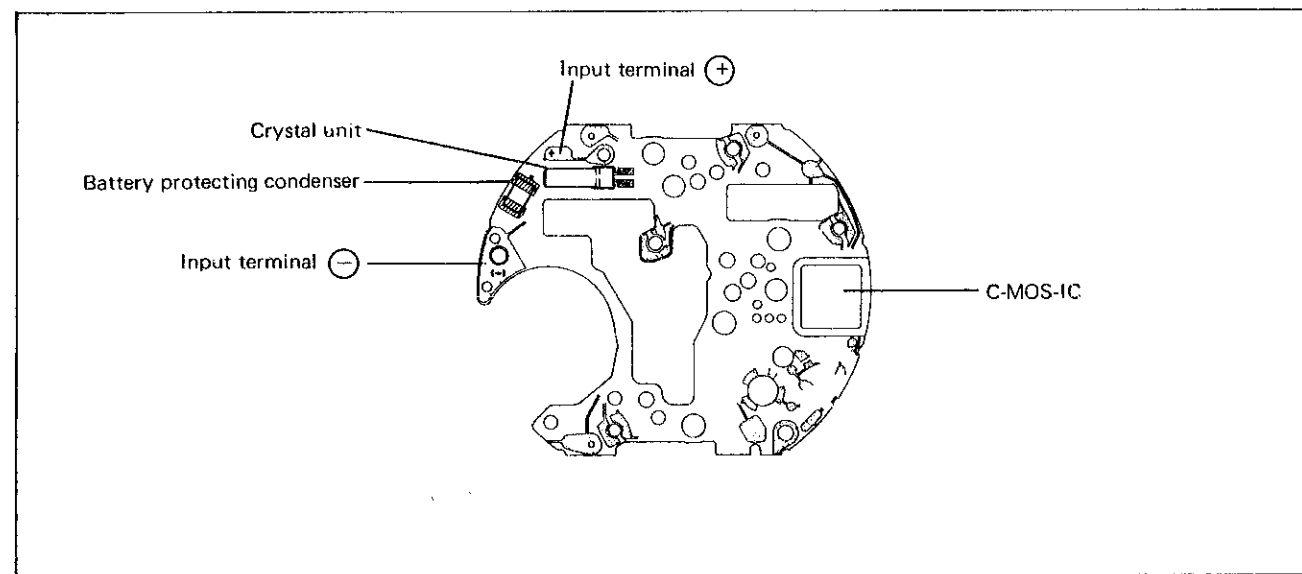

III. DESIGNATION AND OPERATION

1. Names of the parts and their functions

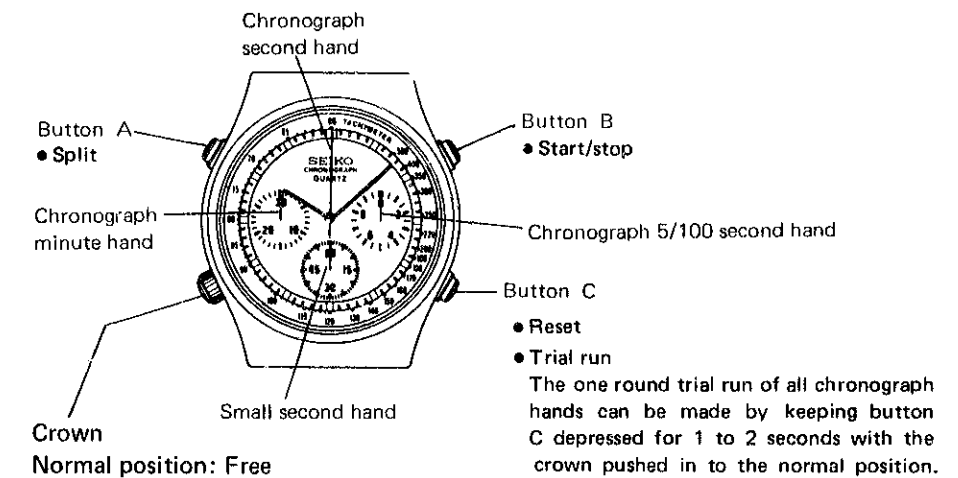

1st click: Counter

The chronograph hands can be used as counter scales by each depression of button A, B or C.

To reset the hands, depress respective buttons until the hands reach their reset position.

2nd click: Time setting

By turning the crown clockwise or counterclockwise, the hour and minute hands can be turned back or advanced respectively.

When the chronograph hands are not reset, follow the chart below.

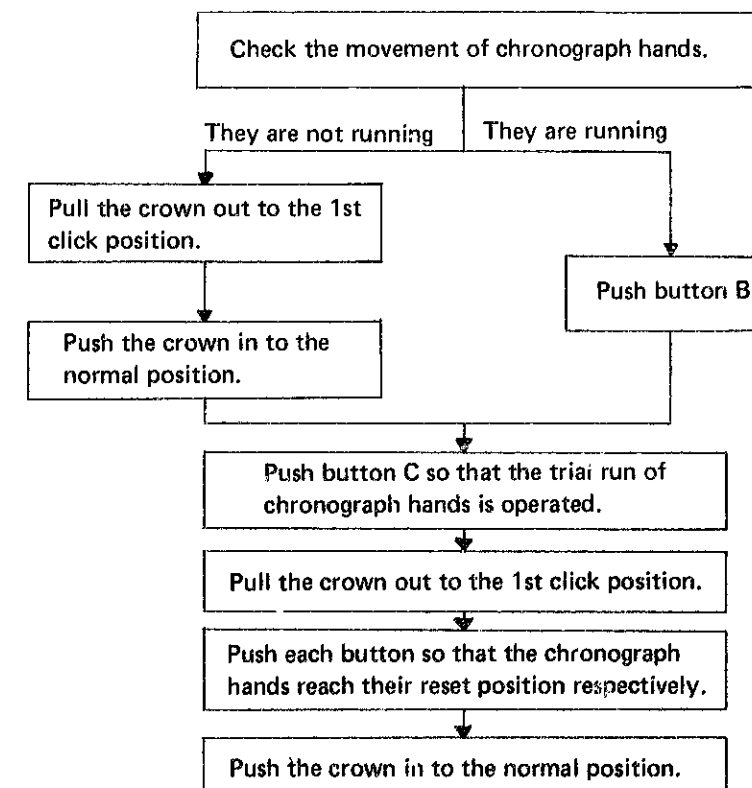

IV. DISASSEMBLING, REASSEMBLING AND LUBRICATING

1. Disassembling, reassembling and lubricating of the case

- Disassembling procedures Figs. : ① → ⑤
- Reassembling procedures Figs. : ⑤ → ①

Types of oil

- Silicone grease 500,000 c.s.
- Moebius A
- SEIKO watch oil S-6

• How to remove the bezel and dial ring (for the watches of case No. 7A28-702 and 7A28-703, with case construction mark A4, and watches with the case construction marks A5 and A6.)
When the bezel gasket or dial ring needs to be replaced, pry the bezel up at the opening notch with the case opener and remove the bezel and dial ring. If the inside of the dial ring is pushed with the disk, the dial ring may be deformed or damaged. Be sure not to push the dial ring from inside.

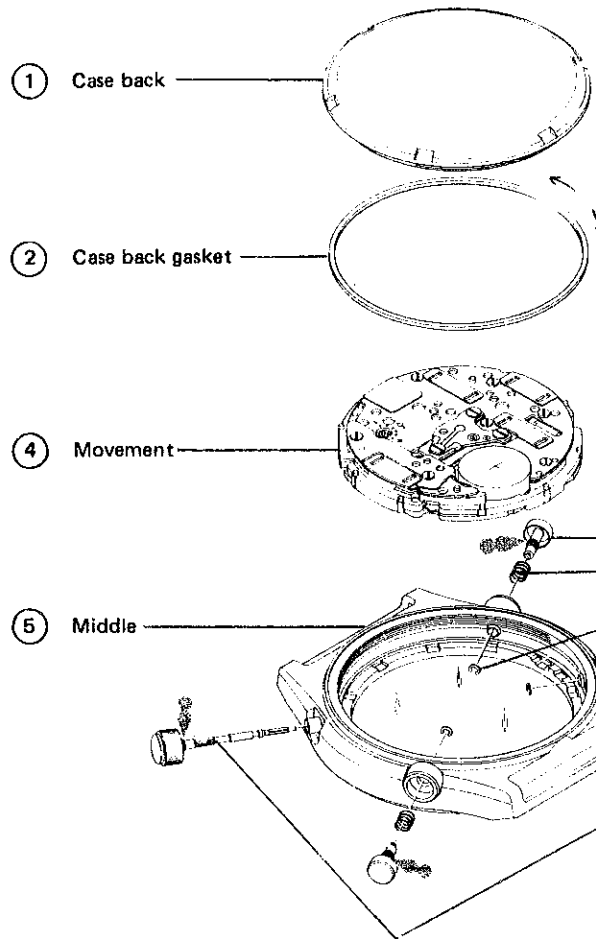

(Button)
(Button spring)
(Button spring clip)
It is not necessary to disassemble them in the normal disassembling and reassembling procedures.

Remarks on disassembling
Pull the crown to the second click, and remove the stem with crown by pushing the setting lever through the arrow marked hole.

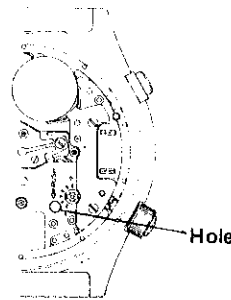

• How to replace the button and button holder for case No. 7A28-7000

<Disassembling>

1. Loosen the screws with a screwdriver with care not to damage the case and remove the button holder.
2. Remove the button spring clip for the button to be replaced and push the button out.

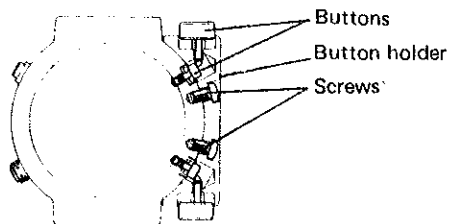

<Reassembling>

1. Lubricate the buttons before they are set.
2. Put a small quantity of rubberized adhesive to the screw hole of the case.
3. Set the buttons in to the case or the button holder, and fix them with the button spring clip.
4. Finally set the button holder and fasten the screws.

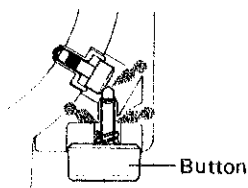

2. Disassembling, reassembling and lubricating of the movement

• List of screws used

Shape	Part No.	Part Names	Shape	Part No.	Part Names
		Train wheel bridge screw (2 pcs.)		022 341	Chronograph second bridge screw (3 pcs.)
		Chronograph minute bridge screw (1 pc.)		022 286	Antimagnetic shield plate screw (5 pcs.)
	022 424	Chronograph 5/100 second bridge screw (1 pc.)			Battery connection (+) screw (2 pcs.)
		Coil block screw (4 pcs.)		022 233	Dial screw (2 pcs.)
		Setting lever spring screw (1 pc.)			

- Disassembling procedures Figs.: ① → ⑥③
- Reassembling procedures Figs. : ⑥③ → ①

• Use the universal movement holder for disassembling and reassembling.

(1) Disassembling, reassembling and lubricating of the chronograph second hand ~ Hour wheel

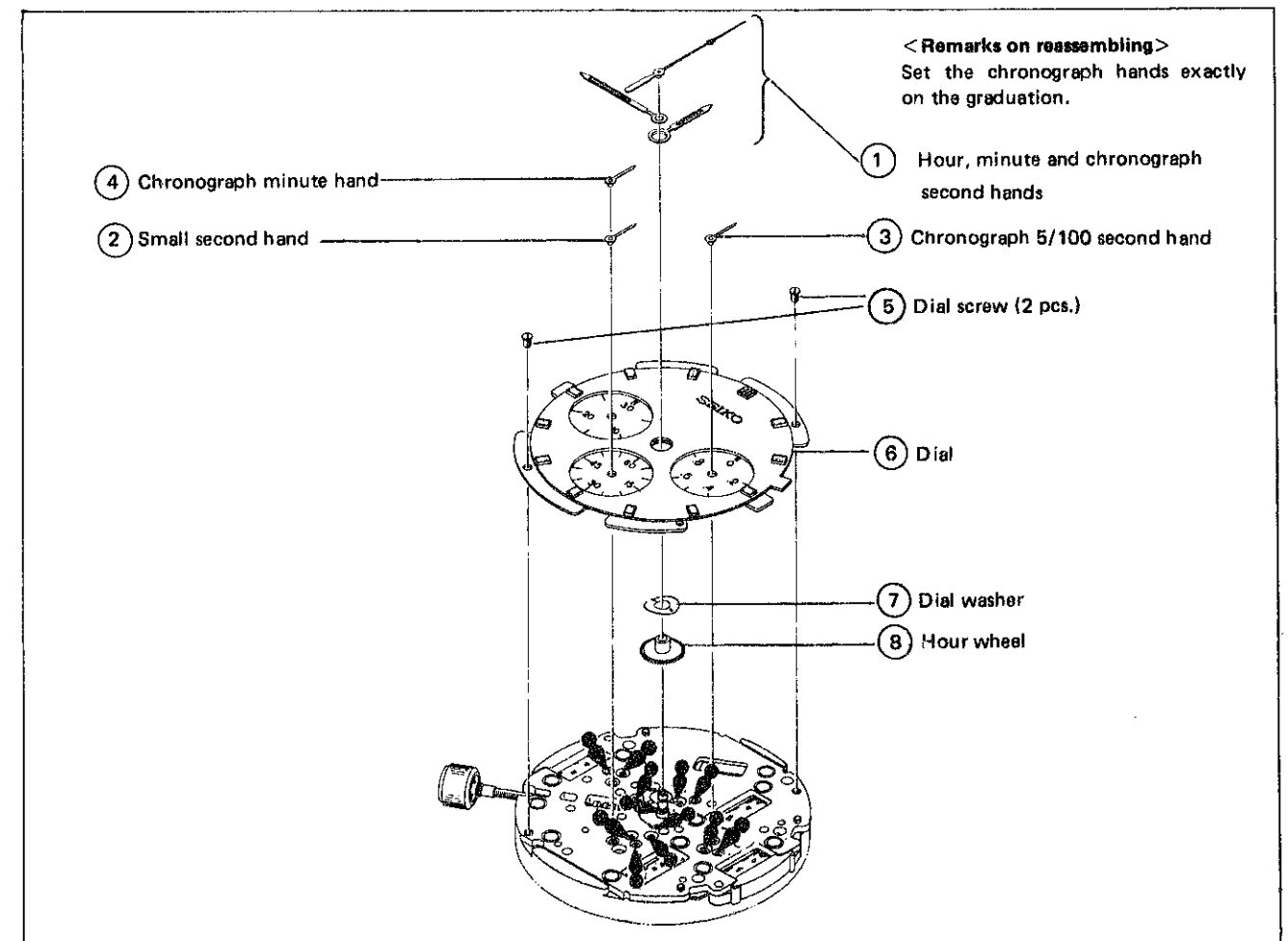

(2) Battery ~ Circuit block spacer

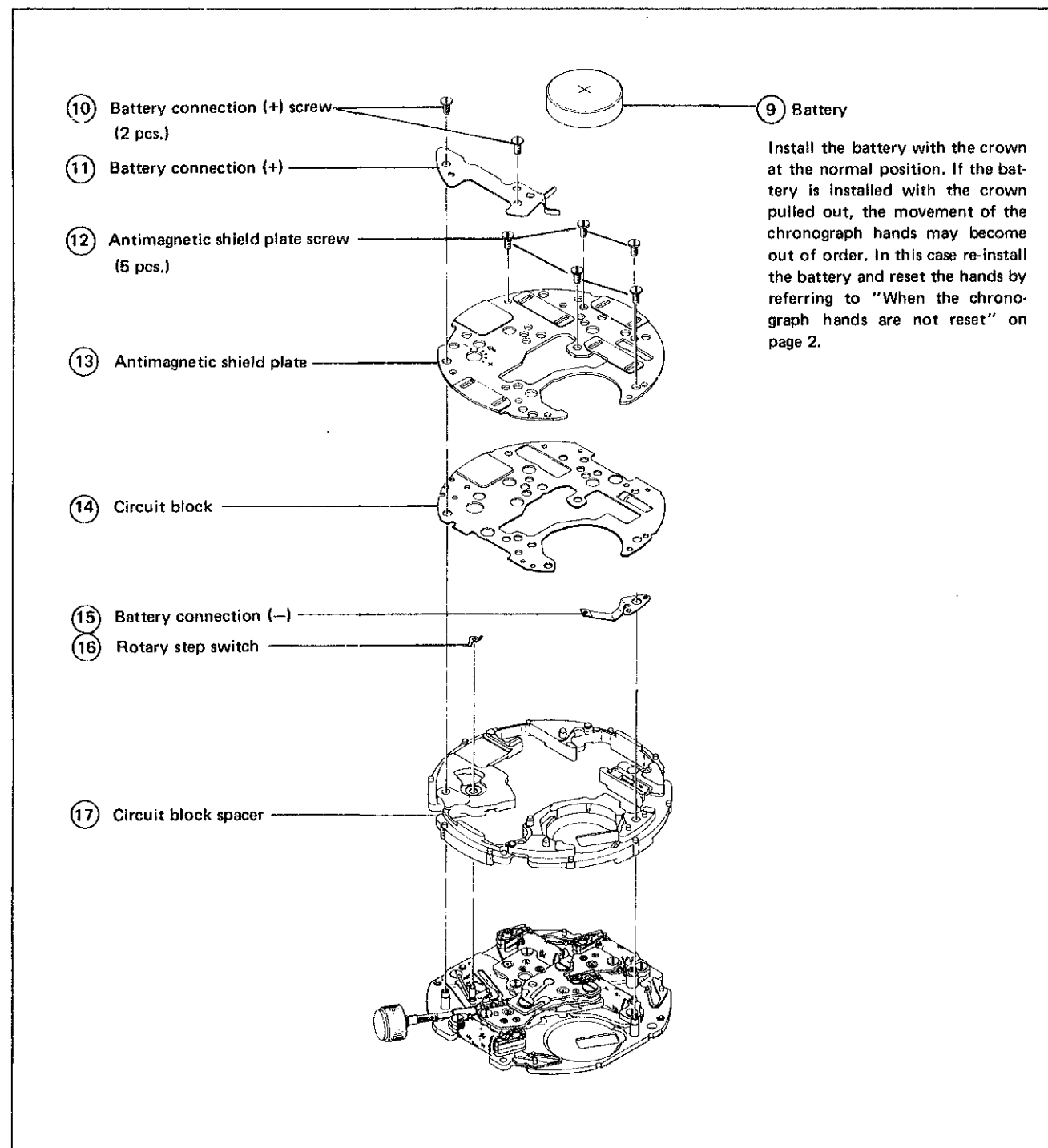

(3) Coil block screw ~ Intermediate minute wheel

There are many kinds of bridges, wheels and pinions, step rotors and coil blocks. The setting position of gear train is illustrated on page 7. Be sure not to set them by mistake. Refer to the chart on page 8 for identifying them.

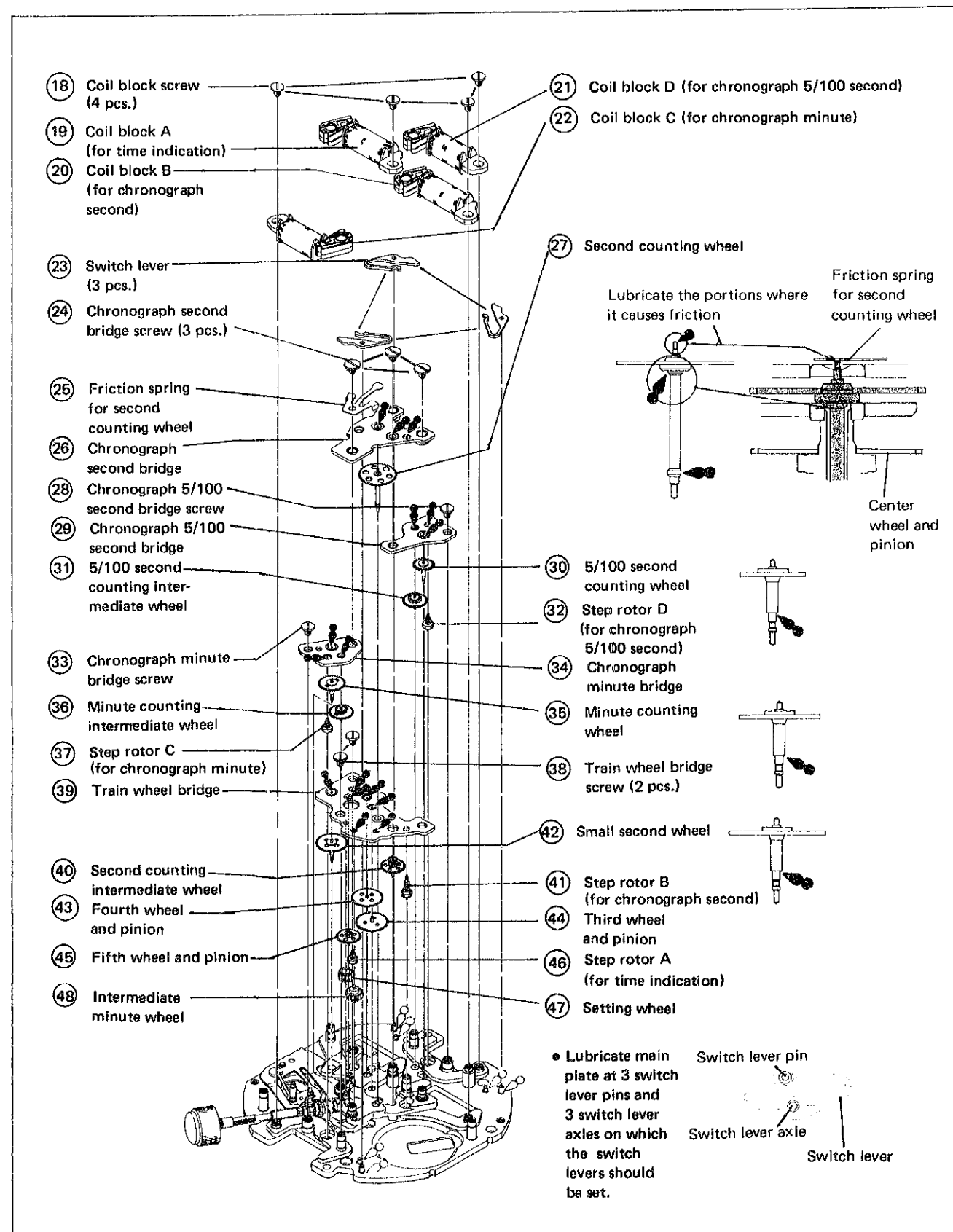

(4) Setting lever spring screw ~ Main plate

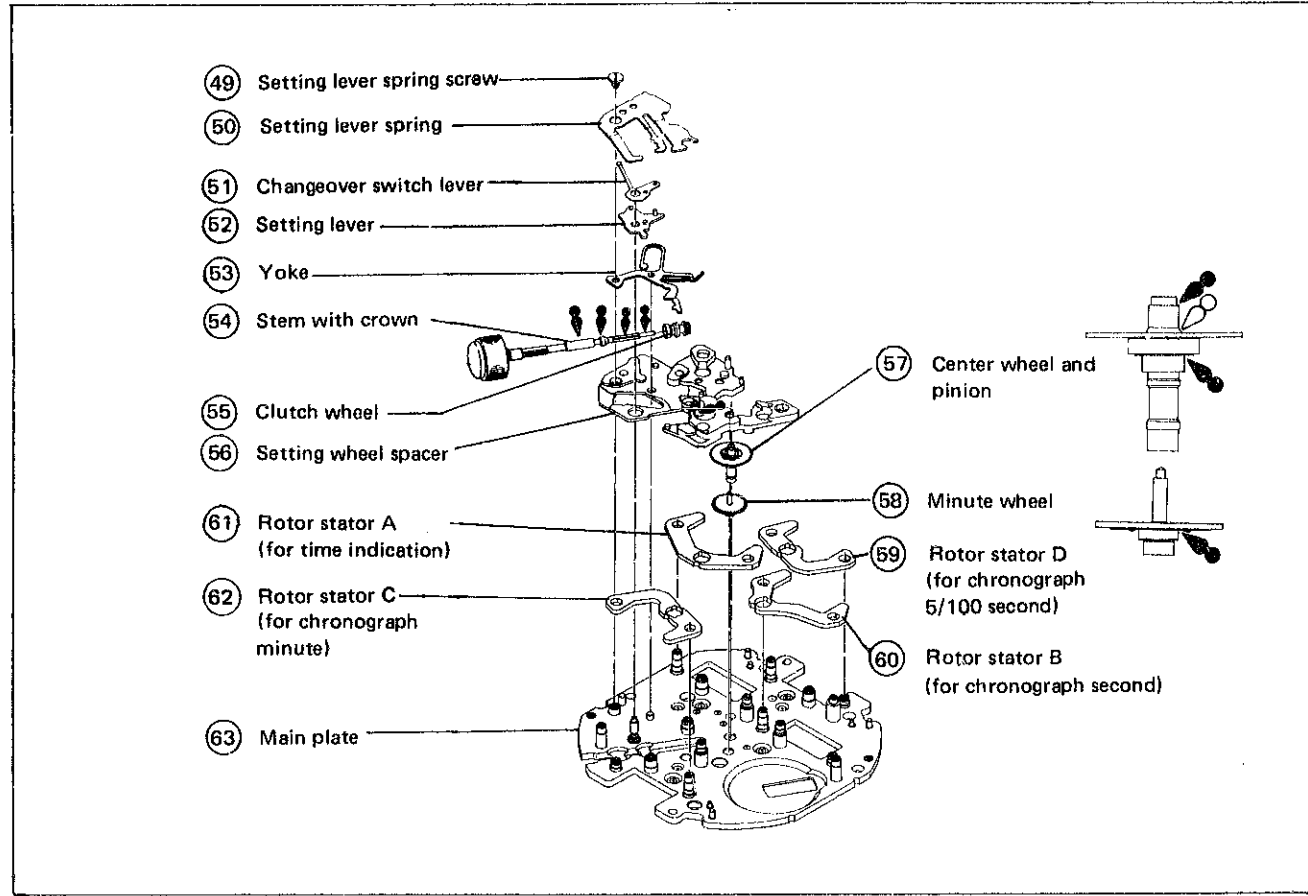

● Setting position of gear train

Upper hole jewel for step rotor is set upside down in the train wheel bridge to facilitate assembly of the step rotor.

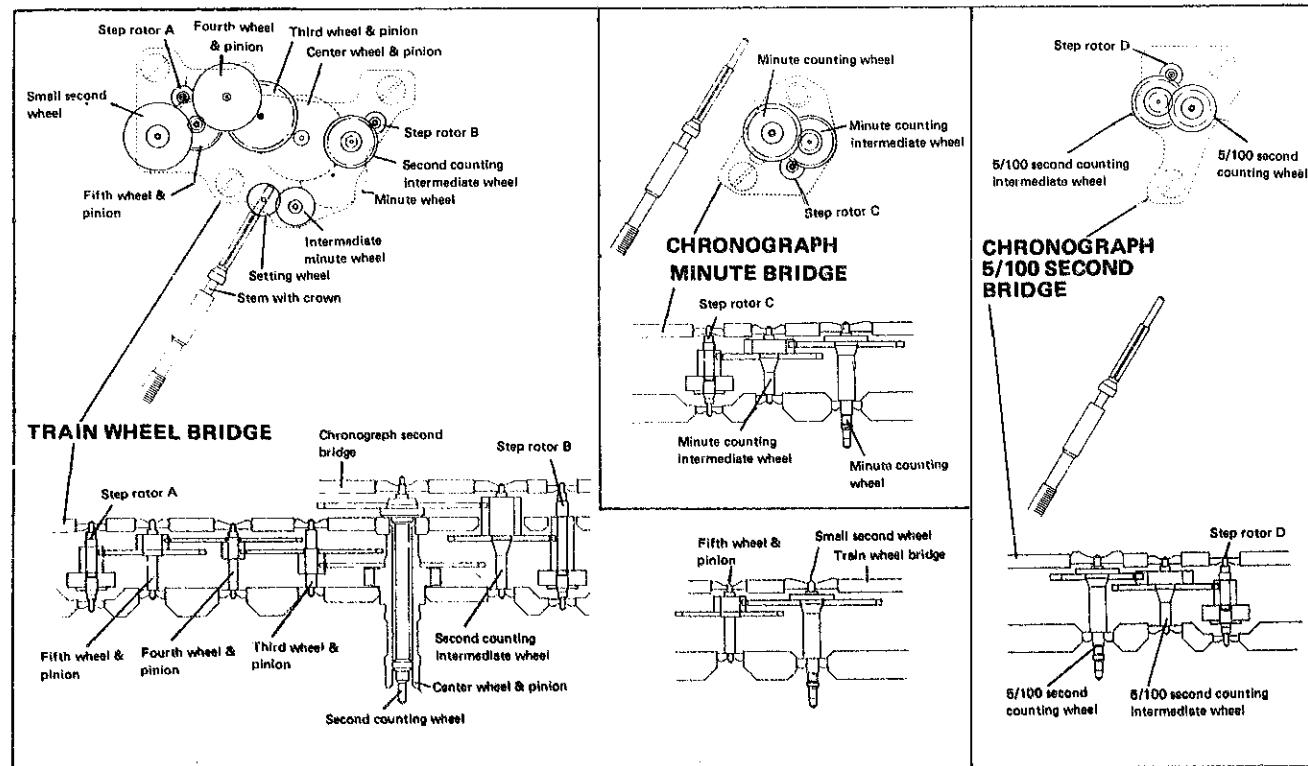

● Chart of the parts of the gear train mechanism and the setting mechanism

Bridge	Wheel & pinion	Step rotor	Rotor stator & coil block
Chronograph second bridge	Second counting wheel	Step rotor D (for chronograph 5/100 second)	Coil block D (540 mm)
	5/100 second counting intermediate wheel		Stator D
Chronograph minute bridge	Minute counting wheel	Step rotor C (for chronograph minute)	Coil block C
	Minute counting intermediate wheel		Rotor stator C
Train wheel bridge	Second counting intermediate wheel	Step rotor B (for chronograph second)	Coil block B (620 mm, same as coil block A)
	Center wheel & pinion		Rotor stator B
	Small second wheel	Step rotor A (for time indication)	Coil block A (620 mm)
	Minute wheel & pinion		Rotor stator A

V. CHECKING AND ADJUSTMENT

- The explanation here is only for the particular points of Cal. 7A28A.

Refer to the "TECHNICAL GUIDE, GENERAL INSTRUCTION" for SEIKO Analogue Quartz for details.

Procedure	
<p>CHECK OUTPUT SIGNAL</p> <p>Use the Quartz Tester. Range to be used: 10-second gate</p>	<p>Result: Normal: Input indicator blinks every second. Defective: Input indicator does not blink every second.</p>
<p>CHECK HAND CONDITION</p>	
<p>CHECK BATTERY VOLTAGE</p> <p>Set up the Volt-ohm-meter. Range to be used: DC 3V</p>	<p>Result: Normal: More than 1.5V Defective: Less than 1.5V</p>
<p>CHECK BATTERY CONDUCTIVITY</p>	
<p>CHECK CIRCUIT BLOCK CONDUCTIVITY</p>	
<p>CHECK COIL BLOCK</p> <p>Set up the Volt-ohm-meter. Range to be used: OHMS x 100</p>	<p>Result: For coil blocks A and B Normal: $2.4k\Omega \sim 3.0k\Omega$ Defective — Less than $2.4k\Omega$ (Short circuit) More than $3.0k\Omega$ (Broken wire)</p> <p>For coil blocks C and D Normal: $1.8k\Omega \sim 2.4k\Omega$ Defective — Less than $1.8k\Omega$ More than $2.4k\Omega$</p>

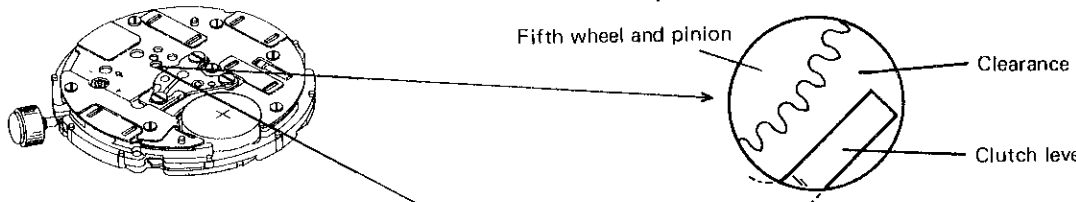
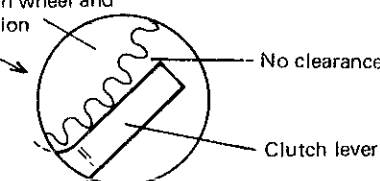
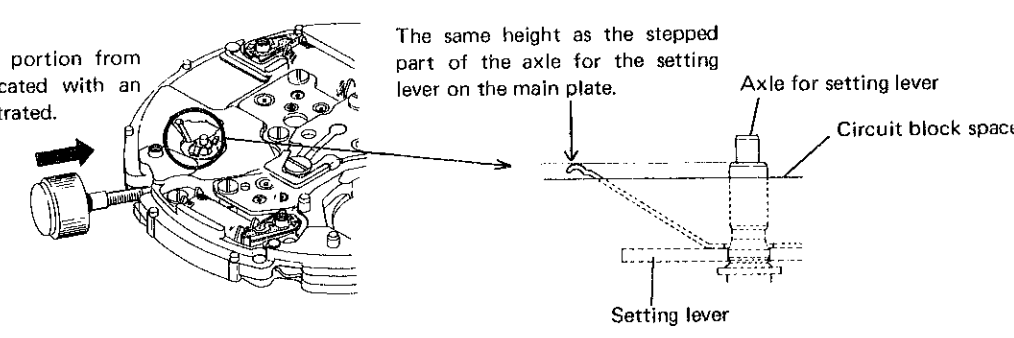
Procedure
<p>CHECK RESET AND TRAIN WHEEL SETTING CONDITION</p> <ol style="list-style-type: none"> Check to see if the small second hand is sure to stop when the crown is pulled out to the second click position and it starts advancing one second after the crown is pushed back to the normal position. Check the clearance between the fifth wheel and pinion and the clutch lever through the inspection hole on the antimagnetic shield plate. <ul style="list-style-type: none"> Crown at the normal and the first click position  Crown at the second click position  Remove the antimagnetic shield plate and the circuit block, and check the changeover switch lever for its tip height.  <p>The same height as the stepped part of the axle for the setting lever on the main plate.</p>
<p>CHECK GEAR TRAIN MECHANISM</p>

Procedure

CHECK ACCURACY

Measuring time accuracy

- Use the 10-second gate of the quartz tester.
- Be sure to protect the C-MOS-IC from light with case back or black paper, etc. while measuring.
- Do not check accuracy under an incandescent lamp since a strong light adversely affects time accuracy.

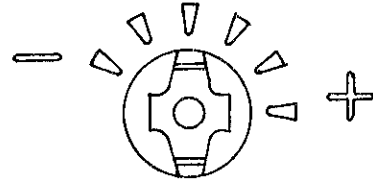

Adjusting time accuracy

- When adjusting time accuracy, do not activate stopwatch function.
- Turn the rotary step switch with tweezers and make correspond either end of it with a graduation on circuit bridge plate.
- The rotary step switch regulates 0.26 sec./day/step.

CHECK CURRENT CONSUMPTION

Set up the Volt-ohm-meter.

Range to be used: DC $12\mu\text{A}$ or DC $300\mu\text{A}$

- Be sure to protect C-MOS-IC from light with case back or black paper, etc. while measuring. Do not check current consumption under an incandescent lamp since a strong light causes a watch to consume excess current.

Result:

When stopwatch function is not activated.

Normal: Less than $1.8\mu\text{A}$

Defective: More than $1.8\mu\text{A}$

When stopwatch function is activated.

Normal: Less than $75\mu\text{A}$

Defective: More than $75\mu\text{A}$

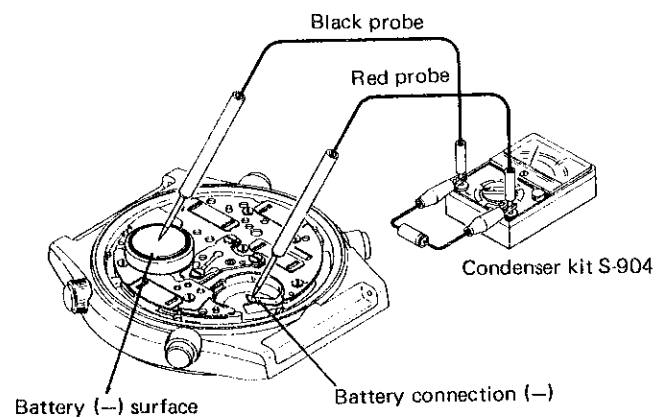

CHECK WATER RESISTANCE

CHECK CONDUCTIVITY OF SWITCH COMPONENTS

CHECK BATTERY LIFE INDICATOR

CHECK APPEARANCE AND FUNCTIONING

All procedures of Disassembling, Reassembling, Lubricating, Checking and Adjustment are completed.