

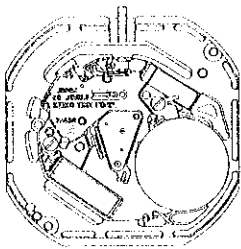

PARTS CATALOGUE / TECHNICAL GUIDE

Cal. 7N22A, 7N29A Cal. 7N33A, 7N42A, 7N43A

[SPECIFICATIONS]

Item		Cal. No.	7N22A	7N29A	7N33A	7N42A	7N43A
Movement							
			The illustrations refer to Cal. 7N43A. (x 1.5)				
Movement size	Outside diameter		21.5mm between 6 o'clock and 12 o'clock sides 20.6mm between 3 o'clock and 9 o'clock sides		21.5mm between 6 o'clock and 12 o'clock sides 21.3mm between 3 o'clock and 9 o'clock sides		23.5mm between 6 o'clock and 12 o'clock sides 23.5mm between 3 o'clock and 9 o'clock sides
	Casing diameter		21.5mm between 6 o'clock and 12 o'clock sides 19.2mm between 3 o'clock and 9 o'clock sides		21.5mm between 6 o'clock and 12 o'clock sides 21.3mm between 3 o'clock and 9 o'clock sides		23.5mm between 6 o'clock and 12 o'clock sides 21.9mm between 3 o'clock and 9 o'clock sides
	Height		2.6mm		2.9mm		
Time indication			3 hands	2 hands	3 hands		
Driving system			Step motor (Load compensated driving pulse type)				
Additional mechanism			Date calendar				
			Instant setting device for date calendar				
			-		Day calendar	-	Day calendar
			-		Instant setting device for day calendar	-	Instant setting device for day calendar
			Train wheel setting device	-	Train wheel setting device		
			Electronic circuit reset switch				
			Battery life indicator	-	Battery life indicator		
Loss/gain			Monthly rate at normal temperature range: less than 15 seconds				
Regulation system			Nil				
Measuring gate by quartz tester			Use 10-second gate.				
Battery			SEIKO SR920SW, Maxell SR920SW, SONY SR920SW, Matsushita SR920SW, EVEREADY 371 Battery life is approximately 3 years. Voltage: 1.55V				
Jewels			0 jewel				

PARTS CATALOGUE

Cal. 7N22A, 7N29A, 7N33A, 7N42A, 7N43A

Disassembling procedures Figs. : ① → ③⑥

Reassembling procedures Figs. : ③⑥ → ①

Lubricating: Types of oil

Moebius A

Oil quantity

Normal quantity

Ex. : Cal. 7N43A

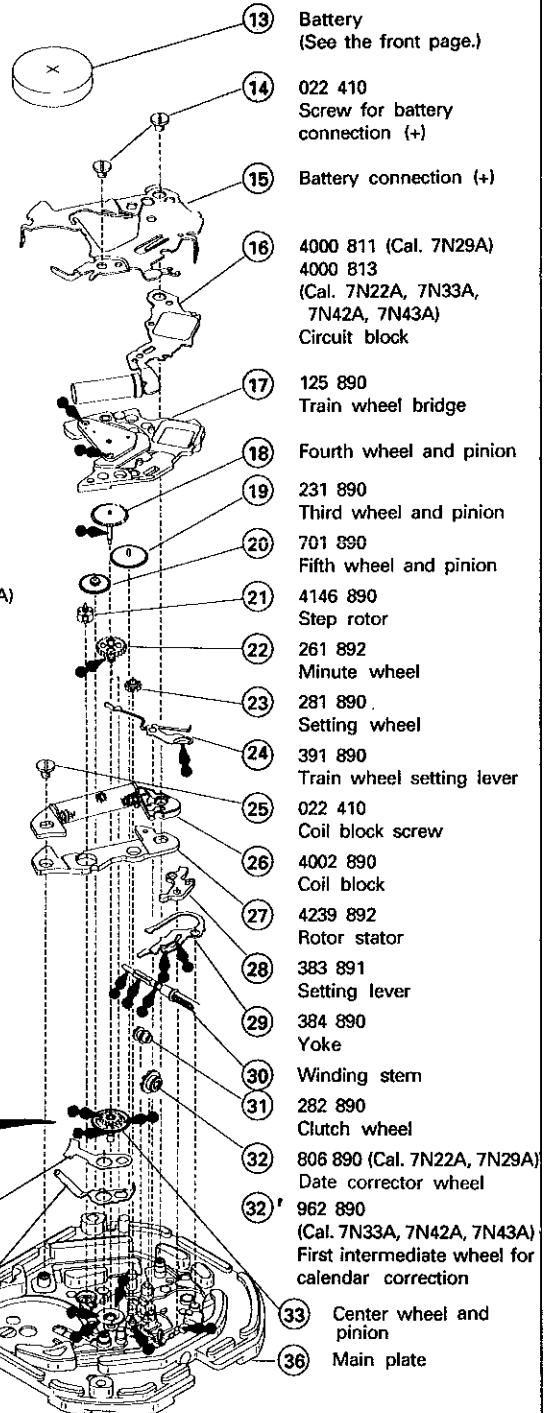
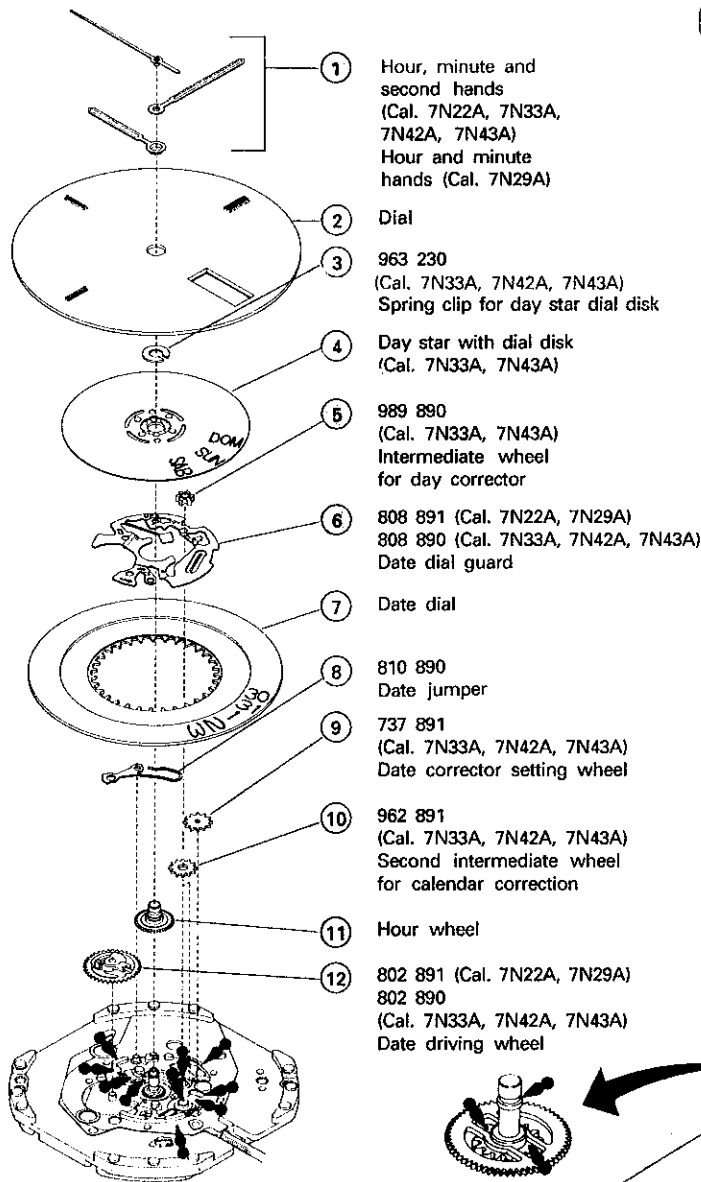
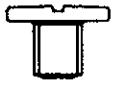
022 410
• Screw for battery connection (+)
• Coil block screw

- ③④ 4216 892 Insulator for battery connection
- ③⑤ 4270 890 Battery connection (-)

○ → Please see the remarks on the following pages.

PARTS CATALOGUE

Cal. 7N22A, 7N29A, 7N33A, 7N42A, 7N43A

Remarks:

- ①① Hour wheel
- ①⑧ Fourth wheel and pinion
- ③③ Center wheel and pinion

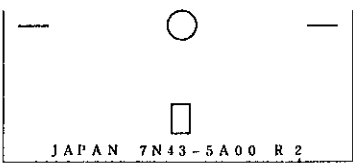
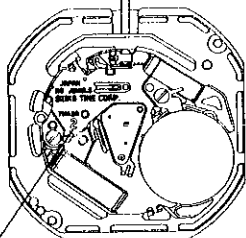

• **Discrimination of the installing height of the hands**

Cal. 7N series watches have numerals printed on the dial and the movement to indicate the installing heights of hands. When repairing, refer to the table below.

Discrimination	Height	Short type	Standard type	Extra long type
	Numeral for discrimination	1	2	4
Printed on		Dial		Movement
Printed position	Ex) Standard type			Ex) Standard type
		The numeral is printed at the right end.		
				The numeral is printed below the calibre number.

Combination:

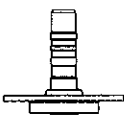
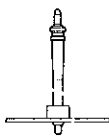



[Cal. 7N22A]

Numeral for discrimination	Center wheel and pinion	Fourth wheel and pinion	Hour wheel	Main plate
1	 221 889	 241 892	 271 894	 100 896

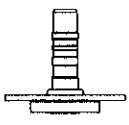
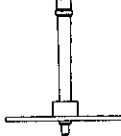

PARTS CATALOGUE

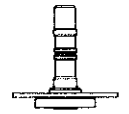
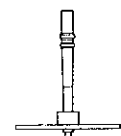
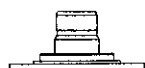
Cal. 7N22A, 7N29A, 7N33A, 7N42A, 7N43A

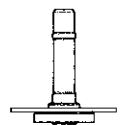
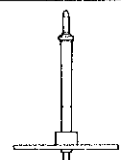
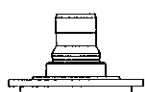

[Cal. 7N29A]

Numeral for discrimination	Center wheel and pinion	Fourth wheel and pinion	Hour wheel	Main plate
1	 221 889	 241 895	 271 894	 100 896
2	 221 895	 241 898	 271 895	 100 894

[Cal. 7N33A]

Numeral for discrimination	Center wheel and pinion	Fourth wheel and pinion	Hour wheel	Main plate
2	 221 896	 241 899	 271 893	 100 897

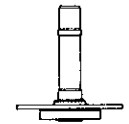
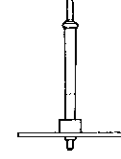
[Cal. 7N42A, 7N43A]

Numeral for discrimination	Center wheel and pinion	Fourth wheel and pinion	Hour wheel	Main plate
2	 221 896	 241 899	 271 893	 100 898

Note: When ordering the movement, specify the installing height of hands using the numeral for discrimination. If the numeral is not printed on the battery connection (+), check the dial for the numeral or see the tables above and find the numeral from the shape of the parts.

PARTS CATALOGUE

Cal. 7N22A, 7N29A, 7N33A, 7N42A, 7N43A

- ⑮ Battery connection (+) 4268 790

Note: The battery connection (+) we are supplying has no calibre number nor numeral printed on it for discriminating the installing height of hands.

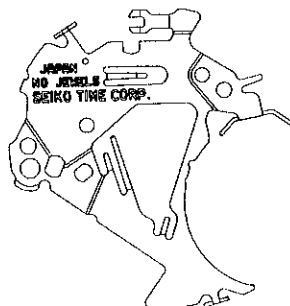

- ⑳ Winding stem 351 892

The type of winding stem is determined based on the design of cases. Check the case number and refer to "SEIKO Casing Parts Catalogue" to choose a corresponding winding stem.

TECHNICAL GUIDE

Cal. 7N22A, 7N29A, 7N33A, 7N42A, 7N43A

- The explanation here is only for the particular points of Cal. 7N22A, 7N29A, 7N33A, 7N42A and 7N43A.
- For the repairing, checking and measuring procedures, refer to the "TECHNICAL GUIDE, GENERAL INSTRUCTIONS".

I. STRUCTURE OF THE CIRCUIT BLOCK

[Cal. 7N22A, 7N33A, 7N42A, 7N43A]

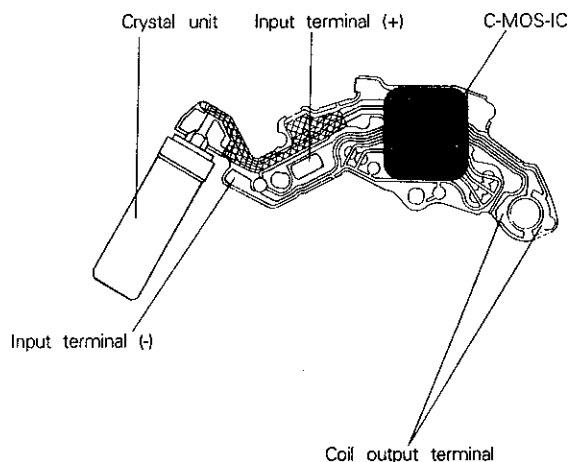

[Cal. 7N29A]

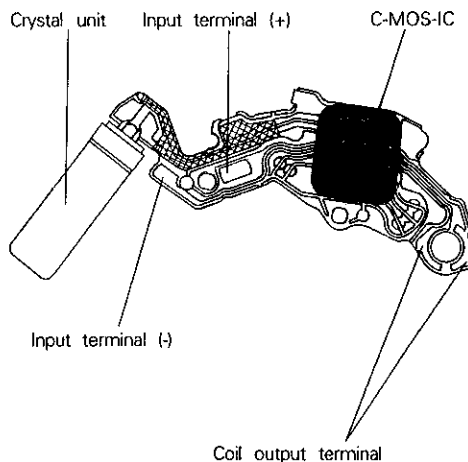

TECHNICAL GUIDE

Cal. 7N22A, 7N29A, 7N33A, 7N42A, 7N43A

II. REMARKS ON DISASSEMBLING AND REASSEMBLING

Use the universal movement holder for disassembling and reassembling.

① Hands

• Remarks on installing

When installing the hands, remove the battery and place the movement directly on a flat metal plate or the like.

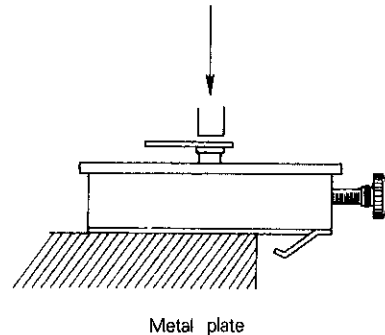

⑤ Intermediate wheel for day corrector (7N33A and 7N43A)

Set the intermediate wheel for day corrector in the direction as shown in the illustration at right.

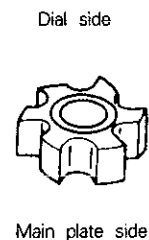

⑥ Date dial guard

Date dial guards are usually fixed with screws. However, the date dial guard for Cal. 7N22A, 7N29A, 7N33A, 7N42A and 7N43A has three protrusions to be caught under the main plate, and it is also fixed by two guide pins.

• How to remove

- 1) Lightly lift the A portion of the date dial guard with tweezers to release it from the guide pin, and then move it in the counterclockwise direction until it gets on the guide pin.
- 2) Release the B portion of the date dial guard in the same way as described above, and then move it in the counterclockwise direction until it gets on the guide pin.
- 3) Check that all the three protrusions of the date dial guard have come off from the main plate, and then remove the date dial guard.

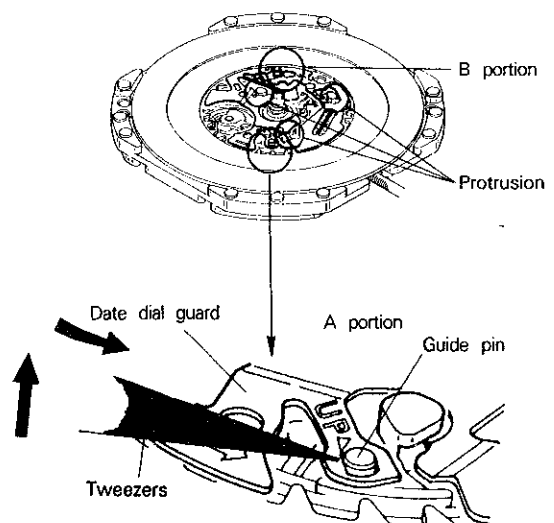

TECHNICAL GUIDE

Cal. 7N22A, 7N29A, 7N33A, 7N42A, 7N43A

• How to install

- 1) Put the date dial guard on the main plate so that the A and B portions are over the guide pins, as shown in the illustrations at right.
- 2) Move the protrusion D of the date dial guard in the clockwise direction so that it is caught under the main plate.
- 3) Slightly move the protrusions C and E in the clockwise direction alternately to set them under the main plate. Then, set the A and B portions of the date dial guard to the guide pins.
- 4) Check that the date dial guard is fixed securely to the main plate.

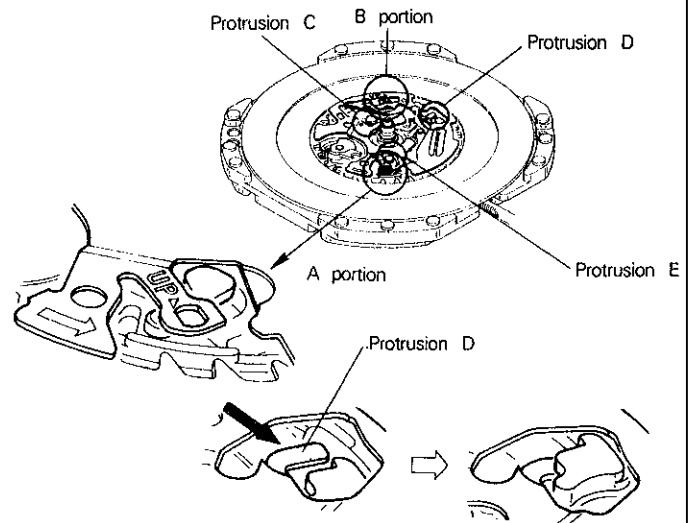

⑬ Battery

• How to install

Insert the battery aslant from the direction shown by the arrow.

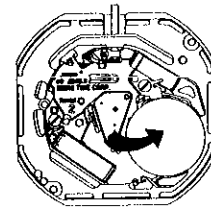

⑭ Screw for battery connection (+)

Fasten the screw on the crystal unit side while holding down the edge of the crystal unit.

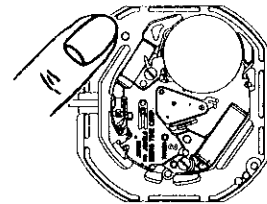

⑮ Battery connection (+)

• How to install

Have the hooking portion (2 places) catch the main plate.

In disassembling and reassembling, take care not to deform the hooking portions.

After installing the battery connection (+), check that the two hooking portions securely catch the main plate.

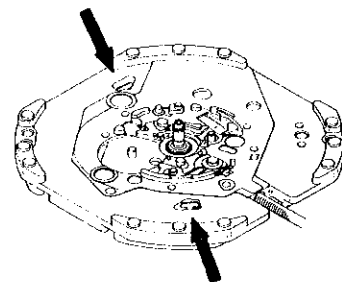

TECHNICAL GUIDE

Cal. 7N22A, 7N29A, 7N33A, 7N42A, 7N43A

⑰ Train wheel bridge

• Setting position

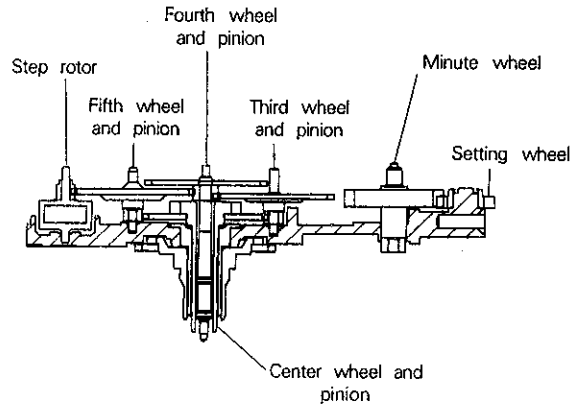
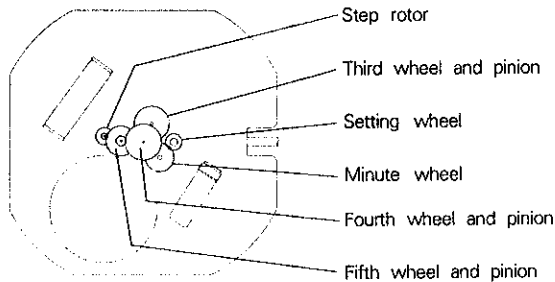

Note: Since the third wheel and pinion, fifth wheel and pinion, step rotor and minute wheel are made of plastic, take care not to damage them in disassembling and reassembling.

⑳ Train wheel setting lever

㉘ Setting lever

㉙ Yoke

• Setting position

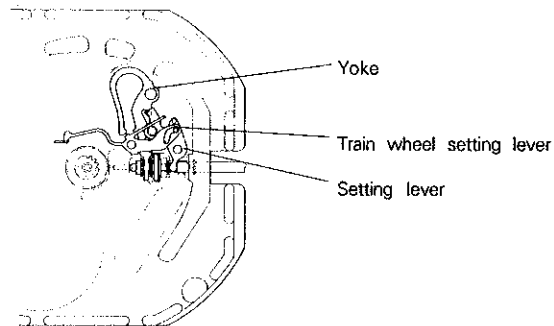

Note: Take care not to deform the spring portion of the yoke.

㉚ Winding stem

The first intermediate wheel for calendar correction (plastic) has some elasticity in the contact with the winding stem so that it can be easily fixed.

Push in the winding stem straight toward the center of the main plate.

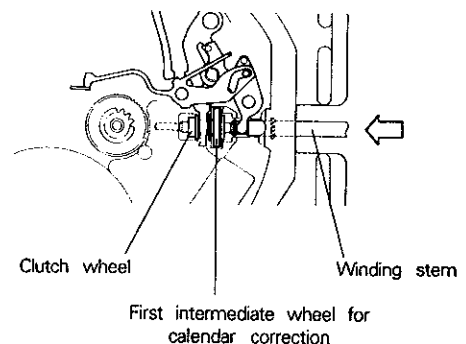

III. VALUE CHECKING

- Coil block resistance

2.4K Ω ~ 2.8K Ω

- Current consumption

For the whole of the movement: less than 1.3 μ A

For the circuit block alone : less than 0.4 μ A

Remarks: When the current consumption exceeds the standard value for the whole of the movement but within the standard value range for the circuit block alone, overhaul and clean the movement parts and then measure current consumption for the whole of the movement again. The reason for this is that the driving pulse generated to compensate for a heavy load that may be applied to the gear train, etc., is one possible cause of excessive current consumption by the whole of the movement.