

SEIKO

DIGITAL QUARTZ

Cal. A714A

**PARTS
CATALOGUE**

Cal. A714A

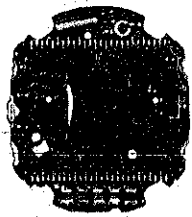
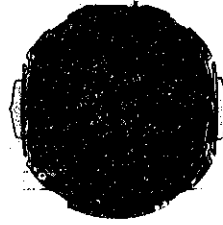
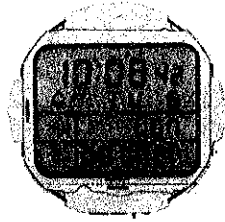

4001 762

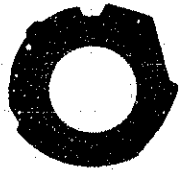

4225 762



4246 762



4270 795

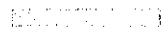

4313 762

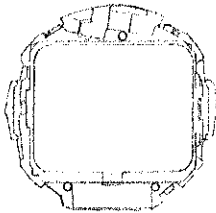

4398 762

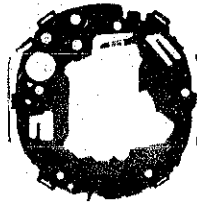

4410 764

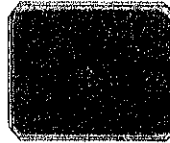

☆ 4510 515



4521 900

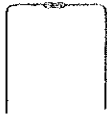

4530 230



☆ Matsushita BR2016

Cal. A714A

Characteristics

Casing diameter : ϕ 29.1 mm
 Maximum height : 5.1 mm without battery
 Frequency of quartz crystal oscillator : 32,768 Hz (Hz : Hertz Cycles per second)
 All functions in one display : The time and calendar display is shown in the upper row, the alarm function in the center row and the stopwatch function in the lower row.
 Time and calendar display : Hour (12-hour indication or 24-hour indication), minute, second, date, "A.M." "P.M." mark (displayed only in the 12-hour indication), and day of the week. (The month is displayed only when the calendar is adjusted.)
 Alarm display : Can be set to operate at any desired hour and minute every day.
 Stopwatch display : Digital display system showing minute, second and 1/100 second up to 20 minutes. And after 20 minutes, hour, minute and second up to 12 hours.
 Time signal : Can be set to ring every hour on the hour.
 Display medium : Nematic liquid crystal, FE-Mode.
 Regulation system : Trimmer condenser.
 Illuminating light : Illuminates all the digital displays in the dark by depressing the light button.

PART NO.	PART NAME	PAPT NO.	PART NAME	PART
4001 762	Circuit block			
4225 762	Battery clamp			
4246 762	Buzzer lead terminal			
4270 795	Battery connection (-)			
4313 762	Connector			
4398 762	Liquid crystal panel frame			
4410 764	Circuit bridge plate			
☆4510 515	Liquid crystal panel			
☆4510 516				
☆4510 517				
4521 900	Reflecting mirror (Silver)			
4521 901	Reflecting mirror (Gold)			
4530 230	Bulb			
☆ Matsushita BR2016	Lithium battery			
☆ Maxell CR2016				
☆ Sanyo CR2016				

Remarks :

Liquid crystal panel

☆4510 515 }
 ☆4510 516 } Be sure that combination between the color of panel cover and liquid crystal panel should
 ☆4510 517 } be matched according to the "SEIKO Quartz Casing Parts Catalogue".

Battery

☆ Matsushita BR2016 }
 ☆ Maxell CR2016 } In that case, please refer to separate "BATTERY LIST FOR SEIKO
 ☆ Sanyo CR2016 } QUARTZ WATCHES".

☆ ⇨ Please see remarks.

Part numbers in light letters are not shown in photos.

I. SPECIFICATIONS

Cal. No.		A714A
Item		
Display medium	Nematic Liquid Crystal, FEM (Field Effect Mode)	
Driving system	Multiplex driving system	
Display system	All functions in one display <ul style="list-style-type: none"> • Time and calendar display (12- or 24-hour indication) • Stopwatch display • Alarm time display 	
Additional mechanism	<ul style="list-style-type: none"> • Alarm test system • Hourly time signal • Pattern segment checking system • Illuminating light 	
Loss/gain	Loss/gain at normal temperature range Monthly rate: less than ± 15 seconds	
Module size	Outside diameter	$\phi 29.1$ mm
	Height	5.1 mm without battery
Regulation system	Trimmer condenser	
Measuring gate by quartz tester	Any gate is available.	
Battery	Lithium battery Matsushita BR2016, Maxell CR2016, Sanyo CR2016 Battery life: approx. 5 years Voltage: 3.0V	

II. STRUCTURE OF THE CIRCUIT BLOCK

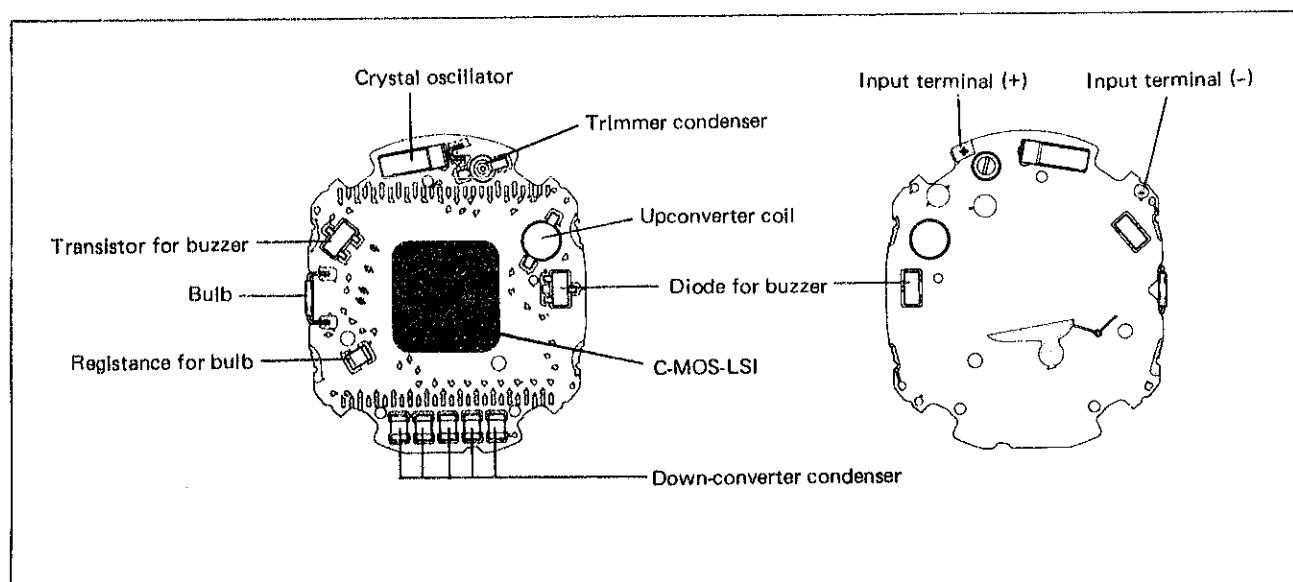

III. DISPLAY FUNCTION

- Check to see if the mode changes as shown below by depressing button A.

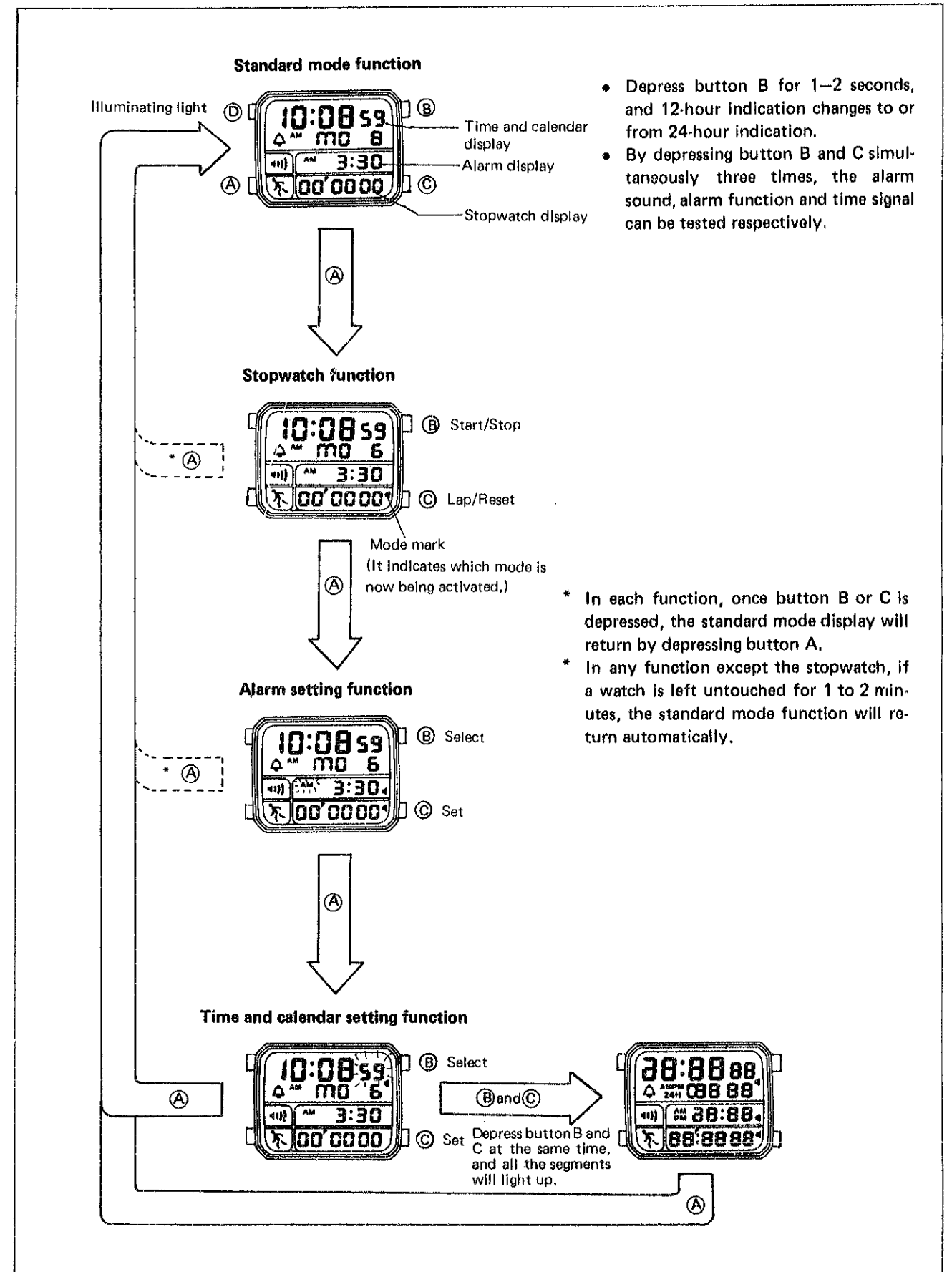

IV. DISASSEMBLING AND REASSEMBLING

1. Disassembling and reassembling of the module

Disassembling procedures: ① → ⑨

Reassembling procedures: ⑨ → ①

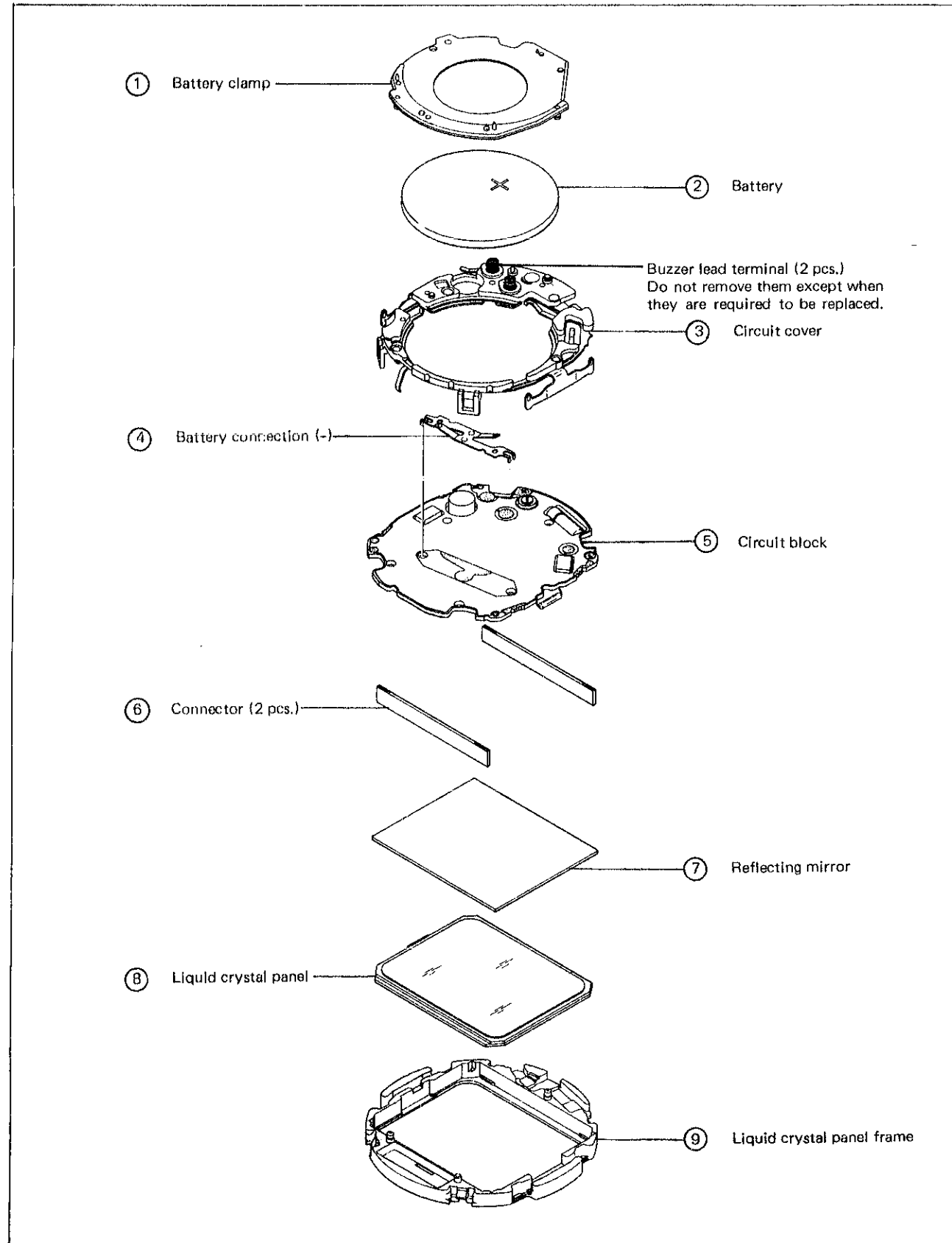

2. Relationship between the segment (Liquid crystal panel electrode) and the C-MOS-LSI output terminal

• Designation of segment

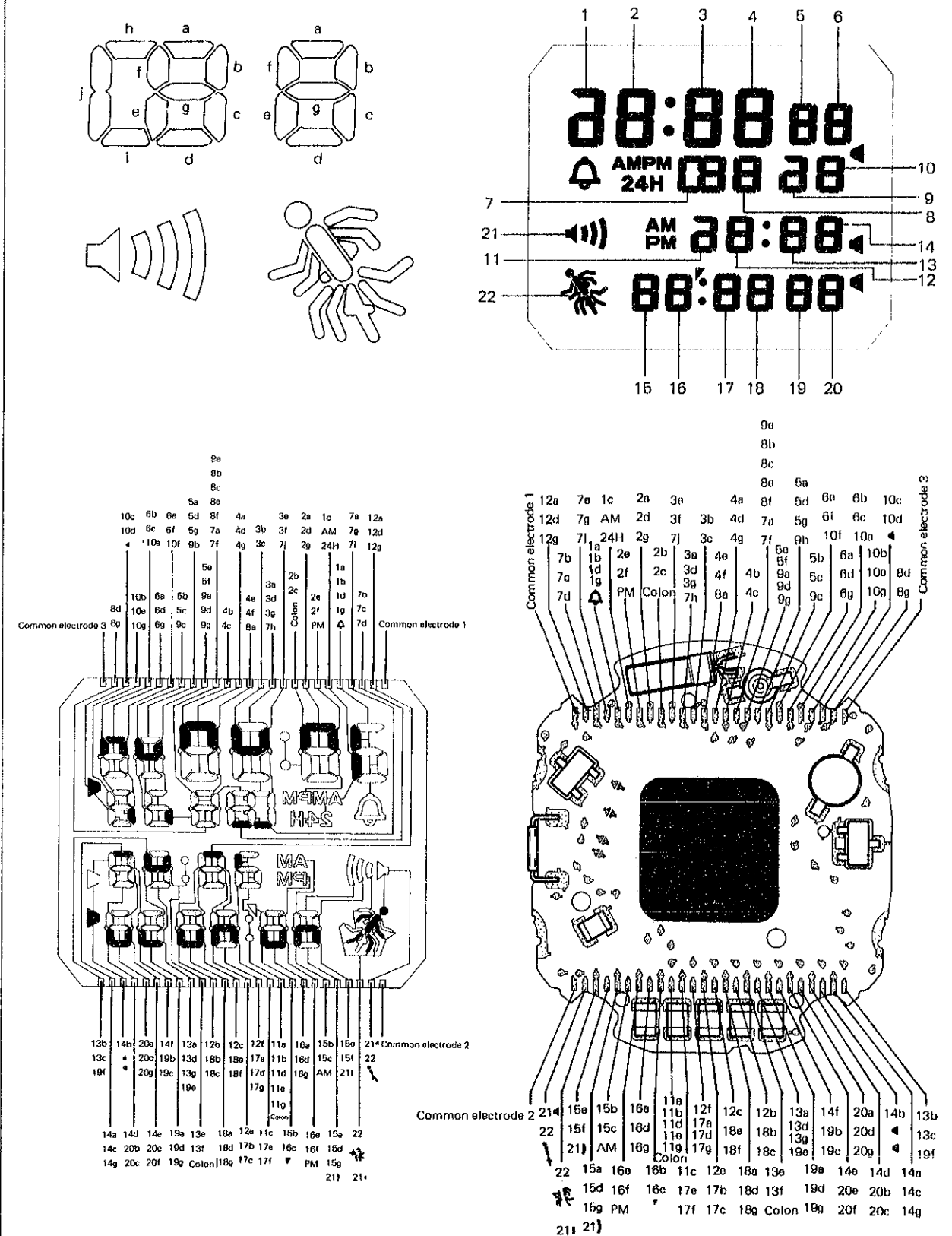

V. CHECKING AND ADJUSTMENT

- Refer to the "TECHNICAL GUIDE GENERAL INSTRUCTION" for SEIKO Digital Quartz for details.

Procedure	
<p>CHECK BATTERY VOLTAGE</p> <p>Set up the Volt-ohm meter. Range to be used: DC 6V</p>	<p>Result: Normal : More than 2.8V Defective: Less than 2.8V</p>
<p>CHECK BATTERY CONDUCTIVITY</p>	
<p>CHECK CURRENT CONSUMPTION</p> <p>Set up the Volt-ohm meter. Range to be used: DC 12μA</p> <ul style="list-style-type: none"> Current consumption for the whole of the module 	<p>Result: Normal : Less than 1.6μA Defective: More than 1.6μA</p>
<ul style="list-style-type: none"> Current consumption of the circuit block alone 	<p>Result: Normal : Less than 1.0μA Defective: More than 1.0μA</p>

Procedure	
<p>CHECK WATER RESISTANCE</p>	
<p>CHECK CONTACT BETWEEN C-MOS-LSI AND LIQUID CRYSTAL PANEL</p>	
<p>CHECK LIQUID CRYSTAL PANEL AND CIRCUIT BLOCK</p> <ul style="list-style-type: none"> Check the liquid crystal panel for broken wire and short circuit. Check the circuit block output voltage. 	
<p>CHECK ACCURACY</p> <p>Check the watch for accuracy with all segments displayed. (In time and calendar setting function, depress the button "B" and "C" at the same time, and all the segments light up.)</p>	
<p>CHECK ALARM TEST SYSTEM</p> <p>In the standard mode display, depress buttons "B" and "C" at the same time to check to see if the alarm rings.</p>	
<p>CHECK CONDUCTIVITY OF SWITCH COMPONENTS</p>	

Procedure

CHECK ALARM CONDITION

- (1) Check to see if there is any contamination on the connecting portion of the piezoelectric element and the buzzer lead terminal, and to see if there is any deformation of the buzzer lead terminal.
- (2) Measure the resistance for the upconverter coil of the circuit block and check it for broken wire and short circuit.

Volt-ohm meter
Range to be used: OHMS R x 1

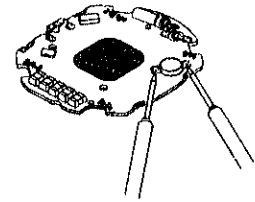

Result:
Normal: $40\Omega - 80\Omega$
Defective: $\left\{ \begin{array}{l} \text{Less than } 40\Omega \\ \text{More than } 80\Omega \end{array} \right.$

Apply the probes to the upconverter coil as shown above.

CHECK BULB CONDITION

Refer to "TECHNICAL INFORMATION NO.18" for how to replace the bulb.
After replacing the bulb, bend the leads of the bulb as shown below.

Be sure to bend the leads of the bulb so that the bulb rests at a height twice that of the circuit board.

$$A : B = 2 : 1$$

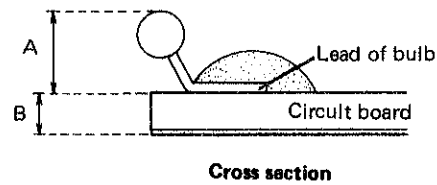

CHECK FUNCTIONING