

SEIKO

DIGITAL QUARTZ

Cal. F023A

PARTS LIST

Cal. F023A

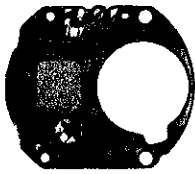

4001 190



4313 190

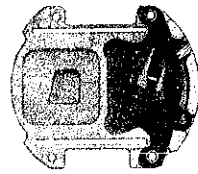

4398 037



4408 190

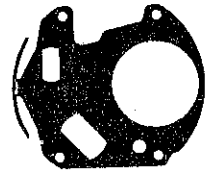

4457 191

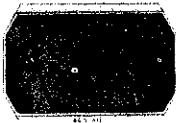

☆4510 011
☆4510 012



4540 190



SEIKO SB-DS

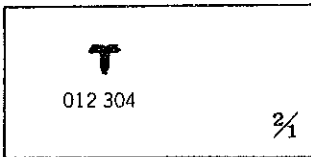

T
012 304

$\frac{2}{1}$

Cal. F023A

Characteristics

Casing diameter : ϕ 25.6 mm
 Maximum height : 3.3 mm
 Frequency of quartz crystal oscillator : 32,768 Hz (Hz=Hertz..... Cycles per second)
 Time functions : 12-hour Digital Display System showing hour, minute and second.
 The dots blink once every second.
 Calendar functions : Digital Display System showing month, day and date.
 Display medium : Single Crystal Display (Nematic Liquid Crystal, FE-Mode)
 Time micro-adjustor : Trimmer condenser system
 Battery life indicator : The entire display begins flashing.

PART NO.	PART NAME	PART NO.	PART NAME
4001 190	Circuit block		
4313 190	Connector		
4398 037	Battery guard		
4408 190	Insulating spacer for circuit block		
4457 191	Circuit block cover with switch spring		
☆4510 011	Liquid crystal panel (Black light digit)		
☆4510 012	Liquid crystal panel (Blue light digit)		
4540 190	Spring for liquid crystal panel		
012 304	Screw for circuit block cover with switch spring		
SEIKO SB-DS	Silver peroxide battery		

Remarks :

Liquid crystal panel

Be sure that the combination between the color of panel cover and liquid crystal panel should be matched according to the "SEIKO Quartz Casing Parts List".

TECHNICAL GUIDE

SEIKO

DIGITAL QUARTZ

CAL. F023A



CONTENTS

I. SPECIFICATIONS AND FEATURES	1
1. Specifications	1
2. Features	1
II. DISPLAY AND BUTTON OPERATION	2
1. Display	2
2. How to adjust the display	2
III. BATTERY LIFE INDICATOR	4
IV. AFTER-SALE SERVICING INSTRUMENTS AND MATERIALS	4
V. CASE	5
VI. DISASSEMBLING, REASSEMBLING AND CLEANING	7
1. Disassembling and reassembling	7
2. Cleaning	9
VII. CHECKING AND ADJUSTMENT	10
1. Guide table for checking and adjustment	10
2. Malfunction and checking points	11
3. Procedures for checking and adjustment	12
A. Check battery voltage	12
B. Check battery conductivity	12
C. Check conductivity of liquid crystal panel, circuit block, spacer for circuit block and connector	13
D. Check switch components	14
E. Check circuit block and liquid crystal panel	14
F. Check current consumption	15
G. Check accuracy	16
H. Check battery life indicator	16
I. Check functioning	17

Calibre F023A

Calibre F023A

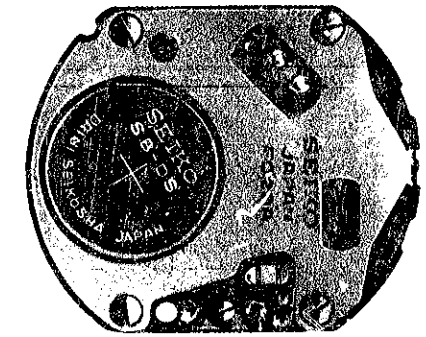
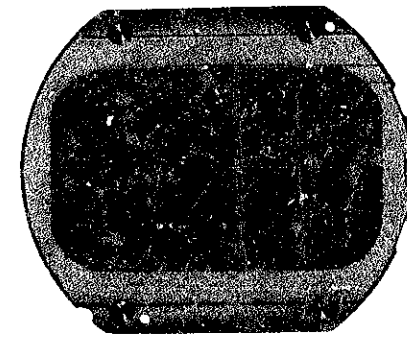

Module

I. SPECIFICATIONS AND FEATURES

1. Specifications

Item	Calibre No. F023A
Display medium	Nematic Liquid Crystal, FEM (Field Effect Mode)
Display system	<ul style="list-style-type: none"> Time display (Constant display) Hour & Minute: 12-hour digital display system Calendar display (when the time digits are displayed, depress button "A" and the Month/Date digits and then the Day digits are automatically displayed each for 2 seconds.) Month & Date: Automatic calendar System (except February of leap years) Day: Displayed in English Second display (After the day digits are displayed, the second digits are automatically displayed for 2 seconds. If button "A" is depressed when the second digits are being displayed, the display continues for about 4 to 5 minutes.)
Additional mechanism	Battery life indicator
Crystal oscillator	32,768 Hz (Hz = Hertz . . . Cycles per second)
Loss/gain	Loss/gain at normal temperature range Mean monthly rate : less than 10 seconds Annual rate: less than 2 minutes
Casing diameter	φ 25.6 mm (21.5 mm between 12 o'clock and 6 o'clock sides)
Height	3.3 mm without battery
Operational temperature range	-10°C ~ +60°C (14°F ~ 140°F)
Regulation system	Trimmer condenser
Battery power	SEIKO SB-DS silver peroxide battery Battery life is approximately 3 years. Voltage 1.5 V
IC (Integrated Circuit)	C-MOS-LSI 1 unit

2. Features

SEIKO THIN LC DIGITAL QUARTZ Cal. F023A is a compact and dress type men's quartz oscillator watch which conforms to the high accuracy and reliability for which the existing series of SEIKO LC DIGITAL QUARTZ are known.

- (1) In addition to the "hour" and "minute" digits, the "month/date," "day" and "second" digits are displayed automatically in turn by a single depression of a button.
- (2) It has an automatic calendar system, and therefore even and odd months except February of leap years are automatically adjusted.
- (3) Equipped with a battery life indicator, Cal. F023A signals the expiration of battery life in advance.
- (4) With the simplified block system of the module, it is easier to provide after-sale service.
- (5) As the day indicator almost fills the entire display panel when displayed, it can be read at a glance.

II. DISPLAY AND BUTTON OPERATION

1. Display

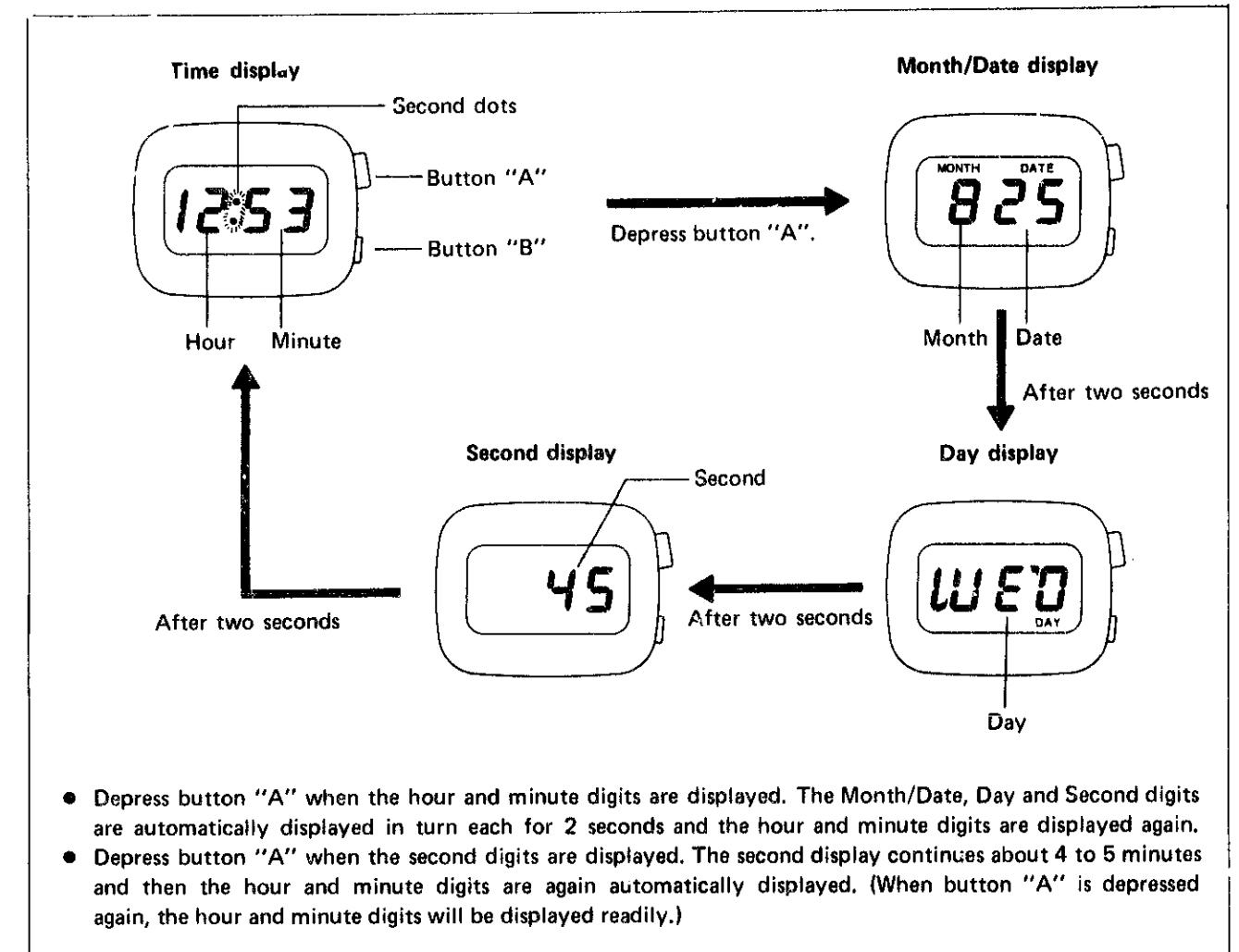

2. How to adjust the display



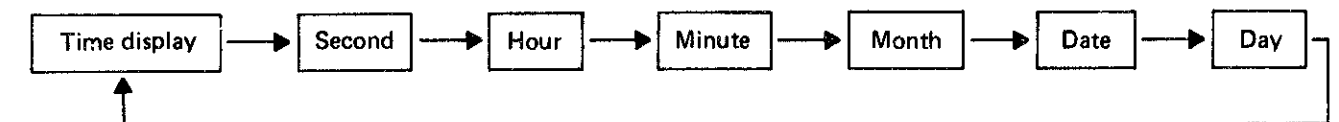





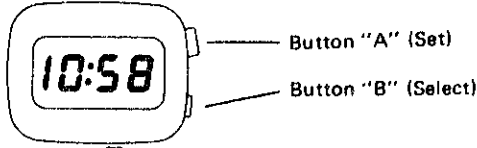

- (1) Each depression of button "B" will select the digits to be adjusted in the following order.

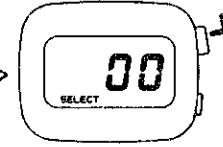

- (2) "SELECT" mark is displayed while digits are being adjusted.
- (3) One digit is advanced by each depression of button "A".

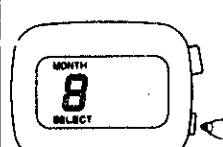
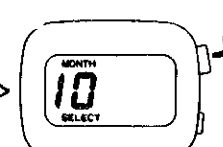
[Example]

How to change the indication of Wednesday, 10:58:40 A.M., September 23 into Friday, 9:35:00 P.M., October 15.

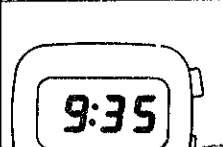
Button operation		
Digits to be adjusted	Select (Select the digits to be adjusted.) Depress button "B".	Set (Set the desired digits.) Depress button "A".
		
Second	Depress button "B" when the hour and minute digits are displayed. The second digits and the select mark are displayed.  "SELECT" mark (Displayed while the time and calendar digits are being adjusted.)	Depress button "A" in accordance with "00" second of a time signal. The seconds are then reset to "00" and start immediately.* 
Hour	Depress button "B". The hour digits, "A" (stands for A.M.) or "P" (stands for P.M.) and select mark are displayed. 	Depress button "A". One digit (hour) is advanced by each depression of button "A". While setting the hour, be sure to check if it is set in the A.M. (A) or P.M. (P). 
Minute	Depress button "B". The minute digits and select mark are displayed. 	Depress button "A". One digit (minute) is advanced by each depression of button "A". 
Month	Depress button "B". The month digits and select mark are displayed. 	Depress button "A". One digit (month) is advanced by each depression of button "A". 
Date	Depress button "B". The date digits and select mark are displayed. 	Depress button "A". One digit (date) is advanced by each depression of button "A". 
Day	Depress button "B". The day indicator and select mark are displayed. 	Depress button "A". One day is advanced by each depression of button "A". 
Adjustment is completed	After the entire adjustment is completed, depress button "B" and the hour and minute digits are displayed. 	

* When the seconds count any numbers from "00" to "29" the seconds are reset to "00" automatically whenever button "A" is depressed. When the seconds count any numbers from "30" to "59" and button "A" is depressed, one minute is added and the seconds immediately return to "00".

III. BATTERY LIFE INDICATOR

- The battery life indicator starts the entire display flashing every second when the battery life is coming to its end. However, the watch will remain accurate while the entire display is flashing.
- **Note for handling the battery**
Be sure to place the battery with its (-) surface up whenever it is disassembled.

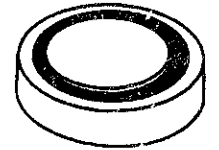

IV. AFTER-SALE SERVICING INSTRUMENTS AND MATERIALS

For after-sale servicing of SEIKO Thin LC Digital Quartz Cal. F023A, the following instruments and materials are necessary.

1. Quartz Tester
Used to check time accuracy (daily rate).

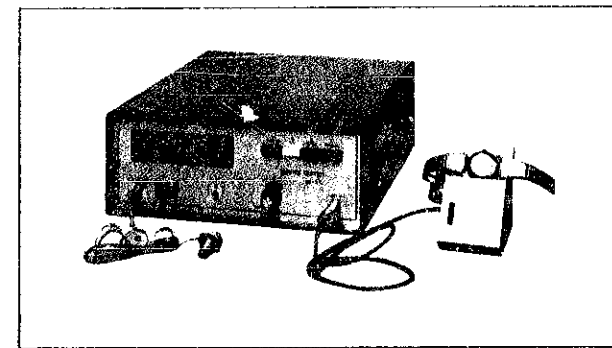

2. Micro Test
Used to check current consumption and to supply constant voltage power.

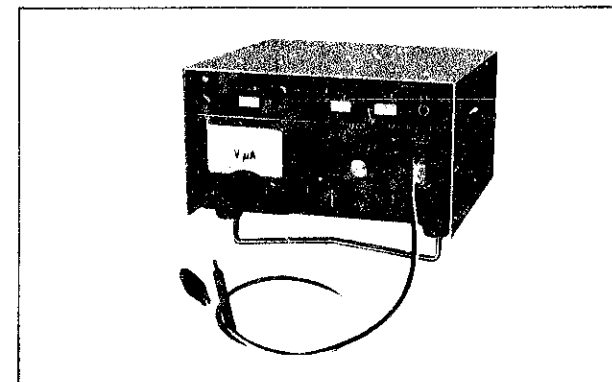

3. Volt-ohm-meter (S-831)
Used to check battery voltage and its conductivity.

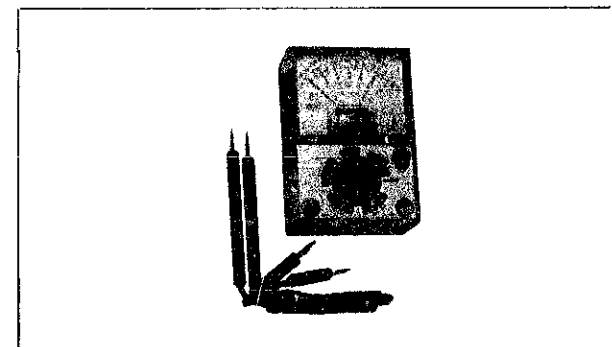

4. Current supplier (S-833)
Used to supply constant voltage power to check the electronic circuit block.

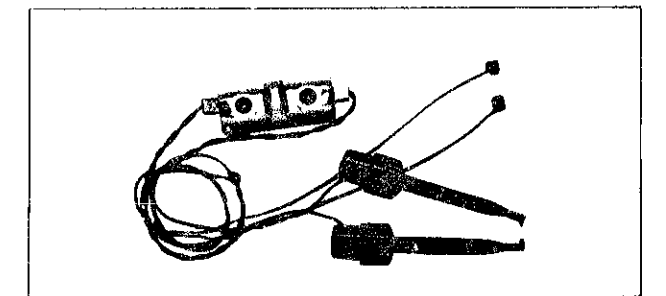

5. Static electricity protector (S-830)
Used to protect the electronic circuit block of Digital Quartz from being damaged by static electricity.

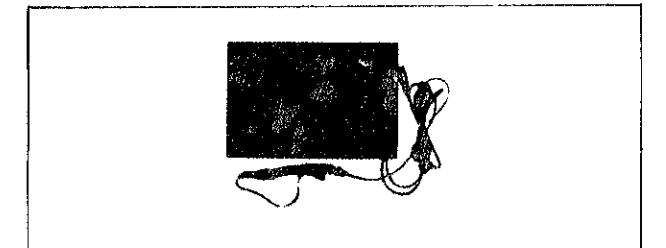

6. Inserting disk (S-162)
Used to disassemble the glass.

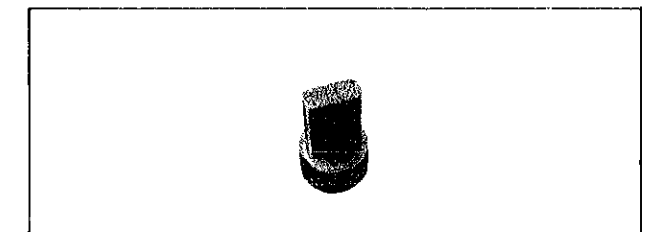

7. Plastic supporting disk (S-173)
Used to reassemble the glass.

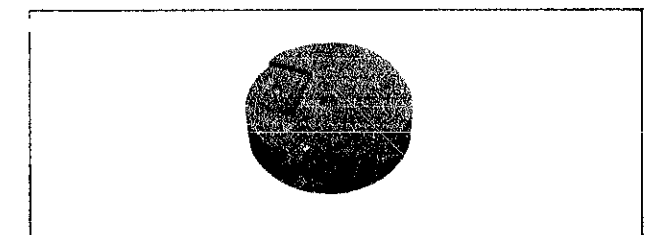

(The module holder is not necessary for this calibre. Disassemble and reassemble the module on the static electricity protector.)

V. CASE

1. How to disassemble the module

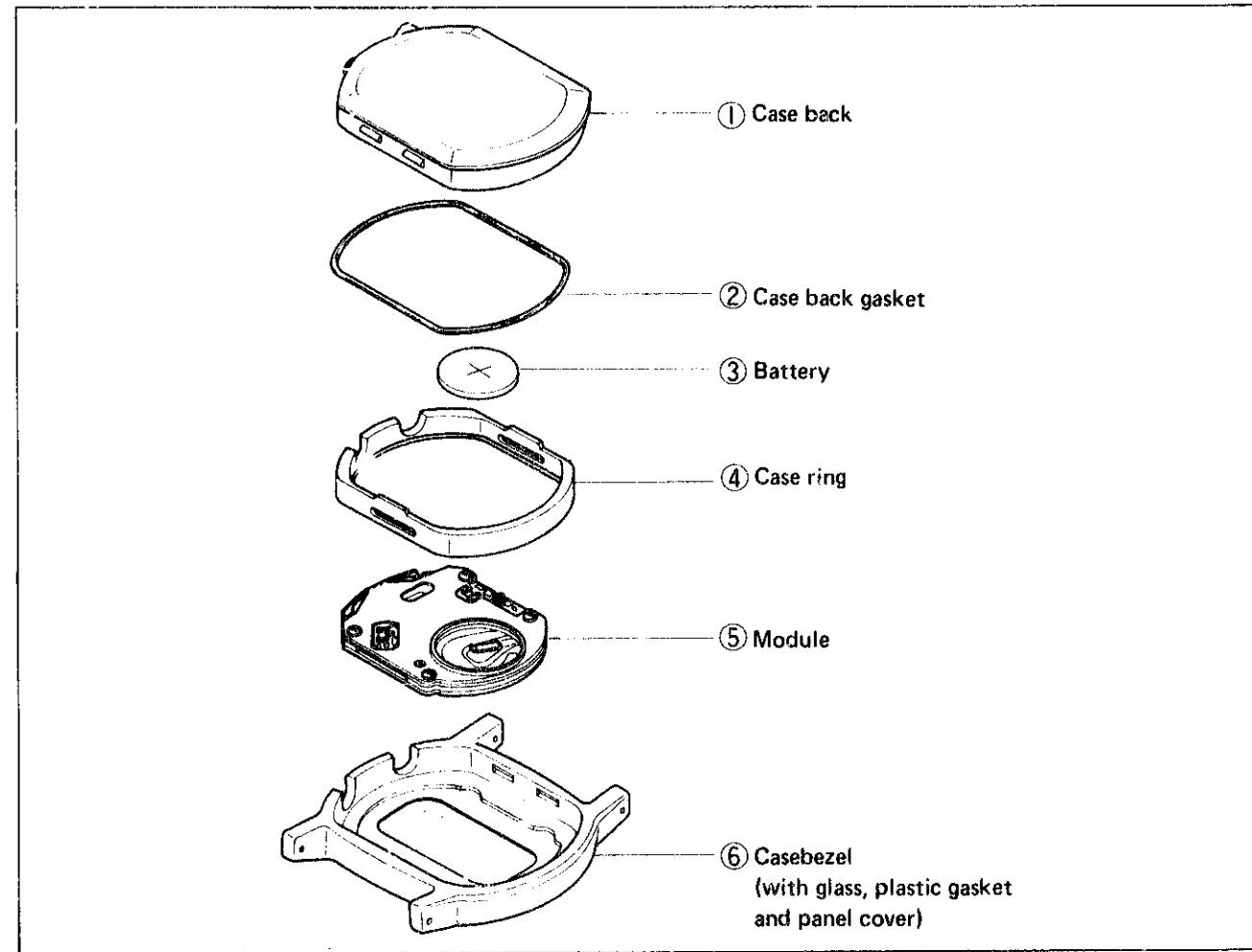

2. How to disassemble the glass

Do not disassemble the glass except when it is required to be replaced.

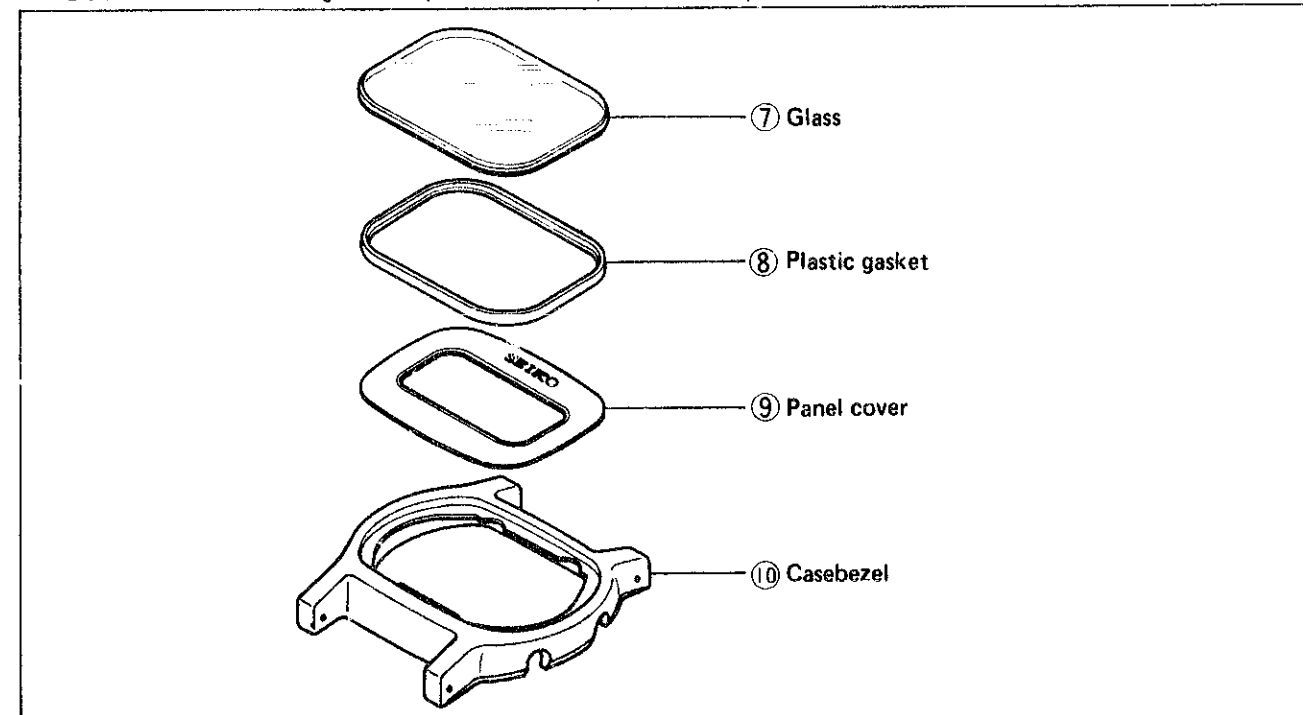

Remarks for disassembling and reassembling HOW TO REASSEMBLE THE CASE BACK

Reassemble the case back with the set and select buttons in a "PULLED OUT" position. The switch portions might be damaged if the case back is reassembled without the set and select buttons in a "PULLED OUT" position.

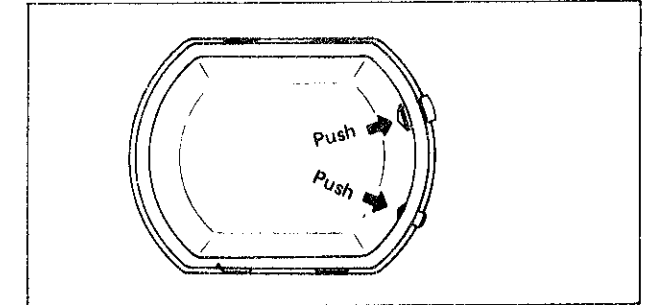

HOW TO DISASSEMBLE THE BUTTONS

- Lubricating  : Silicon grease 500,000 C.S., normal quantity
- Set button (button "A")
Disassemble the hook-up for set button and then pull the set button outward for disassembling.
- Select button (button "B")
Push the select button inward for disassembling.

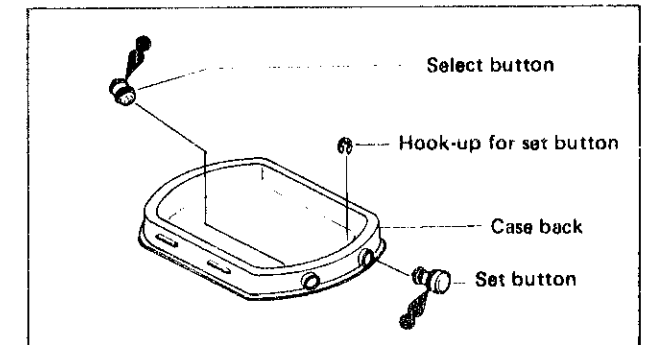

HOW TO REPLACE THE GLASS

- How to disassemble the glass (Use the tightening tool S-220)
Use the inserting disk (S-162) to push the glass from inside for disassembling.
Be careful not to depress the panel cover.
Supporting disk: Select the supporting disk whose diameter is larger than that of the glass.

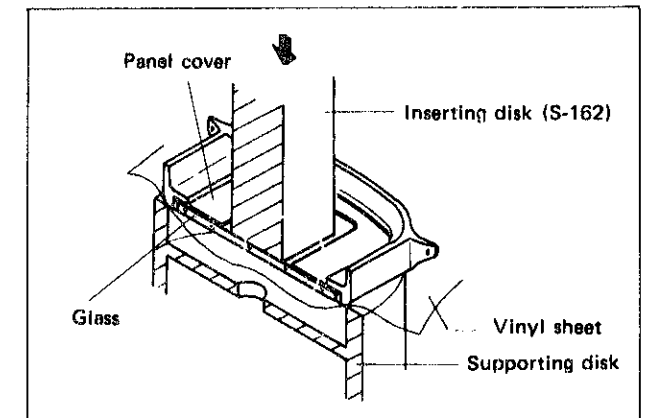

- How to reassemble the glass
Use the inserting disk (S-173).
Supporting disk: Select the supporting disk contained in S-160 Disk unit, whose diameter is smaller than the inside diameter of the casebezel.

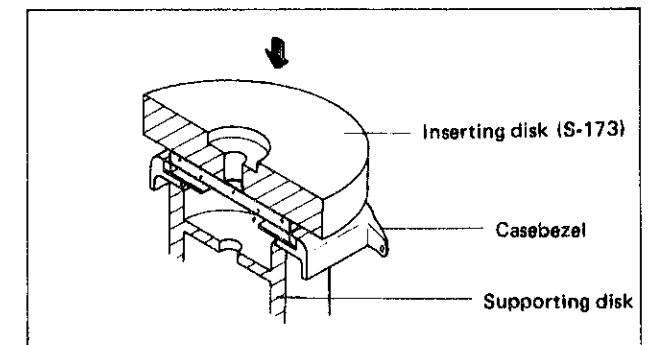

- Plastic gasket
Be sure to replace the plastic gasket with a new one when the glass is disassembled.
Be careful not to mistake the upper side for the lower side.

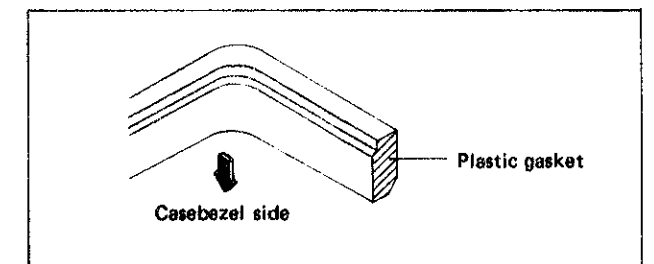

VI. DISASSEMBLING, REASSEMBLING AND CLEANING

Disassembling procedures Figs. : ① ~ ⑧

Reassembling procedures Figs. : ⑧ ~ ①

1. Disassembling and reassembling

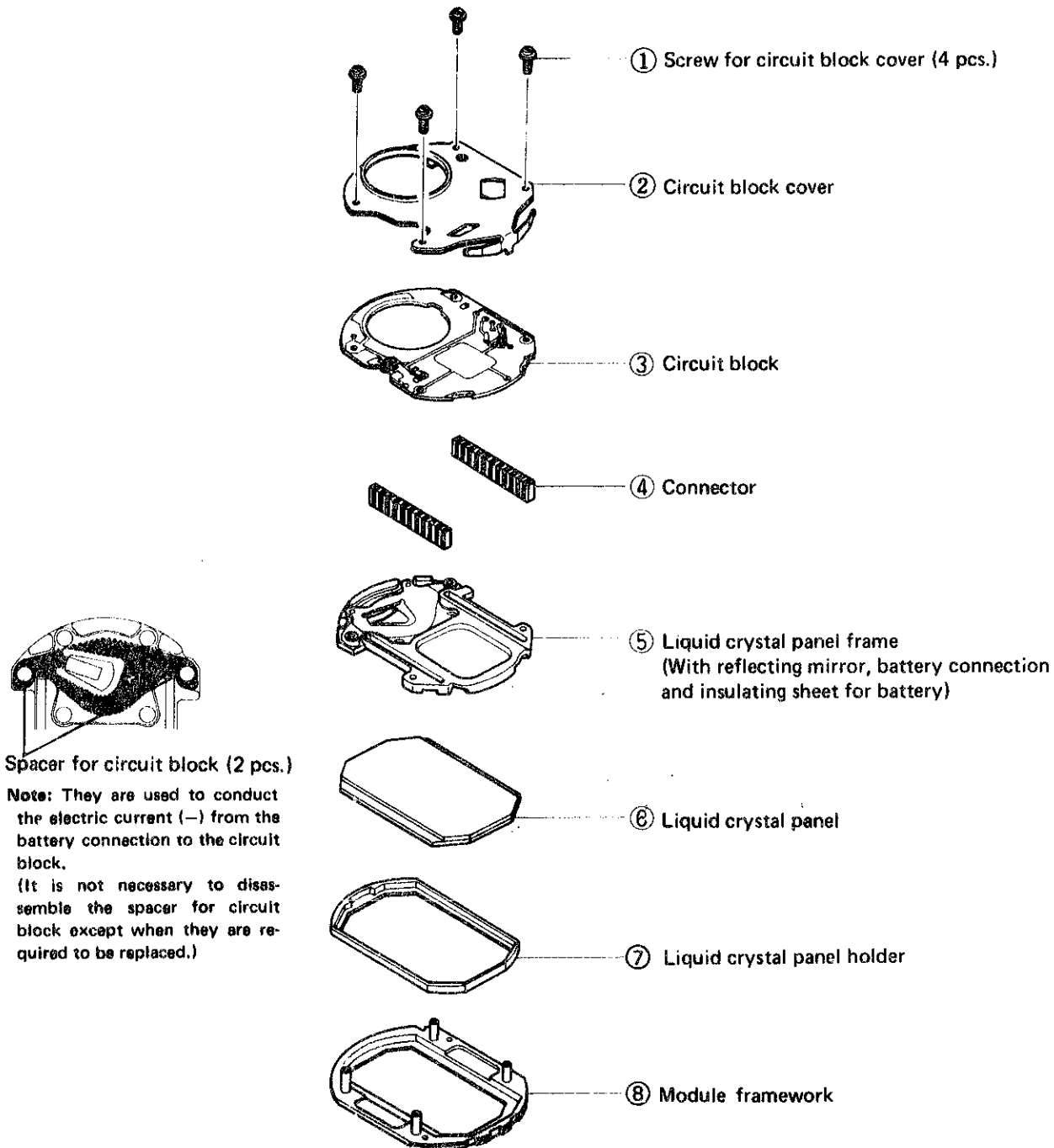

Remarks for disassembling and reassembling

① Screw for circuit block cover

Tighten the two screws on the battery side first.

④ Connector

Although two connectors are used, there is no difference between the two.

The black portions are conductive. Check to see if there are no scratches, or contamination.

⑤ Liquid crystal panel frame

How to disassemble from module framework.

Push the tip of a screwdriver into the arrow-marked portions and pry up gradually for disassembling. Be careful not to scratch the reflecting mirror.

Check to see if the spacer for circuit block is fixed to the liquid crystal panel frame.

As the liquid crystal panel frame is combined with the reflecting mirror, battery connection and insulator for battery connection, disassemble them as one combined unit.

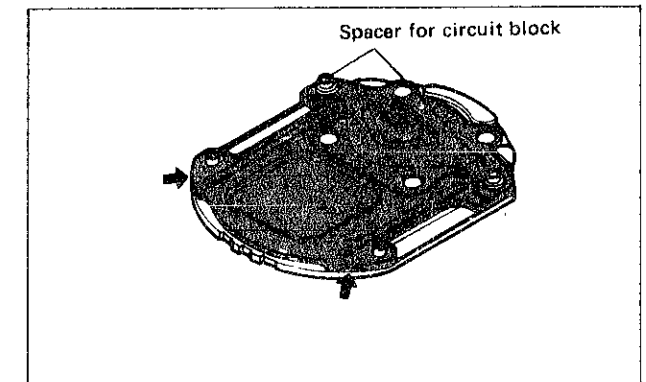

⑥ Liquid crystal panel

Use fingercots to disassemble and reassemble the liquid crystal panel. Be careful not to push the surface of the liquid crystal panel too hard.

How to reassemble

Reassemble the liquid crystal panel in such a way that its part number portion comes to the upper side when the arrow-marked portions (button position) of the module framework are on the right side.

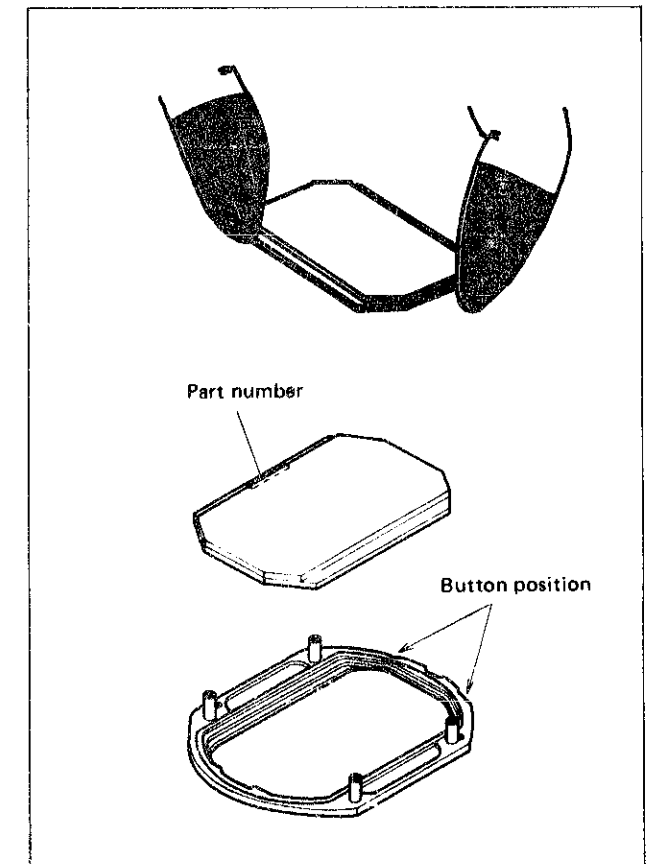

2. Cleaning

1) HOW TO CLEAN

Name of parts	Cleaning	Drying	Solution	Remarks
Connector 	Rise or wash with a soft brush.	Cool air	Alcohol	<ul style="list-style-type: none"> Do not use benzine or trichloroethylene as they expand the connector. Be sure to reassemble after drying thoroughly.
Plastic parts (liquid crystal panel holder)	Rinse or wash with a soft brush.	Cool air	Benzine or alcohol	
Other parts <ul style="list-style-type: none"> Circuit block cover Module framework 	Rinse or wash with a soft brush.	Cool or hot air	Benzine, trichloroethylene or alcohol	<ul style="list-style-type: none"> Be careful not to bend the switch spring portion of the circuit block cover when cleaning.

2) PARTS THAT MUST NOT BE CLEANED

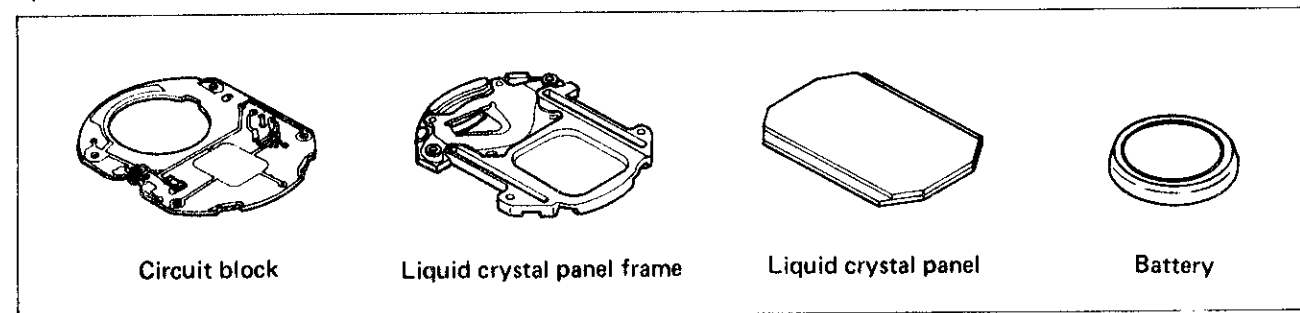

- Only the conductive portions should be wiped with a cloth moistened with benzine or alcohol and dried with cool air. (Wipe any stains on the battery with a dry cloth.)
- Use a brush to clean dust and lint.

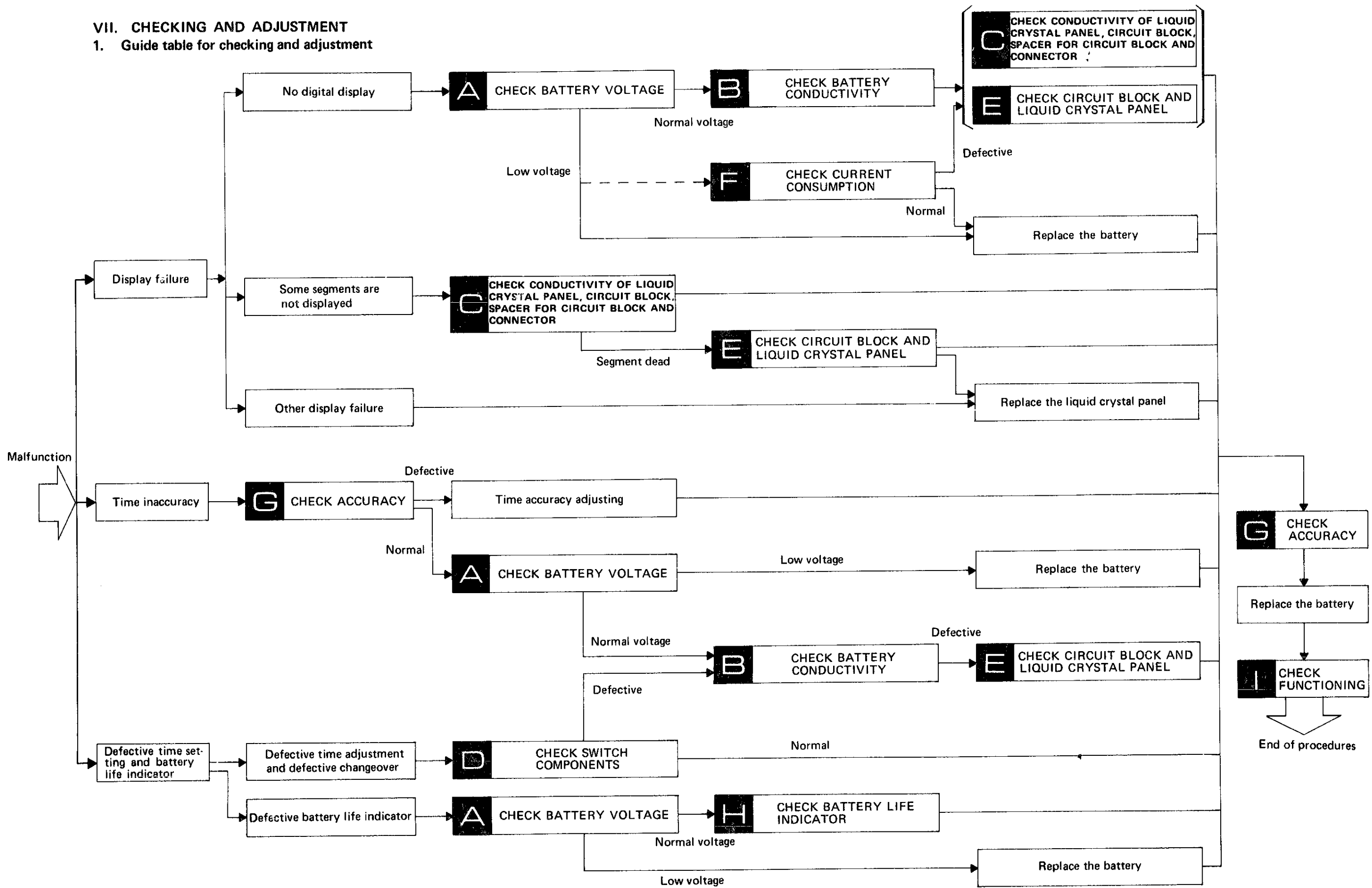

VII. CHECKING AND ADJUSTMENT
1. Guide table for checking and adjustment



Note: If it is difficult to locate the malfunctioning portion, proceed to **I CHECK FUNCTIONING** first.

2. Malfunction and checking points

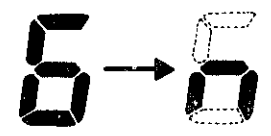
- Check in numerical order.
- Refer to "Procedures for checking and adjustment" on the following pages.

FAULTY SYMPTOMS		CHECKING POINTS								
		A	B	C			D	E	F	
		Battery voltage	Battery conductivity	Liquid crystal panel	Circuit block	Spacer for circuit block	Connector	Switch components	Circuit block, liquid crystal panel	Battery life indicator
DISPLAY FAILURE	Digits are displayed, but second dots do not flash.	①	②						③	
	No digital display, dim digital display or extremely slow response. 	①	②	③	⑤	⑥	④		⑦	
	Some segments of the digital figures are not lighted or dim. 			②	③		①			
	All segments are lighted. 			②	③		①			
	Some portions of the liquid crystal panel will make black dots or iridescent circles.			①						
TIME INACCURACY	Gain or loss tested by Quartz Tester	①	②							
	Though Quartz Tester indicates the normal accuracy, a watch gains or loses when it is worn on the wrist.	①	②						③	
DEFECTIVE TIME AND CALENDAR SETTING	Failure of time and calendar setting. The display extinguishes while the time and calendar digits are being set, or the changeover of the display cannot be made.							①	②	
	All digits are flashing.	①								②

3. Procedures for checking and adjustment

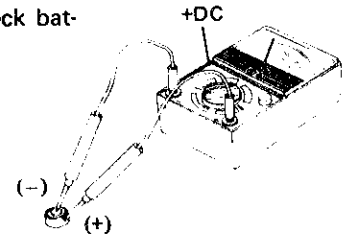
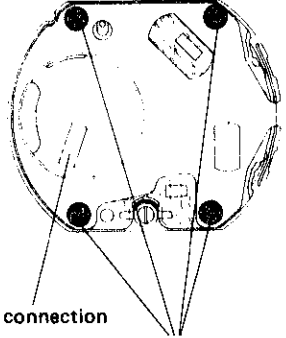
	Procedure	Result
CHECK BATTERY VOLTAGE	<p>Use the following procedures to check battery voltage.</p>  <ul style="list-style-type: none"> • Set up the volt-ohm-meter Range to be used: DC 3V • Measuring Probe Red (+) Battery surface (+) Probe Black (-) Battery surface (-) 	<p>More than 1.5 V → Normal Less than 1.5 V → Defective Replace the battery with a new one.</p>
CHECK BATTERY CONDUCTIVITY	<p>First check Check for any contamination on the battery and the battery connection.</p>  <p>Second check Make sure that the screws for circuit block cover are tightened firmly.</p> <p>Third check Check to see if there is battery electrolyte leakage.</p> <ul style="list-style-type: none"> • How to repair battery electrolyte leakage <ol style="list-style-type: none"> 1. Remove the module from the case. 2. Disassemble the module. 3. Clean the parts contaminated with battery electrolyte. <ul style="list-style-type: none"> • Clean the circuit block <ol style="list-style-type: none"> (1) Wipe off battery electrolyte on the circuit block with a cloth moistened with distilled water (or normal tap water) first and then with a cloth moistened with alcohol. <p>Note:</p> <ul style="list-style-type: none"> • Do not use a cloth which gives off lint such as gauze, flannel, etc. • Be careful that the trimmer condenser is not exposed to water or alcohol. <ol style="list-style-type: none"> (2) Dry with cool air by using a dryer. <ul style="list-style-type: none"> • Clean the other parts <ol style="list-style-type: none"> (1) Wipe off battery electrolyte on the other parts with a soft brush moistened with distilled water (or normal tap water). (2) Dry with cool air by using a dryer. Reassemble after making sure that the parts are thoroughly dry. <ol style="list-style-type: none"> 4. Reassemble the module and replace the battery with a new one. 5. Check to see if the time setting functions and the current consumption are normal. 	<p>Uncontaminated → Normal Contaminated → Defective Wipe off any foreign matter.</p> <p>No loosened screws → Normal Loosened screws → Defective Retighten screws.</p> <p>No battery electrolyte leakage → Normal Battery electrolyte leakage → Defective Wipe off battery electrolyte by following the repairing procedure.</p>

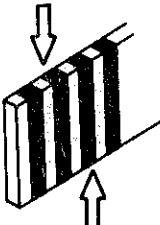
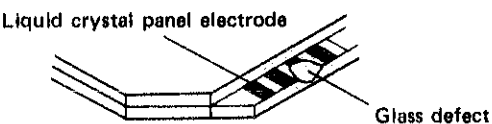
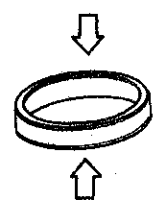
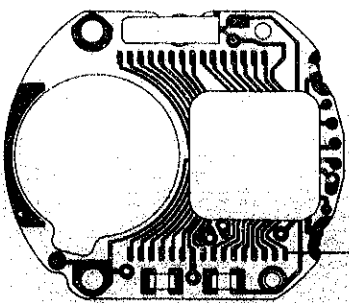
Procedure	Result
<p>C</p> <p>First check Check for any contamination, crack and tiny break of the connector.</p>  <p>Check carefully the connecting portions of the liquid crystal panel and the circuit block.</p>	<p>No contamination, crack or tiny break → Normal</p> <p>Contaminated → Defective Wipe off any foreign matter.</p> <p>Crack or tiny break → Defective Replace the connector with a new one.</p>
<p>Second check Check the liquid crystal panel electrode (connecting portion of the connector) for any foreign matter and glass defects.</p>  <p>Liquid crystal panel electrode</p> <p>Glass defect</p>	<p>No contamination or glass defect → Normal</p> <p>Contaminated → Defective Wipe off any foreign matter.</p> <p>Glass defect → Defective Replace the liquid crystal panel with a new one.</p>
<p>Third check Check for any contamination of the spacer for circuit block.</p> <p>Check carefully the connecting portions of the circuit block and the battery connection.</p> 	<p>Uncontaminated → Normal</p> <p>Contaminated → Defective Wipe off any foreign matter.</p>
<p>Fourth check Check the circuit block electrode (connecting portion of the connector) for any foreign matter.</p>  <p>Circuit block electrode</p>	<p>Uncontaminated → Normal</p> <p>Contaminated → Defective Wipe off any foreign matter.</p>

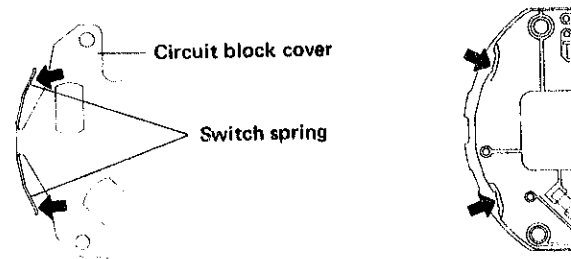
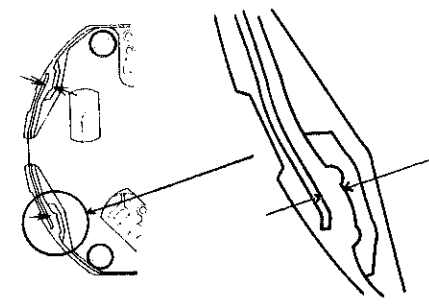
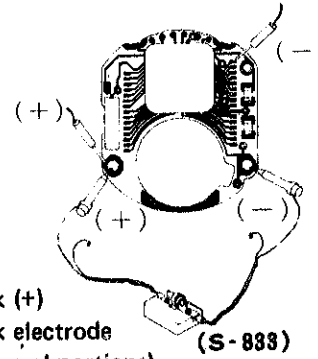
Procedure	Result
<p>D</p> <p>First check Check for any contamination on the switch spring of the circuit block cover and the circuit block (connecting portion of the switch spring).</p>  <p>Circuit block cover</p> <p>Switch spring</p> <p>Second check Check for clearance between the circuit block cover and the circuit block. (Check after the circuit block cover is reassembled.)</p> 	<p>Uncontaminated → Normal</p> <p>Contaminated → Defective Wipe off any foreign matter.</p> <p>Clearance → Normal</p> <p>No clearance → Defective Correct the switch spring with tweezers so that there is a clearance.</p>
<p>E</p> <p>First check Check to see if the electric signal flows into the connector from the circuit block correctly.</p> <ol style="list-style-type: none"> Supply voltage power (1.5 V) to the circuit block by using the electricity supplier. Set up the electricity supplier (S-833). Set up the Volt-ohm-meter. Range to be used: DC3V Measuring Probe Red (+) . . . Circuit block (+) Probe Black (-) . . . Circuit block electrode (Apply to several portions)  <p>(S-833)</p> <p>Second check Check for any broken panel pattern, short circuit, etc. of the liquid crystal panel.</p> <ol style="list-style-type: none"> Set up the volt-ohm-meter (Any range will do if more than 3 V is applied to the terminal of the volt-ohm-meter.) Range to be used: OHMS R X 1 Disassemble the liquid crystal panel from the module and turn the liquid crystal panel upside down. 	<p>More than 0.8 V → Normal</p> <p>Less than 0.8 V → Defective Replace the circuit block with a new one.</p> <p>The above voltage is obtained when measured by either the volt-ohm-meter S-831 (or AF-105) mentioned in the Technical Guide or a volt-ohm-meter whose internal resistance is higher than that of the S-831 (or AF-105).</p>

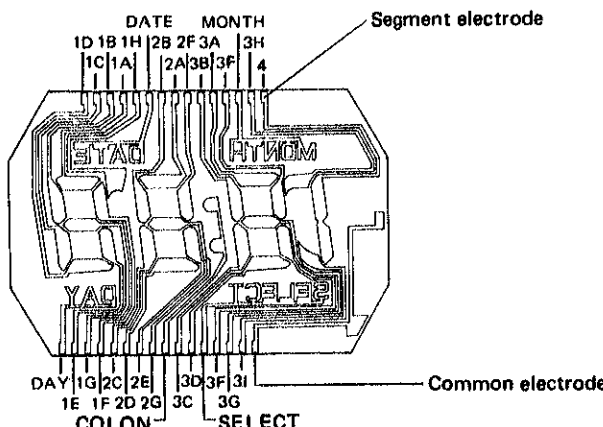
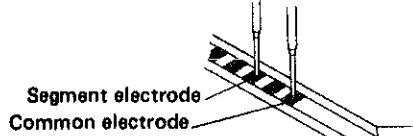
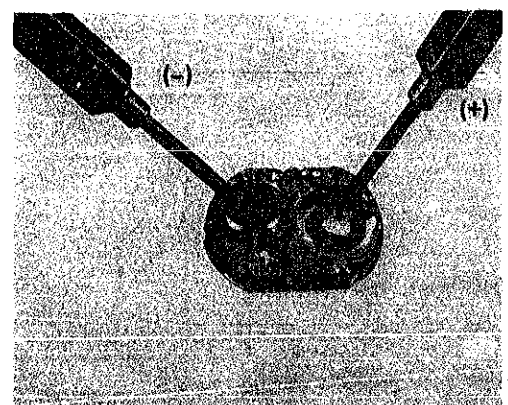
	Procedure	Result
CHECK CIRCUIT BLOCK AND LIQUID CRYSTAL PANEL	<p>(3) Measuring Apply the red and black probes of the volt-ohm-meter to the common electrode and the segment electrode of the liquid crystal panel. (Either red or black probe will do.)</p>  	<p>Light up → Normal Do not light up → Defective Replace the liquid crystal panel with a new one.</p>
CHECK CURRENT CONSUMPTION	<p>Check to see if the current consumption is normal.</p> <p>(1) Set up the volt-ohm-meter Range to be used: DC 12μA (DC 0.03mA AF 105)</p> <p>(2) Place the battery on the circuit block cover with its (-) surface up.</p> <p>(3) Measuring Probe Red (+) Battery connection Probe Black (-) Battery surface (-)</p> 	<p>Less than 2.0 μA → Normal More than 2.0 μA → Defective Proceed to [] and [].</p>

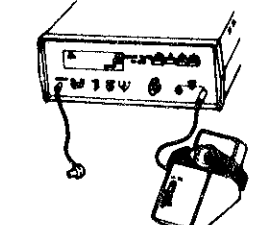
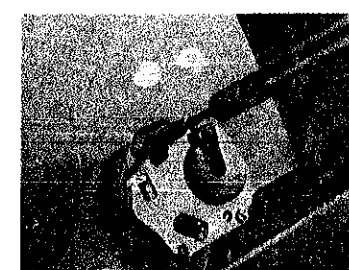
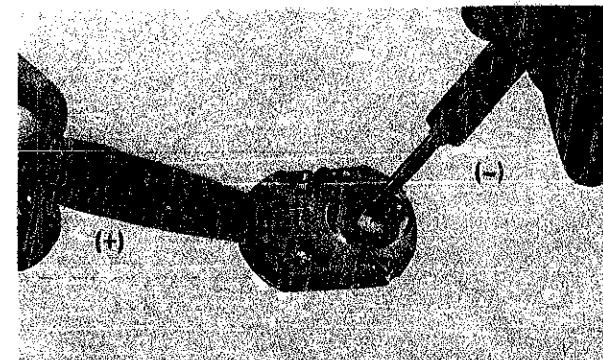
	Procedure	Result
CHECK ACCURACY	<p>Check gain and loss of time.</p> <p>Set up the Quartz Tester.</p> <p>Set the microphone switch (Electro-magnetic and Electric-field detection Changeover-Power switch) to LC ON position.</p>  <ul style="list-style-type: none"> How to adjust time accuracy The watch will gain or lose according to the direction in which the trimmer condenser is turned.  <p>Adjustment should therefore be made after ascertaining with the Quartz Tester whether the watch tends to gain or lose.</p> <p>Note for handling the trimmer condenser Avoid excessive depressing and turning of the trimmer condenser.</p>	
CHECK BATTERY LIFE INDICATOR	<p>Check to see if the battery life indicator functions correctly.</p> <p>First check</p> <p>(1) Set up the Micro Test. Set the voltage at 1.1 V.</p> <p>(2) Apply the terminals of the Micro Test to the module. Red Clip (+) . . . Circuit block cover with switch spring. Black Probe (-) . . . Battery connection</p> 	<p>Display flashes → Normal Display does not flash → Defective Replace the circuit block with a new one.</p>

	Procedure	Result
CHECK BATTERY LIFE INDICATOR	<p>Second check</p> <p>(1) Set up the Micro Test Set the voltage at 1.5 V.</p> <p>(2) Apply the terminals of the Micro Test to the module in the same way as in First check (2).</p>	<p>Display does not flash → Normal</p> <p>Display flashes → Defective Replace the circuit block with a new one.</p>

Check to see if display changeover and adjustment function correctly by button operation.

First check

Check to see if the time display, calendar display and second display are changed into the desired display by depressing button "A". (Check to see if the second display is changed into the time display automatically 4 to 5 minutes after button "A" is depressed when the second digits are displayed.)

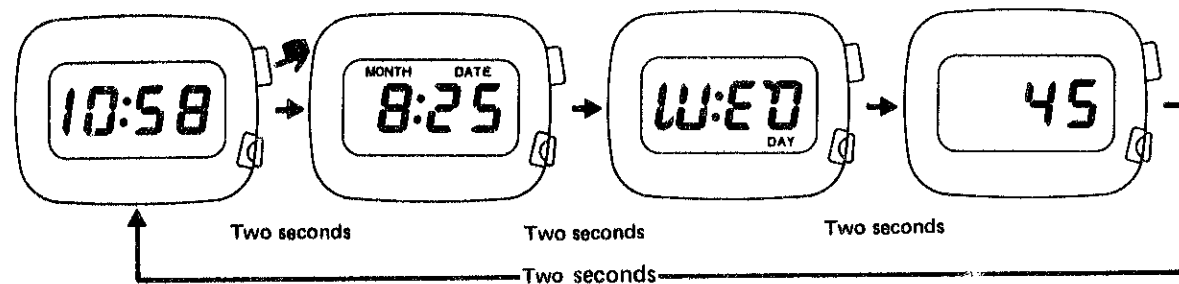

Second check

Check to see if each digit is selected and set by depressing buttons "A" and "B".

(Make sure that there is no dead segment.)

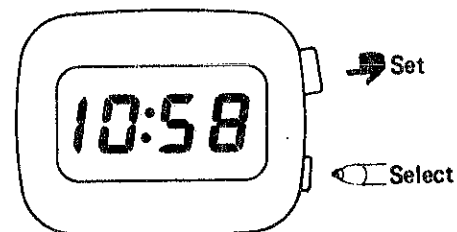

All procedures of Disassembling, Reassembling, Checking and Adjustment are completed.

CHECK FUNCTIONING