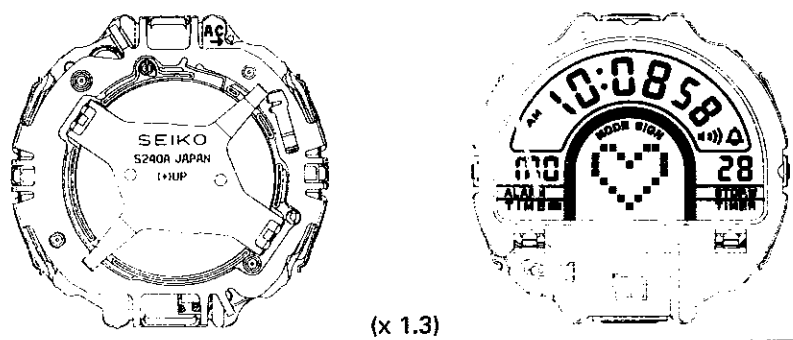

PARTS CATALOGUE / TECHNICAL GUIDE

Cal. S240A

[SPECIFICATIONS]

		Cal. No.	S240A
Item			
Module		 <p style="text-align: right;">(x 1.3)</p>	
Module size	Outside diameter	ø32.0mm	
	Casing diameter	-	
	Height	6.8mm	
Display medium		Nematic Liquid Crystal, FEM (Field Effect Mode)	
Liquid crystal driving system		Multiplex driving system	
Display system		<ul style="list-style-type: none"> • Time/calendar display <ul style="list-style-type: none"> • Hour, minutes, seconds, date, day, AM/PM mark, 12- or 24-hour indication and automatic calendar • Stopwatch display <ul style="list-style-type: none"> • Up to 100 hours • In minutes, seconds and 1/100 seconds for the first 60 minutes and in hours, minutes and seconds thereafter • Lap time measurement/lap No. display/lap time memory (30 lap times) • Timer display <ul style="list-style-type: none"> • 60 minutes countdown timer (Up to 60 minutes can be set in minutes.) • No. of times the countdown is repeated • Alarm display <ul style="list-style-type: none"> • Can be set on a 24-hour basis • Pulsemeter display <ul style="list-style-type: none"> • Pulse rate (From 30 to 210 beats per minute) • Physical exercise intensity 	
Additional mechanism		<ul style="list-style-type: none"> • Illuminating light • Confirmation sound for watch operation • Battery life indicator • Demonstration of displays 	
Loss/gain		Monthly rate at normal temperature range: less than 20 seconds	
Regulation system		Nil	
Measuring gate by quartz tester		Any gate can be used.	
Battery		Matsushita CR2025 Battery life is approximately 2 years Voltage: 3.0V	

PARTS CATALOGUE

Cal. S240A

Disassembling procedures Figs. : ① → ⑮
 Reassembling procedures Figs. : ⑮ → ①
Lubricating: Types of oil **Oil quantity**
 ● Silicone oil 500,000 c.s. ● Normal quantity

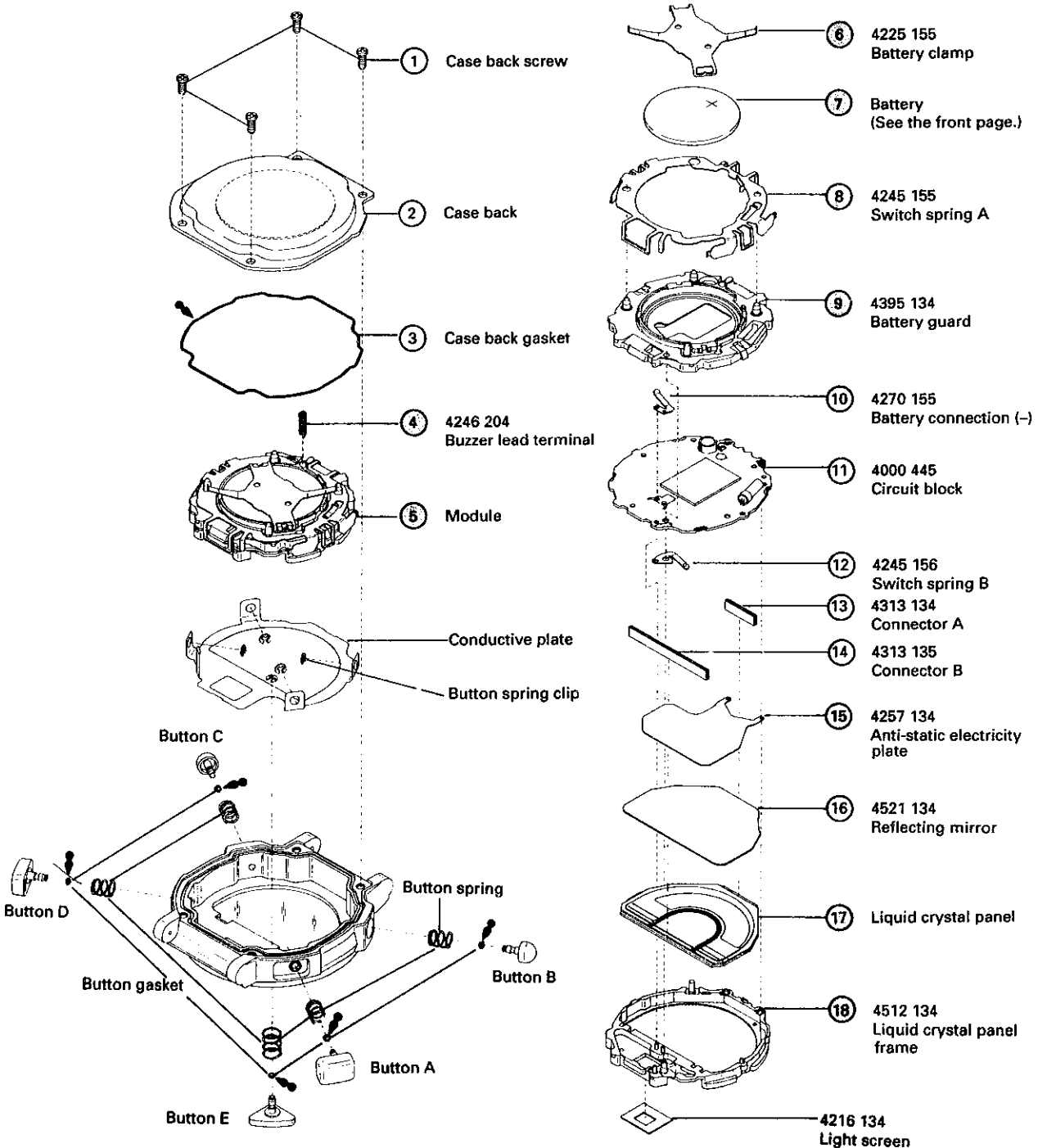

*** Note:** Do not disassemble the buttons and conductive plate except when they need to be replaced.

○ ➡ Please see the remarks on the following pages.

PARTS CATALOGUE

Cal. S240A

Remarks:

- ⑰ Liquid crystal panel 4510 134 (Red), 4510 135 (Blue)

The type of liquid crystal panel is determined based on the design of cases.
Refer to "SEIKO Casing Parts Catalogue" to choose a corresponding liquid crystal panel.

- Other parts
 - Bulb 4530 200
The bulb is available for supply separately from the circuit block, though they are soldered together.
 - Piezoelectric element 4589 003
 - Light screen 4216 134
Do not remove the light screen except when it needs to be replaced.

TECHNICAL GUIDE

Cal. S240A

- The explanation here is only for the particular points of Cal. S240A.
- For the repairing, checking and measuring procedures, refer to the "TECHNICAL GUIDE, GENERAL INSTRUCTIONS".

I. STRUCTURE OF THE CIRCUIT BLOCK

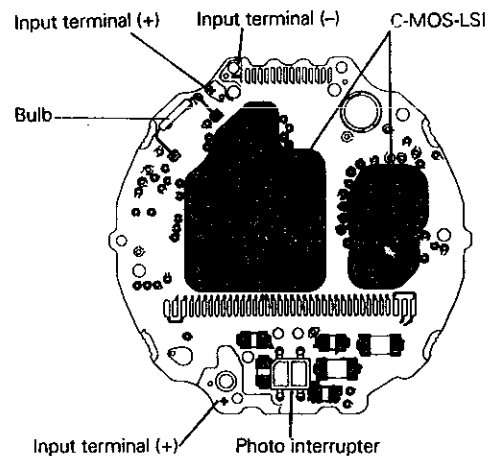
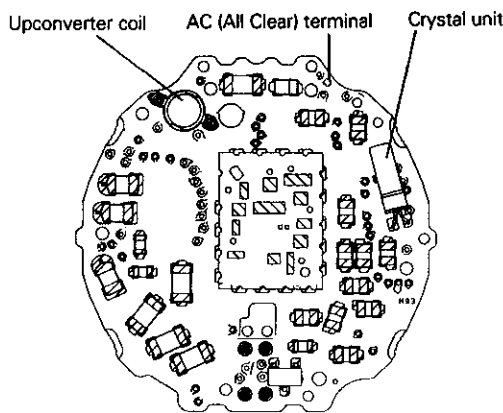

II. RELATIONSHIP BETWEEN THE SEGMENT (LIQUID CRYSTAL PANEL ELECTRODE) AND THE C-MOS-LSI OUTPUT TERMINAL

- Designation of the segment

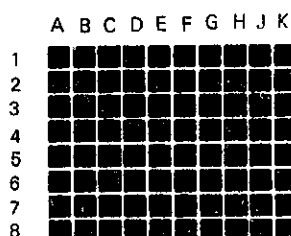
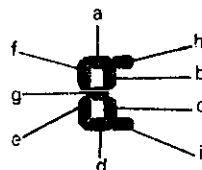

Enlarged

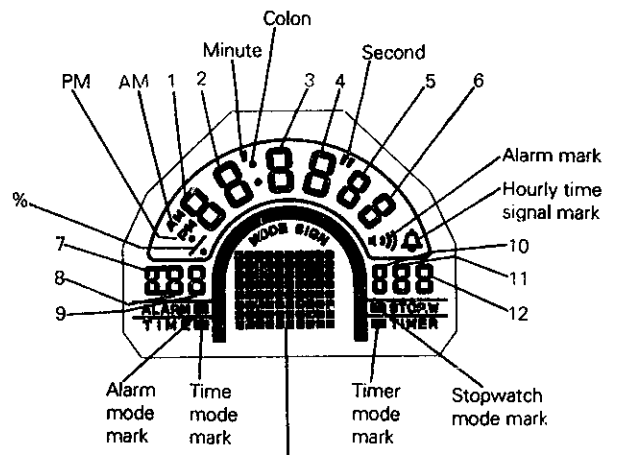

TECHNICAL GUIDE

Cal. S240A

• Segment (Liquid crystal panel electrode)

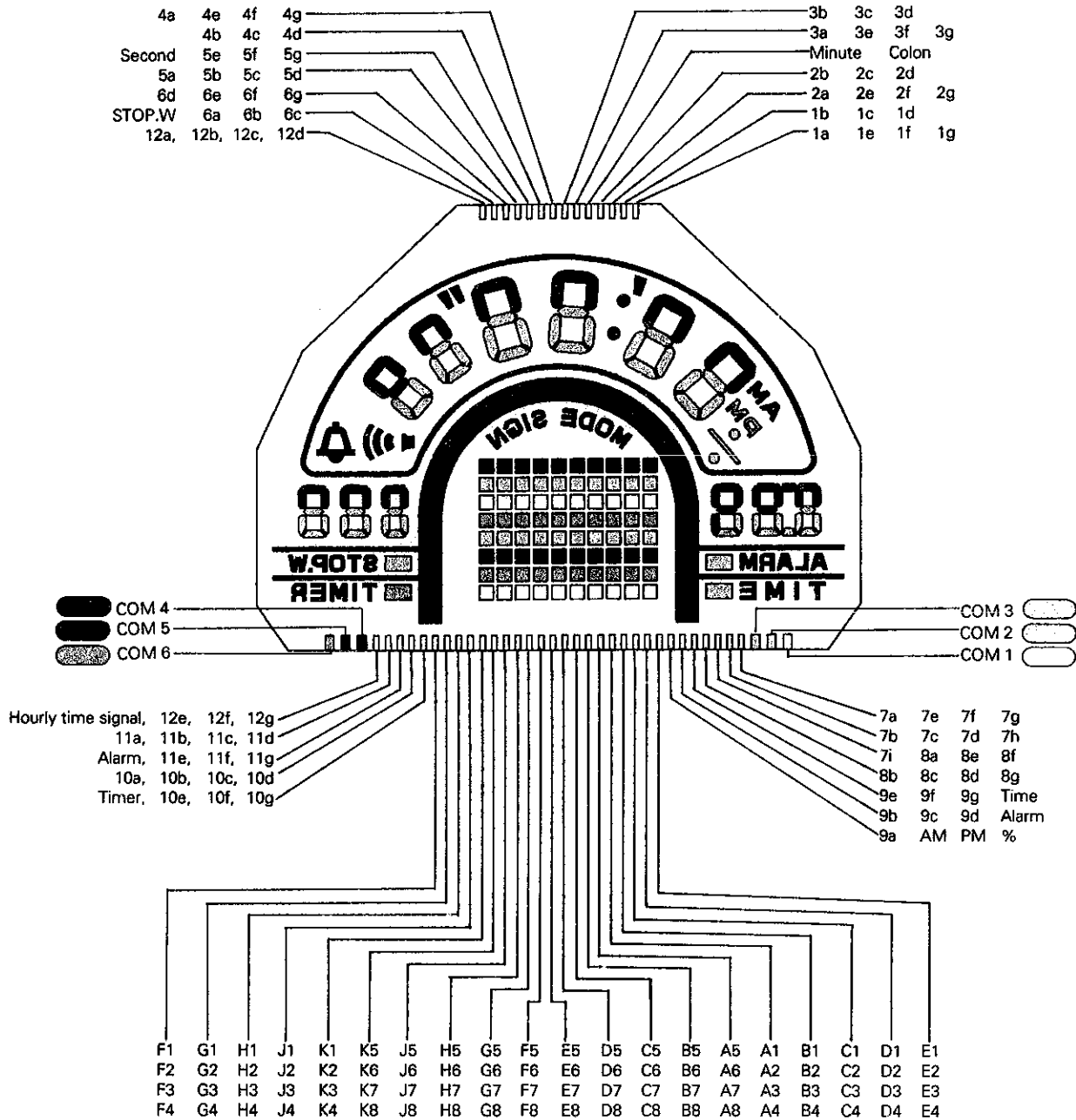

TECHNICAL GUIDE

Cal. S240A

• C-MOS-LSI output terminal

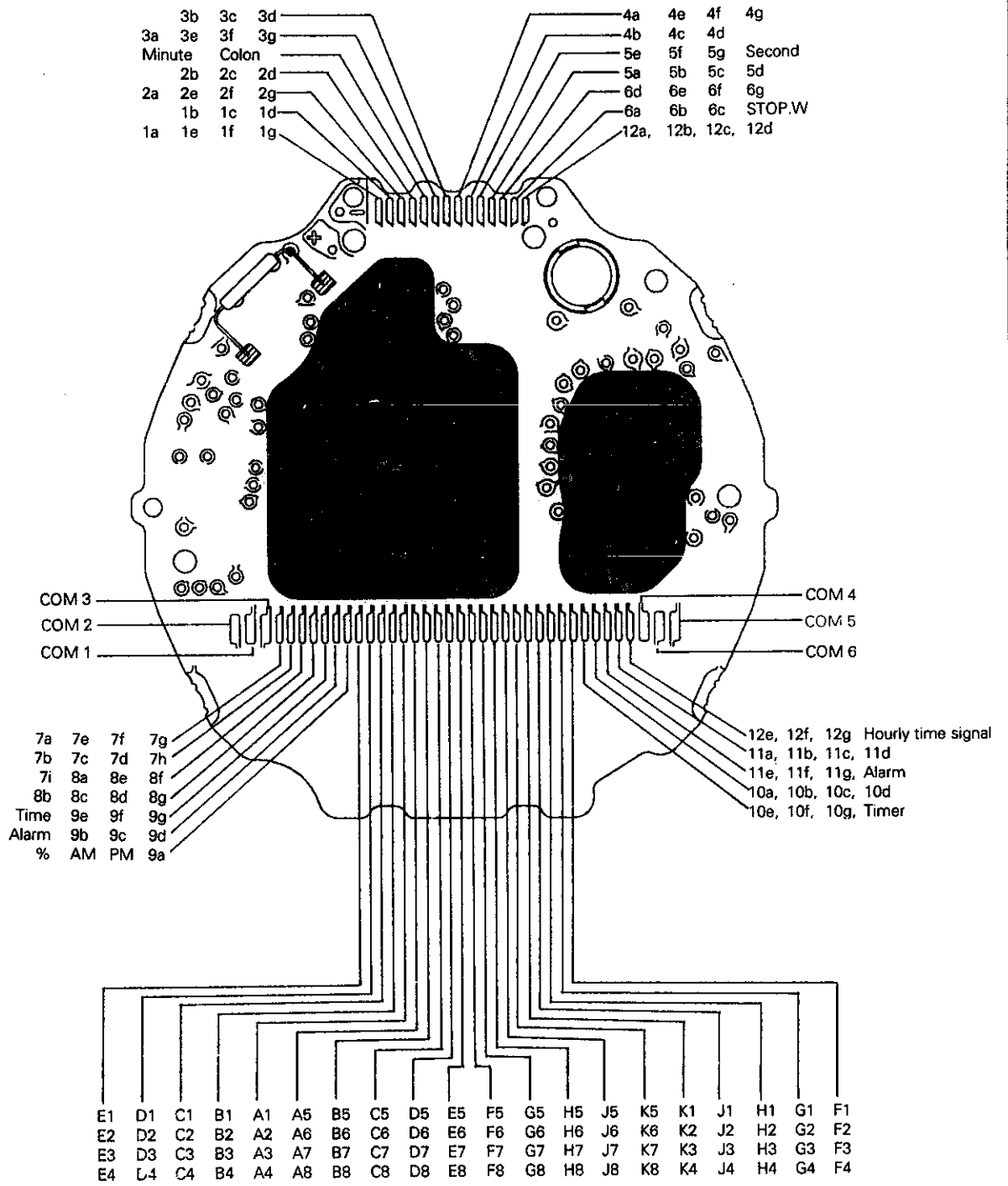

III. REMARKS ON INSTALLING THE BATTERY

- After the battery is replaced with a new one, or after the battery is re-installed following the repairing procedures, be sure to short-circuit the AC terminal of the circuit block and the switch spring A with conductive tweezers as illustrated to reset the circuit.

Note: When measuring the current consumption, make sure that the power is supplied externally before resetting the circuit.

- To reset the circuit with the case back installed, keep buttons A, B, C and D pressed for 2 to 3 seconds. "12:0000 AM SU 1" will be shown on the display.

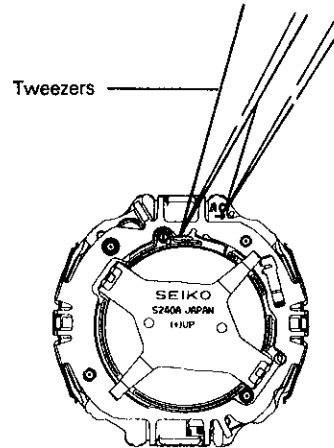

IV. REMARKS ON DISASSEMBLING AND REASSEMBLING

④ Buzzer lead terminal

• How to remove

Turn the buzzer lead terminal to release its end portion from the groove of the battery guard, then remove it.

• How to install

Set the end portion of the buzzer lead terminal into the groove of the battery guard, then turn it to fix it.

Buzzer lead terminal

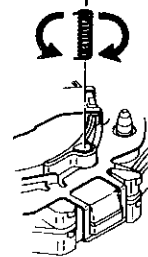

⑤ Module

When handling the module with the parts installed on it, take care not to apply undue force to the photo interrupter.

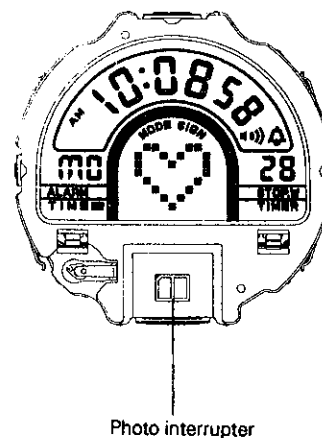

⑥ Battery clamp

• How to remove

Pry up with the tip of the tweezers the two protrusions of the battery clamp hooked to the notches of the battery guard.

• Checking after installation

After installing the battery clamp, check that the battery guard is securely caught by the two protrusions of the battery clamp.

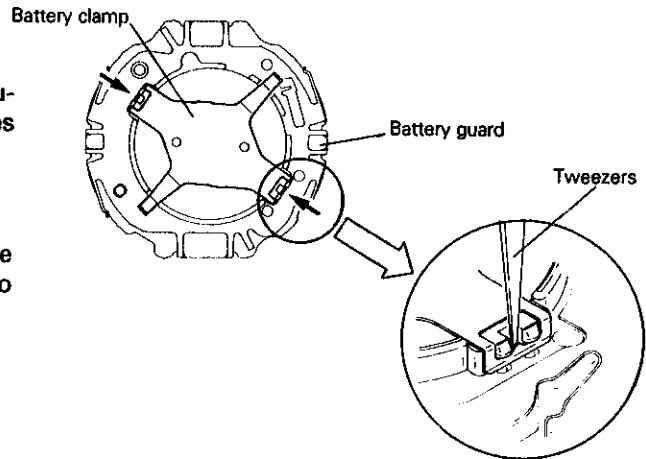

⑦ Battery

• How to install

Install the battery sideways as shown in the illustration lest it should press down the contact portion of the switch spring A.

Set the battery sideways.

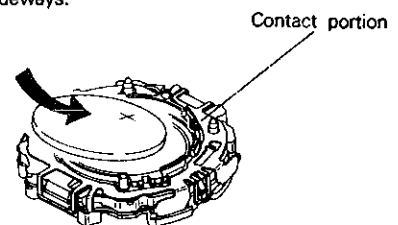

⑧ Switch spring A

• How to remove

Pry up the four hooking portions of the switch spring A with the tip of the screwdriver to remove it.

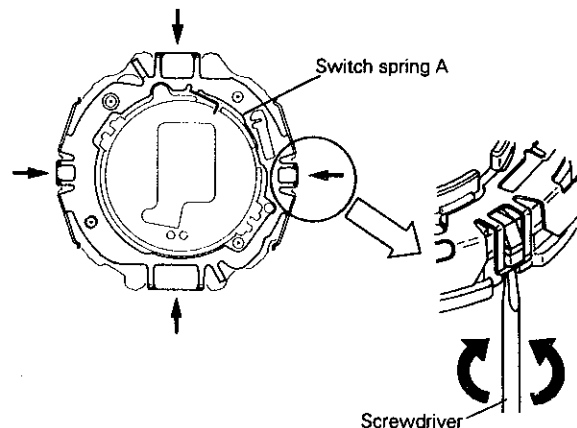

⑨ Battery guard

• How to remove

The battery guard is fixed to the liquid crystal panel frame by means of interference between the guide pins of the liquid crystal panel frame and the guide holes of the battery guard. To remove the battery guard, insert the tip of the screwdriver into the two notched portions near the guide pins of the liquid crystal panel frame as indicated by the arrows in the illustration, and lightly pry up the battery guard. In doing so, take care not to damage the battery guard, as it is made of plastics.

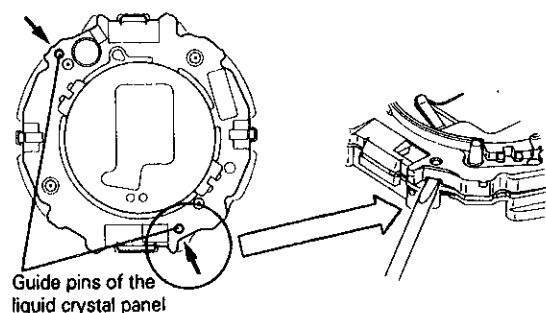

⑮ Anti-static electricity plate

Take care not to set the anti-static electricity plate up side down.

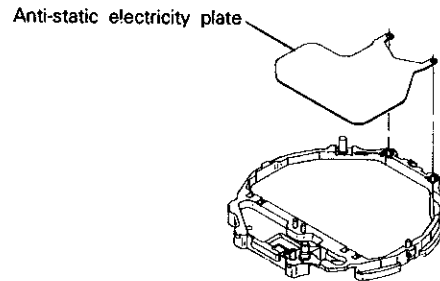

⑰ Liquid crystal panel frame

- Assembling and disassembling of the module should be made with the light screen installed in the liquid crystal panel frame.
- After the whole parts are installed on the module, check that the light screen and the photo interrupter are set in position.
- If the photo interrupter is covered by the light screen, or if there is any opening between the light screen and the photo interrupter, remove the light screen and adhere it again to the liquid crystal panel frame.

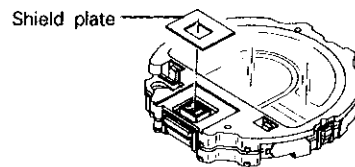

• Remarks on installing the module to the case

When closing the case back, check that the conductive plate is placed in position within the case.

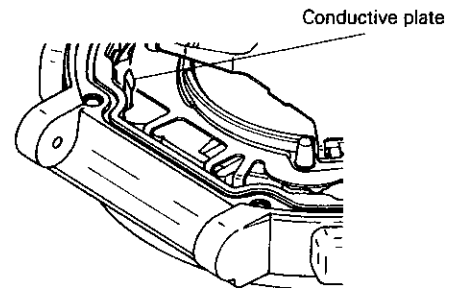

V. VALUE CHECKING

• Time accuracy

To measure accuracy, light up all the segments of the display. To do so, keep buttons C and D pressed at the same time for 2 to 3 seconds in the TIME/CALENDAR SETTING display. After the measurement, press button A, B, C, D or E to return to the TIME/CALENDAR display.

• Upconverter coil resistance

120Ω ~ 180Ω

• Current consumption

For the whole of the module: less than 5.5μA

Note: Before measuring the current consumption, be sure to reset the circuit. (Refer to the "REMARKS ON INSTALLING THE BATTERY".) Otherwise, all the segments will light up or the display will be disordered, and as a result, current consumption cannot be measured correctly.

- **Notes on measuring the pulse rate**

- * Be sure to measure your pulse rate while you are lying at rest. If you move your body or even your fingers, the pulse rate changes and an accurate measurement cannot be obtained.
- * To measure your pulse rate, put your finger pad not your fingertip lightly on the sensor so that it is completely covered by your finger pad. Otherwise, correct measurement cannot be obtained.
- * If the watch is left in very low temperature for a long time, or your fingers are too cold or rough, the sensor may not sense your blood flow.