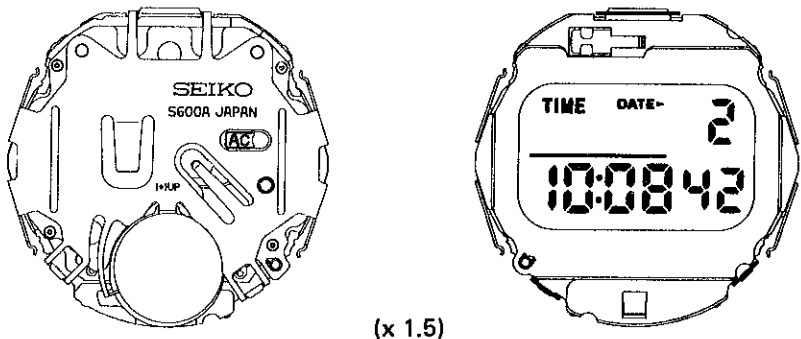

PARTS CATALOGUE/TECHNICAL GUIDE

Cal. S600A

[SPECIFICATIONS]

Cal. No.		S600A	
Item			
Module			
Module size	Outside diameter	φ28mm	
	Casing diameter	—	
	Height	4.3mm	
Display medium		Nematic Liquid Crystal, FEM (Field Effect Mode)	
Liquid crystal driving system		Multiplex driving system	
Display system		<ul style="list-style-type: none"> • Time/calendar display (12-hour indication) • Stopwatch display <ul style="list-style-type: none"> • Accumulated elapsed time measurement : Up to 100 hours in 1/100 seconds • Lap time measurement : Hour, minutes and seconds • Lap No. display : 100 laps from "01" to "00" • Lap time memory : 10 lap times 	
Additional mechanism		<ul style="list-style-type: none"> • Illuminating light 	
Loss/gain		Monthly rate at normal temperature range: less than 20 seconds	
Regulation system		Nil	
Measuring gate by quartz tester		Any gate can be used.	
Battery		SEIKO SR927W, Maxell SR927W, SONY SR927W, EVEREADY 399 Battery life is approximately 3 years. Voltage: 1.55V	

HATTORI SEIKO CO., LTD.

PARTS CATALOGUE

Cal. S600A

Disassembling procedures Figs.: ① → ⑮

Reassembling procedures Figs.: ⑮ → ①

Lubricating: Types of oil Oil quantity

∞ Silicone oil 500,000 cs ∞ Normal quantity

○ → Please see the remarks on the following pages.

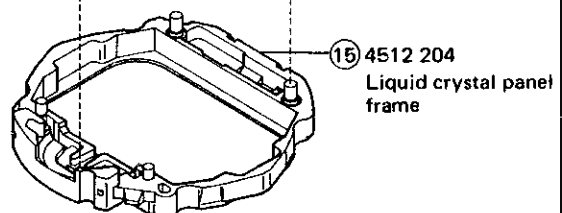
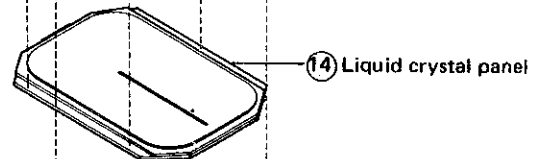
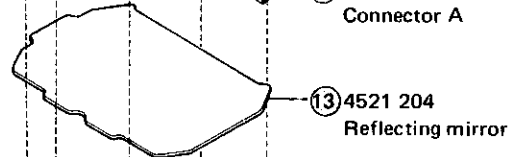
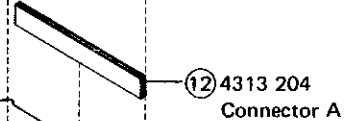
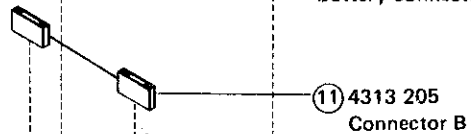
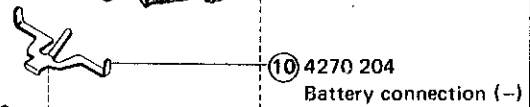
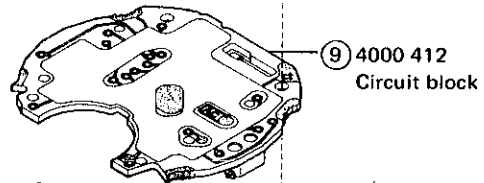
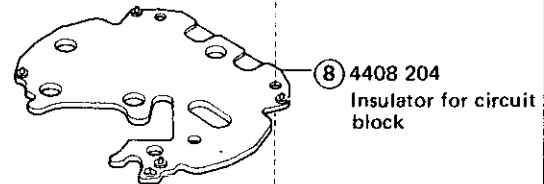
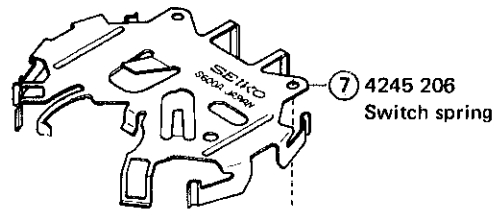
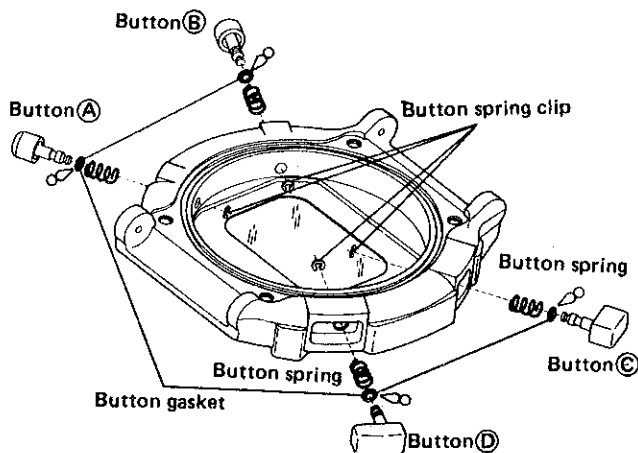
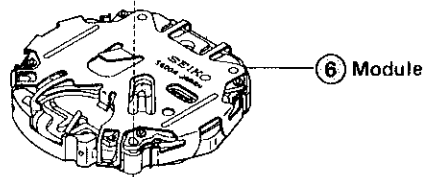
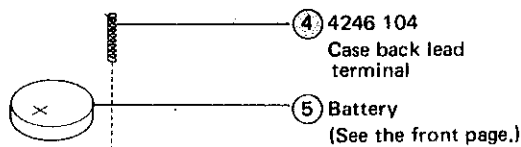
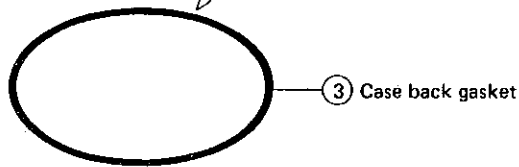
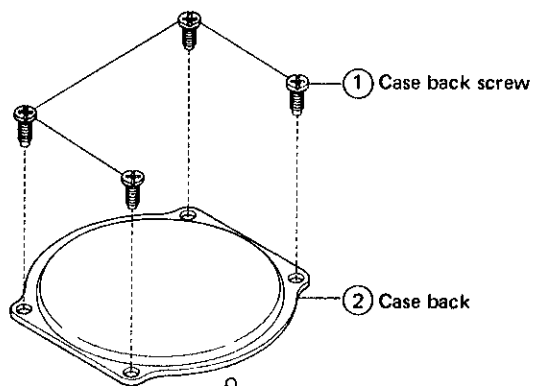

* Do not disassemble the buttons except when they need to be replaced.

Remarks:

- ⑭ Liquid crystal panel 4510 096 (Gold), 4510 204 (Silver)

The type of the liquid crystal panel is determined based on the cases. Refer to "SEIKO Casing Parts Catalogue" to choose a corresponding liquid crystal panel.

- Other parts

Bulb 4530 017

The bulb is soldered to the circuit block. However, it is available for supply separately from the circuit block.

- The explanation here is only for the particular points of Cal. S600A.
- For the repairing, checking and measuring procedures, refer to the "TECHNICAL GUIDE, GENERAL INSTRUCTIONS".

I. STRUCTURE OF THE CIRCUIT BLOCK

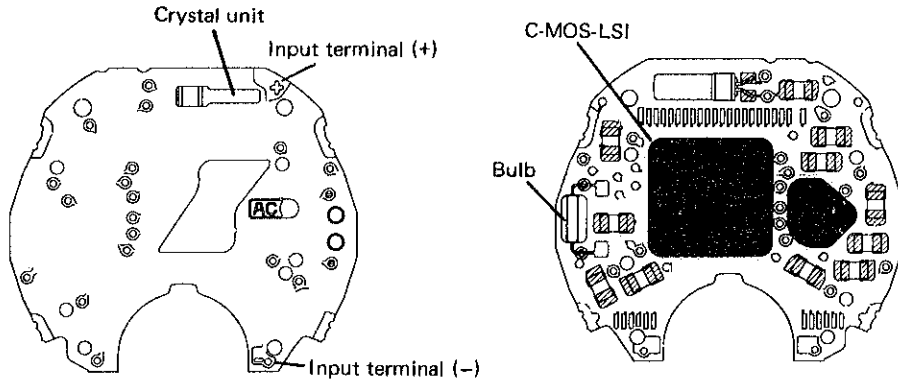

II. RELATIONSHIP BETWEEN THE SEGMENT (LIQUID CRYSTAL PANEL ELECTRODE) AND THE C-MOS-LSI OUTPUT TERMINAL

- Designation of the segment

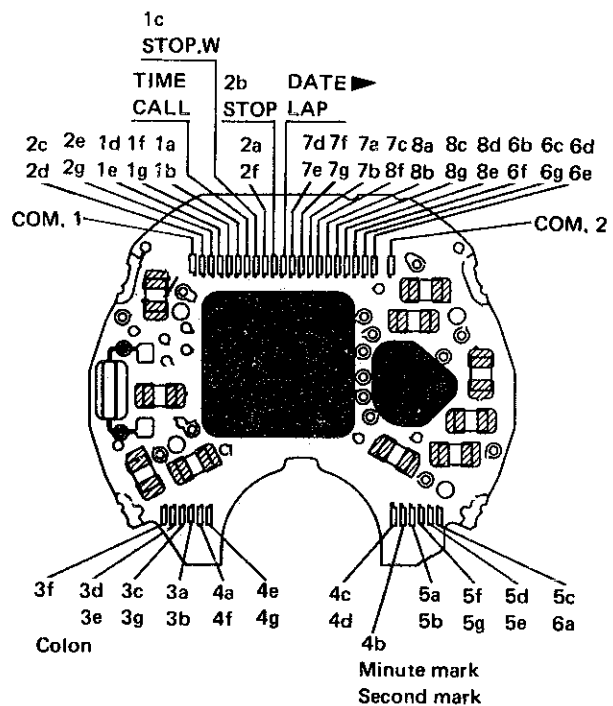
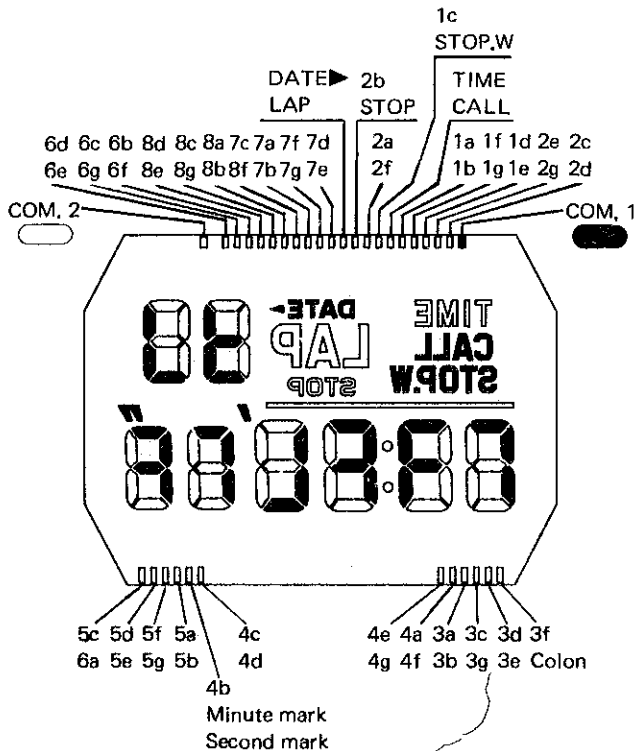
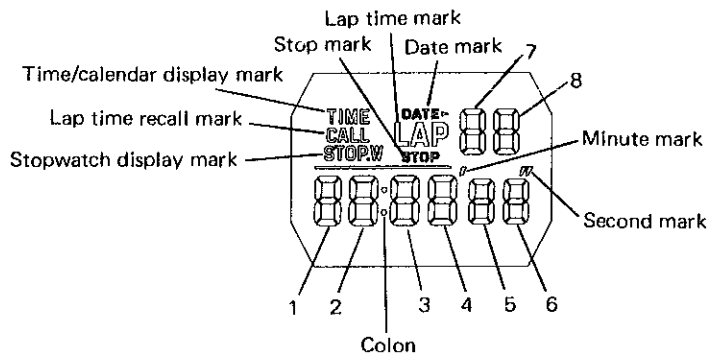
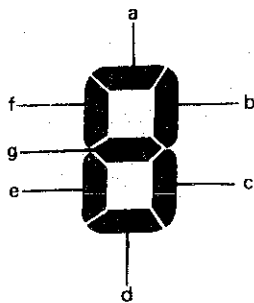

III. REMARKS ON INSTALLING THE BATTERY

After the battery is replaced with a new one, or after the battery is re-installed following the repairing procedures, be sure to short-circuit the AC terminal of the circuit block and the switch spring with conductive tweezers as illustrated at right to reset the circuit.

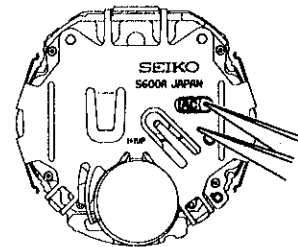

IV. REMARKS ON DISASSEMBLING AND REASSEMBLING

④ Case back lead terminal

● How to remove

Turn the case back lead terminal to release the straight portion of its end from the groove of the insulator for circuit block and remove it.

● How to install

Hook the straight portion at the end of the case back lead terminal to the groove of the insulator for circuit block, and then turn it to set it in position.

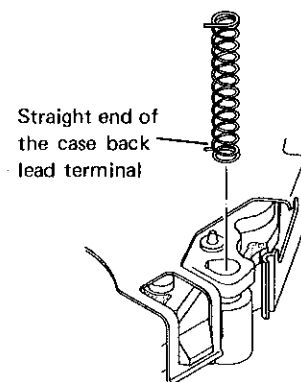

⑥ Module

When installing the module to the case, make sure that the partition line of the liquid crystal panel and the panel frame are not distorted.

In doing so, also check that the module is set in the proper position of the case. (Note that the battery is set at the 6 o'clock position.)

⑦ Switch spring

● How to remove

Pry up the switch spring lightly at the three hooking places by using the tip of a screwdriver.

● How to install

Set the guide holes of the switch spring to the guide pins of the liquid crystal panel frame located at 11 o'clock and 1 o'clock positions, and then set the three hooking places to the liquid crystal panel frame.

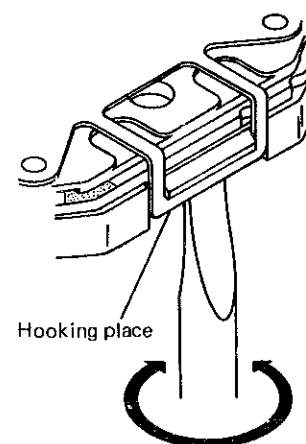

⑧ Insulator for circuit block

● How to remove

Pry up the insulator for circuit block lightly at the two recessed parts of the liquid crystal panel frame located near the two guide pins (at 11 o'clock and 1 o'clock positions) using the tip of a screwdriver.

Since the insulator for circuit block is made of plastics, take care not to apply undue force to it, as this will cause deform or scratches.

● How to install

The guide holes of the insulator for circuit block have some elasticity in the contact with the two guide pins of the liquid crystal panel frame located at 11 o'clock and 1 o'clock positions. Therefore, make sure that the insulator for circuit block is well seated on the liquid crystal panel frame when installing it.

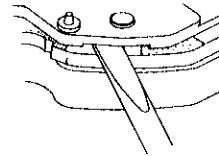
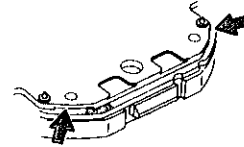

⑩ Battery connection (-)

● How to install

Insert the bent end of the battery connection (-) aslant into the notched part of the liquid crystal panel frame where the battery is to be installed. Then, securely set the battery connection (-) into the guide groove.

In doing so, make sure that the battery connection (-) is set in position.

If the battery is installed with the battery connection (-) outside the guide groove, short circuit may be caused.

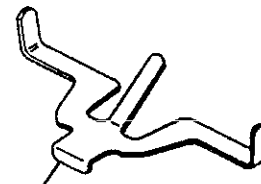

Bent end of the battery connection (-)

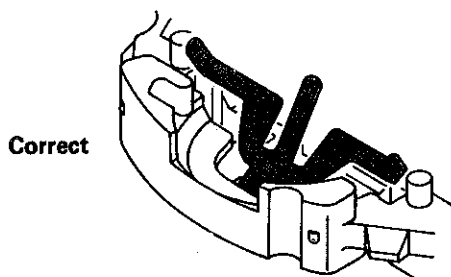

Correct

The battery connection (-) is properly set in the guide groove of the liquid crystal panel frame.

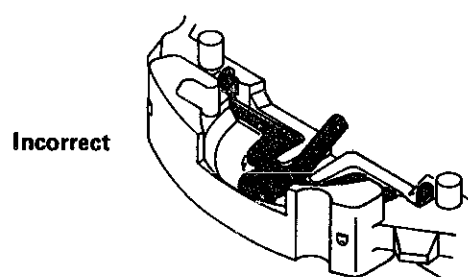

Incorrect

The bent end of the battery connection (-) has slipped out of the guide groove of the liquid crystal panel frame.

⑬ Reflecting mirror

● How to install

To install the reflecting mirror to the liquid crystal panel frame, set its two protrusions on the side of the guide groove for the battery connection (-) with its black surface up (facing to the circuit block).

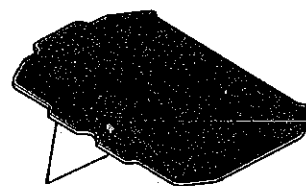

Protrusions (Set on the battery connection '(-)' side.)

⑭ Liquid crystal panel

● Setting position

Place the liquid crystal panel frame as shown in the illustration, and set the liquid crystal panel with its sealing part on the left-hand side and its partition line on the right-hand side.

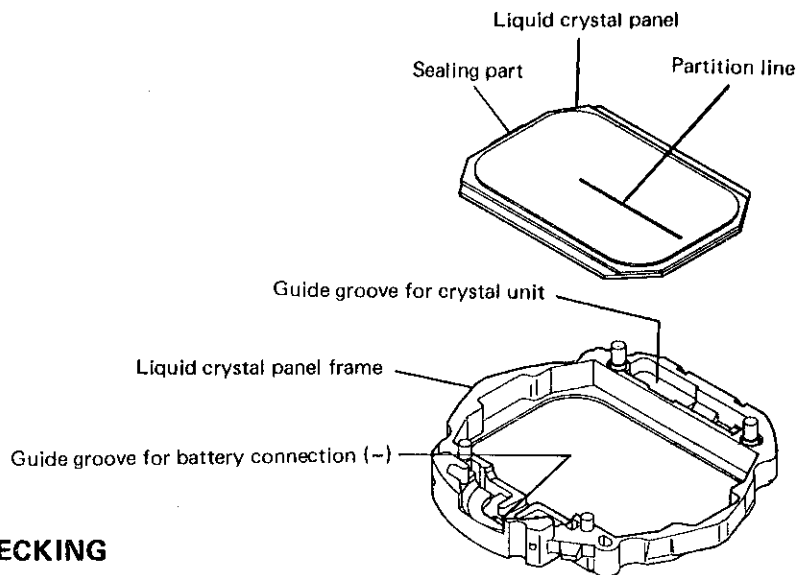

V. VALUE CHECKING

● Current consumption

For the whole of the module: less than $1.5\mu\text{A}$

Note: Before measuring current consumption, be sure to reset the circuit. Otherwise, all the segments will light up or the display will become disordered, and as a result, current consumption cannot be measured properly.