

# PARTS CATALOGUE/TECHNICAL GUIDE

## Cal. V051A

# PARTS CATALOGUE

Cal. V051A

### [SPECIFICATIONS]

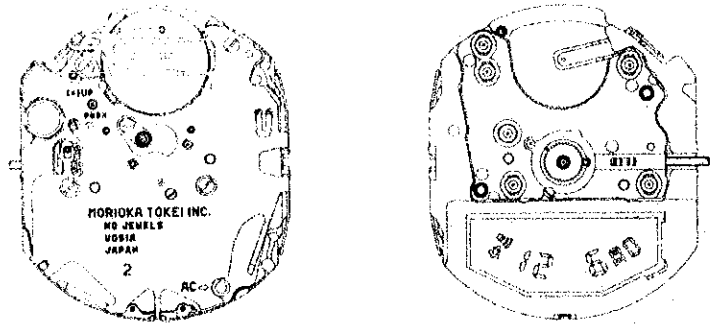
Item		Cal. No.	V051A
Movement			
Movement size	Outside diameter	28.5 mm between 6 o'clock and 12 o'clock sides 24.0 mm between 3 o'clock and 9 o'clock sides	
	Height	3.0 mm	
Time indication		Analogue section	Digital section
		3 hands	Nematic Liquid Crystal, FEM (Field Effect Mode)
Driving system		Step motor (Load compensated driving pulse type)	Multiplex driving system
Display system			<ul style="list-style-type: none"> <li>Calendar display (Month, date and day)</li> <li>Time display (Hour, minutes and seconds)</li> <li>Stopwatch display (Up to 60 minutes in 1/100 seconds)</li> <li>Alarm display (24-hour indication system; can be set in minutes.)</li> </ul>
Additional mechanism		<ul style="list-style-type: none"> <li>Electronic circuit reset switch</li> <li>Train wheel setting device</li> </ul>	<ul style="list-style-type: none"> <li>Hourly time signal</li> <li>Confirmation sound for watch operation</li> <li>Alarm test system</li> <li>Illuminating light</li> </ul>
Loss/gain		Monthly rate at normal temperature range: less than 20 seconds	
Regulation system		Nil	
Measuring gate by quartz tester		Any gate can be used (For analogue section)	
Battery		SEIKO SR920W, Maxell SR920W, SONY SR920W Battery life is approximately 2 years. Voltage: 1.55V	
Jewels		0 jewel	

Disassembling procedures Figs. : ① → ④②  
 Reassembling procedures Figs. : ④② → ①  
 Lubricating: Types of oil      Oil quantity  
 ● Moebius A      ○ Normal quantity  
 ○ Silicone Oil 500,000 c.s.

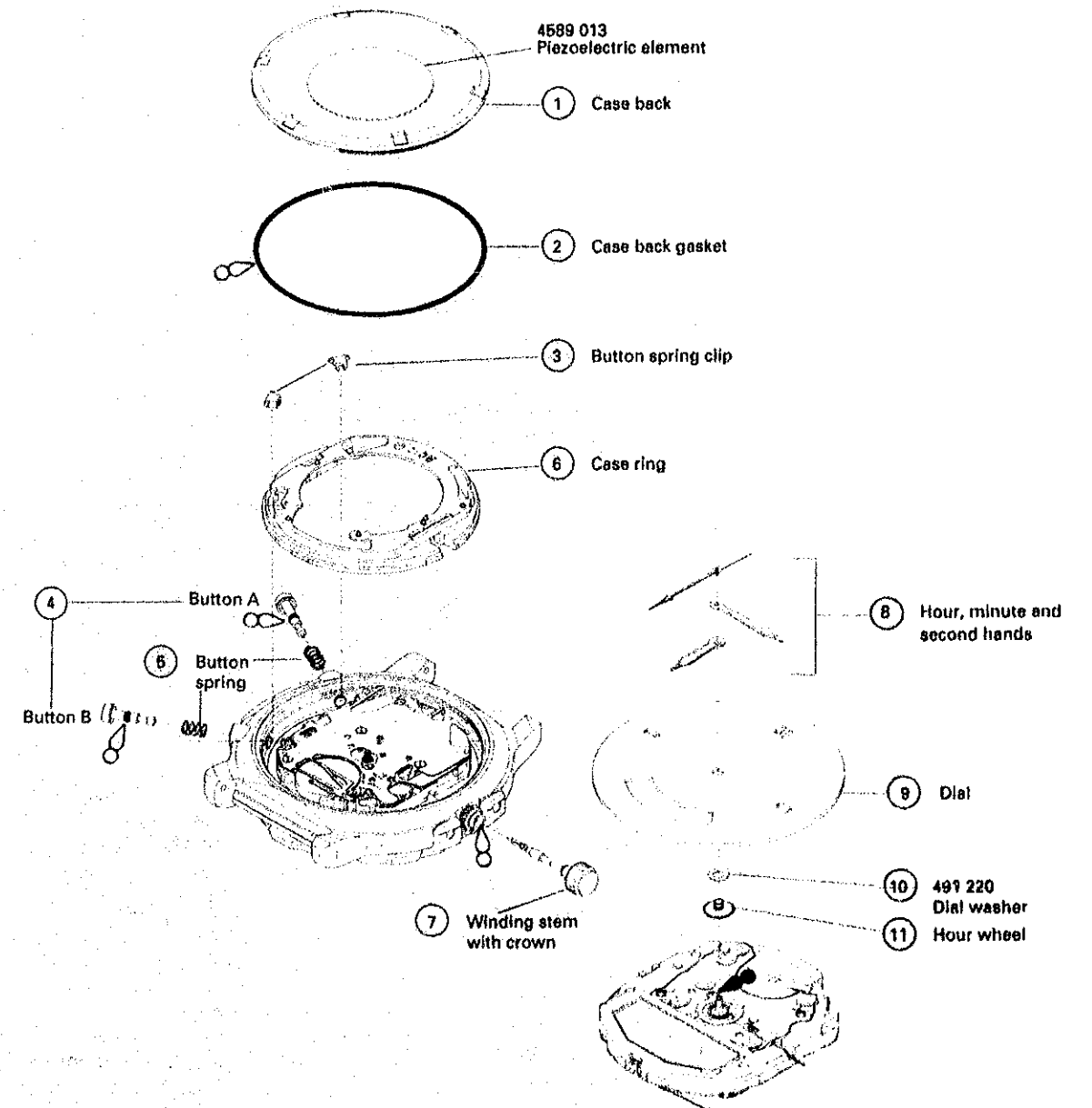

**Note:** If the button spring clips of the type shown in the illustration are used, it is necessary to disassemble both the button spring clips and the buttons when removing the movement from the case. Otherwise the movement can be removed as is.

○ → Please see the remarks on the following pages.

# PARTS CATALOGUE

Cal. V051A

# PARTS CATALOGUE

Cal. V051A

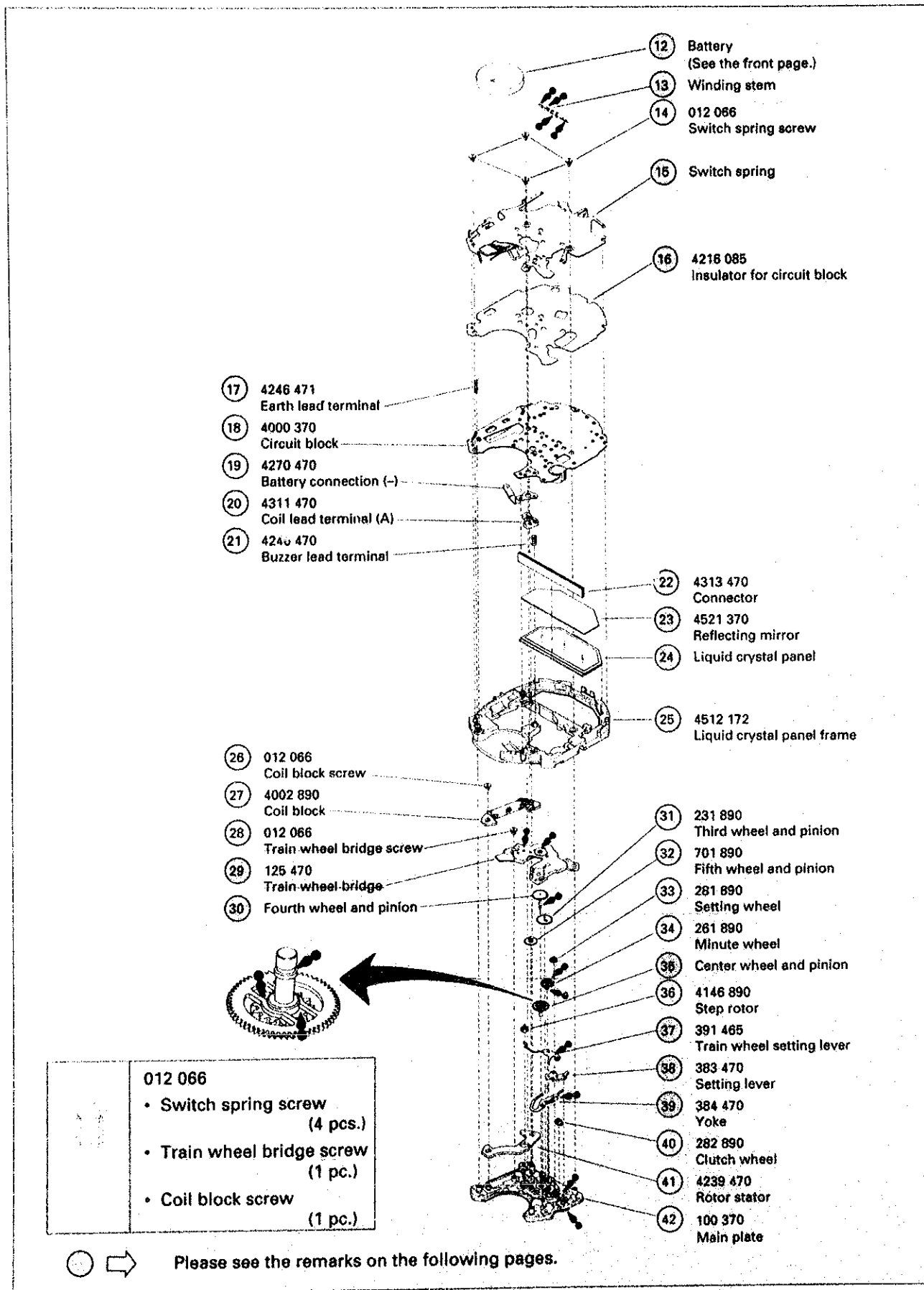





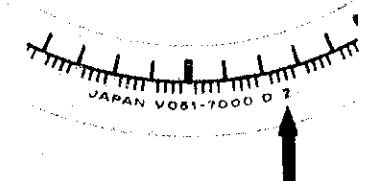
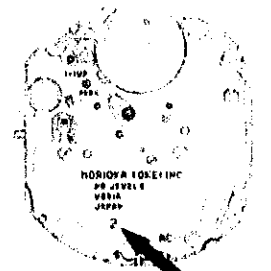

## Remarks

- ① Hour wheel
- ⑮ Switch spring
- ③④ Fourth wheel and pinion
- ③⑤ Center wheel and pinion

### • Discrimination of the installing height of the hands

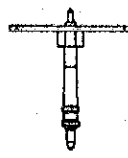
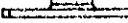
Cal. V051A watches have numerals printed on the dial and the movement to indicate the installing heights of hands. When repairing, refer to the table below.

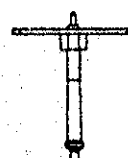
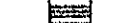
Discrimination	Height	Standard type	Standard type
	Numeral for discrimination	2	2
	Printed on	Dial	Movement
	Printed position		
		The numeral is printed at the right end.	The numeral is printed below the calibre number.

Numeral for discrimination	Center wheel and pinion	Fourth wheel and pinion	Hour wheel	Switch spring
1	 221 890	 241 466	 271 890	 4245 473
2	 221 892	 241 465	 271 892	 4245 471

③ Button spring clip

The type of button spring clip is determined based on the design of cases. Check the case number and refer to "CASING PARTS CATALOGUE" to choose a corresponding button spring clip.

⑤ Button spring

In some models, button spring is not used. Check the case number and refer to "CASING PARTS CATALOGUE" to choose a corresponding button spring.

⑬ Winding stem 351 890

The type of winding stem is determined based on the design of cases. Check the case number and refer to "CASING PARTS CATALOGUE" to choose a corresponding winding stem.

⑳ Liquid crystal panel

4510 370 (Silver)  
4510 372 (Gold)  
The type of liquid crystal panel is determined based on the design of cases. Check the case number and refer to "CASING PARTS CATALOGUE" to choose a corresponding liquid crystal panel.

• Other parts

• Bulb 4530 018

The bulb is available for supply separately from the circuit block, though they are soldered together.

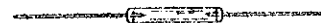

• Piezoelectric element 4589 013

Piezoelectric element, which is adhered to the inside of the case back, is available for supply separately from the case back.

- The explanation here is only for the particular points of Cal. V051A.
- For the repairing, checking and measuring procedures, refer to the "TECHNICAL GUIDE, GENERAL INSTRUCTIONS".

## I. STRUCTURE OF THE CIRCUIT BLOCK

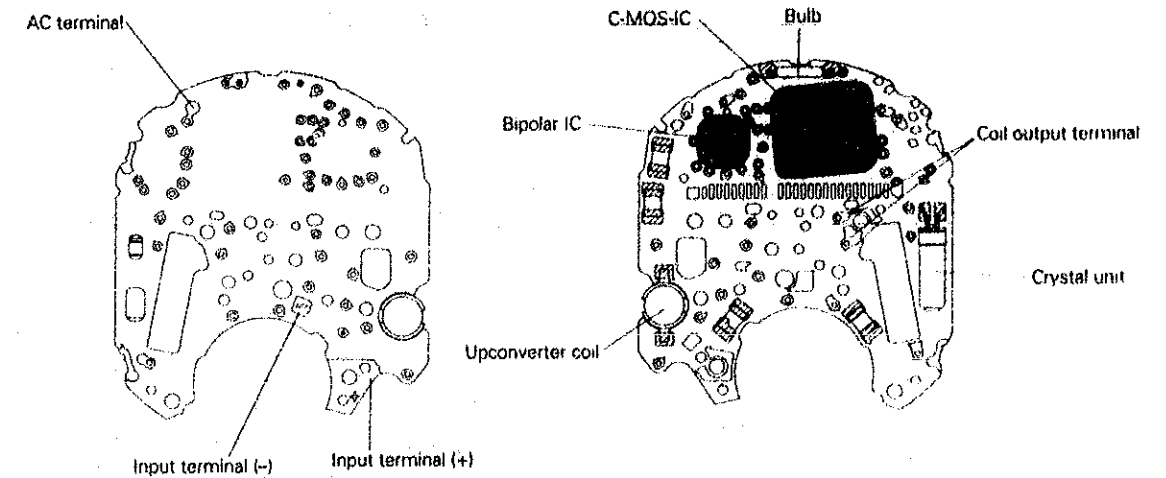

## II. REMARKS ON INSTALLING THE BATTERY

- After the battery is replaced with a new one, or after the battery is re-installed following the repairing procedures, be sure to short-circuit the AC terminal of the circuit block and the switch spring with conductive tweezers to reset the circuit as illustrated at right. (When checking the current consumption, short-circuit with the power supplied from external source.)
- To reset the circuit of the complete watch, pull out the crown to the first click and keep buttons "A" and "B" pressed at the same time for 1 to 2 seconds. "January 1st, Sunday" will be displayed.

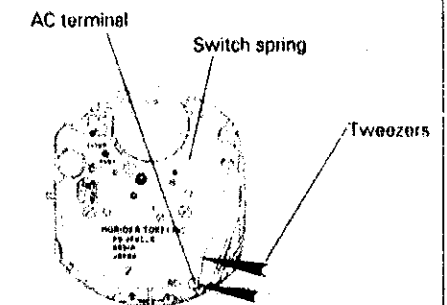

## III. REMARKS ON DISASSEMBLING AND REASSEMBLING

⑧ Hands

- Remarks on installing

When installing the hands, place the movement directly on a flat metal plate or the like.



# TECHNICAL GUIDE

Cal. V051A

## 13 Winding stem

### • How to remove

Insert the tip of a screwdriver into the hole marked with " ← PUSH", and while pushing the indented portion of the switch spring, pull out the winding stem.

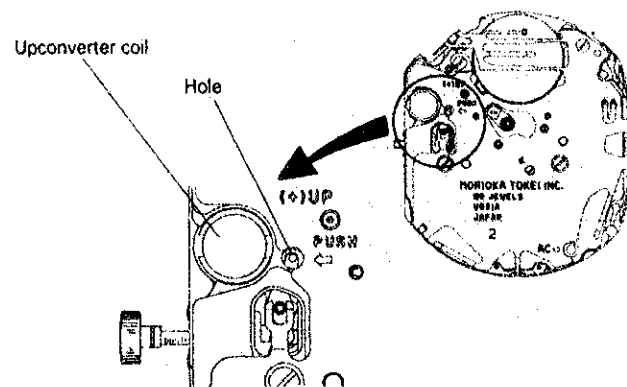

## 12 Battery

## 15 Switch spring

## 16 Insulator for circuit block

### • How to install

(1) Set the switch spring and insulator for circuit block in position, taking care not to damage the two guide pins for the liquid crystal panel, as they are very small. Then, tighten the four switch spring screws.

(2) Have the hook of the switch spring catch the liquid crystal panel frame.

(3) Insert the battery sideways, and have the hook of the switch spring's battery clamp portion catch the liquid crystal panel frame.

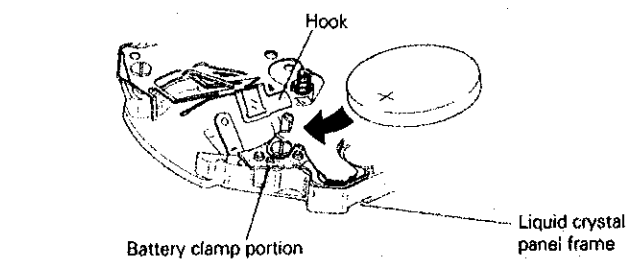
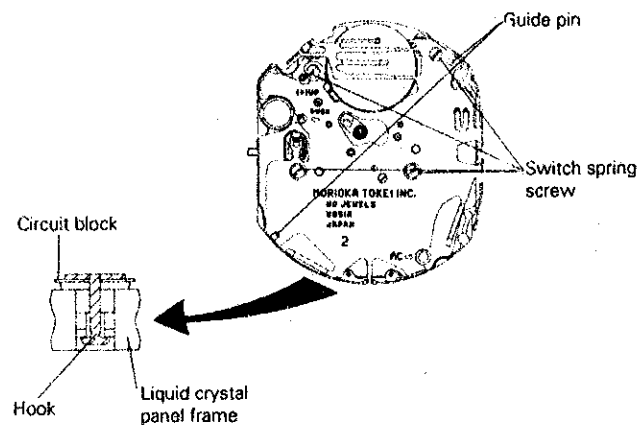

## 17 Earth lead terminal

## 21 Buzzer lead terminal

### • Setting position

Set the earth lead terminal and buzzer lead terminal in the direction as shown in the illustration at right.

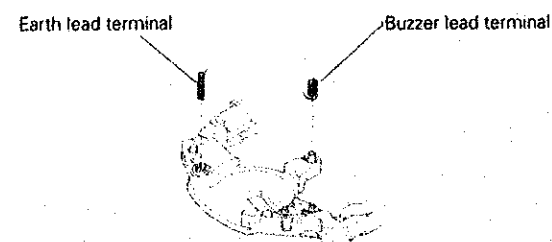

# TECHNICAL GUIDE

Cal. V051A

## 22 Connector

## 23 Reflecting mirror

## 24 Liquid crystal panel

### • How to install

(1) Slide the liquid crystal panel in the direction indicated by the arrow in the illustration to set it in position.

(2) Slide the reflecting mirror in the direction indicated by the arrow in the illustration until the other end of the reflecting mirror is set inside of the location guide pin.

(3) When setting the connector, check that it is not contaminated.

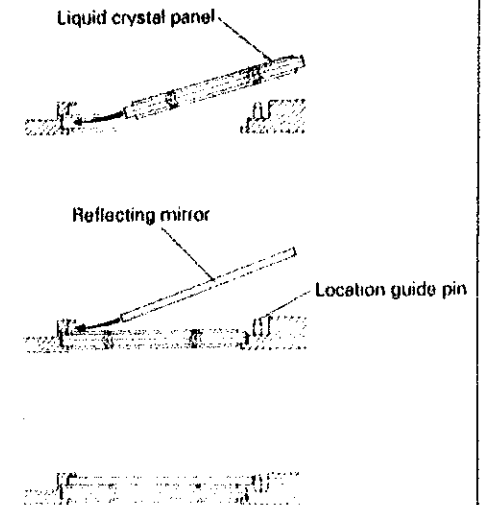

## 29 Train wheel bridge

### • Setting position

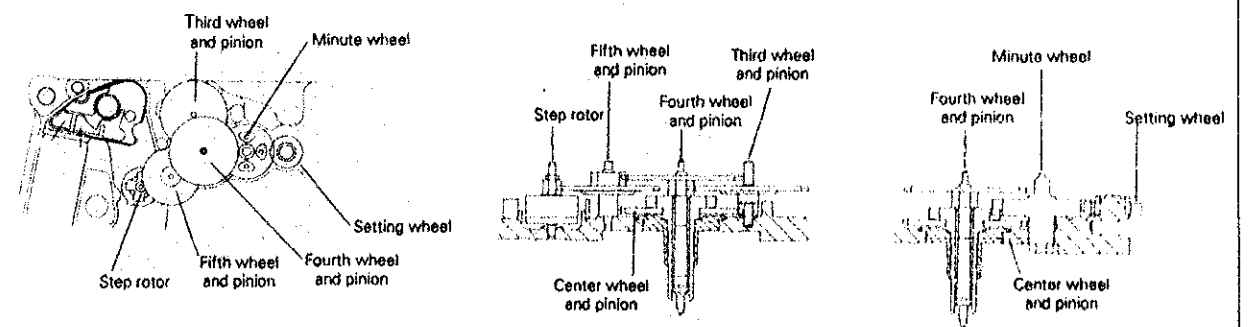

### Note:

Since the third wheel and pinion, fifth wheel and pinion, step rotor, and minute wheel are made of plastics, take care not to damage them in disassembling and reassembling.

# TECHNICAL GUIDE

Cal. V051A

MEMO

- ③⑦ Train wheel setting lever
- ③⑧ Setting lever
- ③⑨ Yoke

## • Setting position

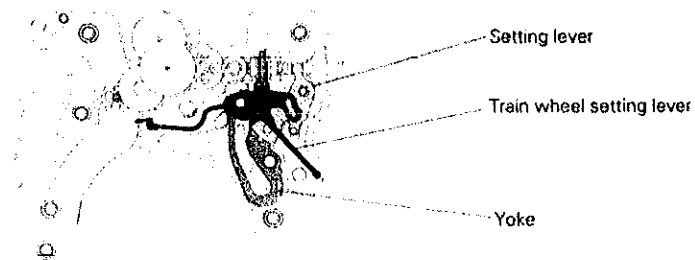

Take care not to deform the spring portion of the yoke.

## IV. VALUE CHECKING

### • Coil block resistance

2.4K $\Omega$  ~ 2.8K $\Omega$

### • Upconverter coil resistance

120 $\Omega$  ~ 180 $\Omega$

### • Current consumption

For the whole of the movement:	less than 2.1 $\mu$ A
For the circuit block alone :	less than 1.2 $\mu$ A

### Remarks:

Before measuring current consumption, it is necessary to reset the circuit with the power supplied from an external source. (Refer to "REMARKS ON INSTALLING THE BATTERY" on page 6.) Otherwise, the display will become disordered, and as a result, current consumption can not be measured properly. When the current consumption exceeds the standard value for the whole of the movement but is within the standard value range for the circuit block alone, overhaul and clean the movement parts and then measure current consumption for the whole of the movement again. The reason for this is that the driving puls generated to compensate for a heavy load that may be applied to the gear train, etc., is one possible cause of excessive current consumption by the whole of the movement.