



Cal. 7733

Mouvement ancre, chrono-
graphe-compteur 30 ou 45
minutes, 2 poussoirs,
mécanisme à came

Lever movement, recording
chronograph 30 or 45 minutes,
2 pushers, mechanism with
cam

Ankerwerk, Zähler-Chrono-
graph 30 oder 45 Minuten,
2 Drücker, Mechanismus mit
Nocken

Cal. 7734

avec quantième à guichet,
remise en date rapide

with date showing through
aperture in dial,
quick date-setting

mit Datum sichtbar durch
Fenster im Zifferblatt,
Schnell-Datumeinstellung

Cal. 7736

avec compteur 30 minutes,
compteur 12 heures

with 30 minutes recorder,
12 hours recorder

mit Zähler 30 Minuten,
Zähler 12 Stunden

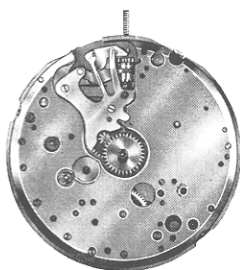

Cal. 7733



Cal. 7734



Cal. 7736

Caractéristiques techniques

Dimensions en mm

Cage	Calibre		
	7733	7734	7736
Diamètre d'encadrement	31,00	31,00	31,00
Diamètre total	31,30	31,30	31,30
Hauteur totale	6,00	6,65	7,40
Hauteur du filet	0,60	1,25	2,00
Hauteur axe de tige	1,85	2,50	3,25
Hauteur mécanisme quantième	—	0,65	—
Haut. méc. compteur d'heures	—	—	1,40

Echappement

Distance roue – ancre	3,15
Distance ancre – balancier	3,85
Diamètre de la roue	5,45
Diamètre du trou de la roue	0,50
Hauteur du plateau	0,90
Diamètre du trou du plateau	0,42
Distance de cheville	0,90
Angle de levée du balancier	48°

Balancier annulaire

Diamètre total	12,80
Diamètre du trou	1,00
Hauteur de la serge	0,60
Epaisseur du bras	0,25
Moment d'inertie en mgcm ²	40

Virole

Diamètre total	1,00
Diamètre du trou	0,48
Hauteur	0,53

Piton

Diamètre	0,70
Longueur pour spiral plat	1,80

Spiral (à titre d'information)

N° CGS	2,80
------------------	------

Barillet et bonde

Diamètre intérieur du tambour	12,40
Hauteur disponible pour ressort	1,70
Diamètre de la bonde	4,00

Ressort de barillet (à titre d'information)

Hauteur	1,60
Epaisseur	0,137
Longueur	400
Moment de force Mo en g·mm	1400

Aiguillage

Diamètre ajustement d'aiguille de minute	0,95
Diamètre ajustement d'aiguille d'heure	1,40/1,45
Diamètre ajustement d'aig. de petite seconde	0,18/0,20
Diamètre ajustement d'aig. de sec. au centre	0,27/0,30
Diamètre ajustement d'aig. de compt. minutes	0,27/0,30
Diamètre ajustement d'aig. de compt. d'heures	0,27/0,30

Tige de remontoir

Diamètre du filetage	1,20
--------------------------------	------

Cadran

Diamètre trous de pieds dans la platine	1,00
---	------

Fournitures du calibre de base 7733

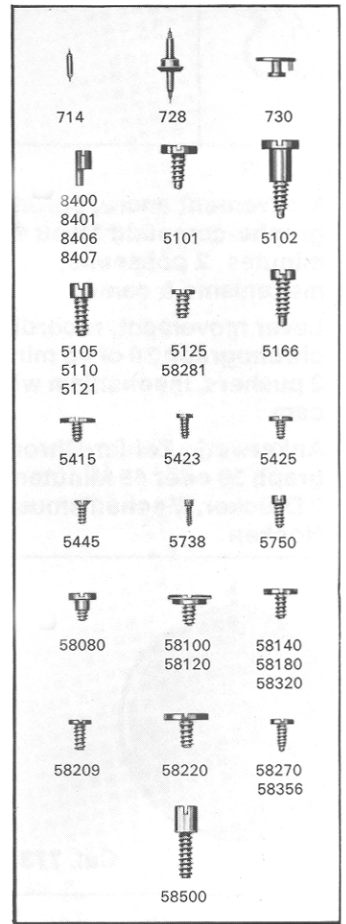
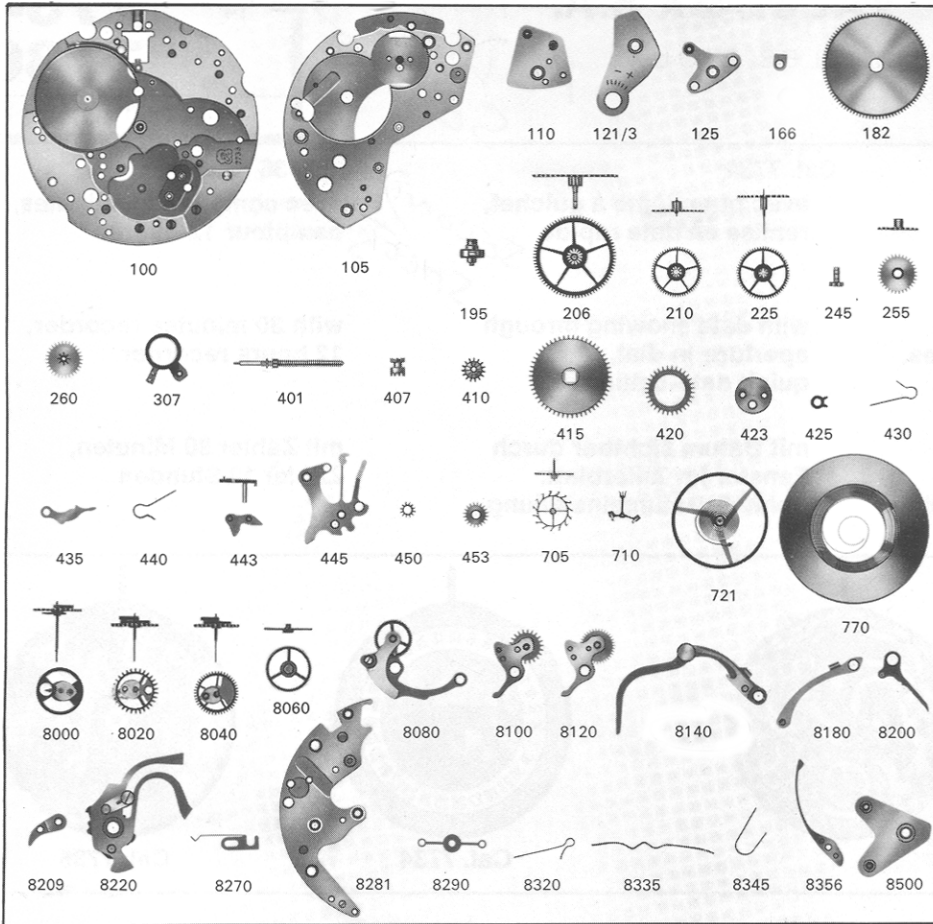

No	LISTE DES FOURNITURES	No.	LIST OF MATERIALS	Nr.	BESTANDTEILE
100	Platine	100	Plate	100	Werkplatte
105	Pont de barillet	105	Barrel bridge	105	Federhausbrücke
110	Pont de rouage	110	Train wheel bridge	110	Räderwerkbrücke
121/3	Coq pour porte-piton et pour dispositif amortisseur, spiral plat	121/3	Balance cock for stud holder and for shock-protecting device, flat hairspr.	121/3	Unruhklöben für Spiralklötzchen-Träger und Stoss-Sicherung, Flachspirale
125	Pont d'ancre	125	Pallet cock	125	Ankerklöben
166	Bride de fixation	166	Casing clamp	166	Werkbefestigungsbügel
182	Barillet avec couvercle	182	Barrel and cover	182	Federhaus mit Deckel
195	Arbre de barillet	195	Barrel arbor	195	Federwelle
206	Roue de centre	206	Center wheel	206	Minutenrad
210	Roue moyenne	210	Third wheel	210	Kleinbodenrad
225	Roue de seconde	225	Fourth wheel	225	Sekundenrad
245	Chaussée	245	Cannon pinion	245	Minutenrohr
255	Roue des heures	255	Hour wheel	255	Stundenrad
260	Roue de minuterie	260	Minute wheel	260	Wechselrad
307	Raquette avec porte-piton mobile, pour spiral plat	307	Regulator with adjustable stud holder, for flat hairspring	307	Rücker mit beweglichem Spiralklötzchen-Träger, für Flachspirale
401	Tige de remontoir	401	Winding stem	401	Aufzugwelle
407	Pignon coulant	407	Clutch wheel	407	Schiebtrieb
410	Pignon de remontoir	410	Winding pinion	410	Aufzugtrieb
415	Rochet	415	Ratchet wheel	415	Sperrad
420	Roue de couronne	420	Crown wheel	420	Kronrad
423	Noyau de roue de couronne	423	Crown wheel core	423	Kronradkern
425	Cliquet	425	Click	425	Sperrkegel
430	Ressort de cliquet	430	Click spring	430	Sperrkegelfeder
435	Bascule	435	Yoke	435	Wippe
440	Ressort de bascule	440	Yoke spring	440	Wippenfeder
443	Tirette	443	Setting lever	443	Stellhebel
445	Ressort de tirette	445	Setting lever spring	445	Stellhebelfeder
450	Renvoi	450	Setting wheel	450	Zeigerstellrad
453	Renvoi intermédiaire	453	Additional setting wheel	453	Zusatz-Zeigerstellrad
705	Roue d'ancre pivotée	705	Escape wheel and pinion with straight pivots	705	Ankerad mit Trieb
710	Ancre montée	710	Jewelled pallet fork and staff	710	Anker mit Welle
714	Tige d'ancre	714	Pallet staff	714	Ankerwelle
721	Balancier avec spiral plat	721	Balance with flat hairspring, regulated	721	Unruh mit Flachspirale
728	Axe de balancier pour dispositif amortisseur	728	Balance staff for shock-protecting device	728	Unruhwelle für Stoss-Sicherung
730	Plateau	730	Roller	730	Hebelscheibe
770	Ressort de barillet	770	Mainspring	770	Zugfeder
8000	Mobile de chronographe monté, 30 m	8000	Chronograph runner, mounted, 30 m	8000	Chrono-Zentrumrad, montiert, 30 m
8000/3	Mobile de chronographe monté, 45 m	8000/3	Chronograph runner, mounted, 45 m	8000/3	Chrono-Zentrumrad, montiert, 45 m
8020	Mobile monté du compteur de minutes, 30 m	8020	Minute-recording runner, mounted, 30 m	8020	Minutenzählrad, montiert, 30 m
8040	Mobile monté du compteur de minutes, 45 m	8040	Minute-recording runner, mounted, 45 m	8040	Minutenzählrad, montiert, 45 m
8060	Roue entraîneuse	8060	Driving wheel	8060	Mitnehmerrad
8080	Embrayage monté	8080	Coupling clutch, mounted	8080	Kupplung montiert
8100	Baladeur monté, 30 m	8100	Sliding gear, mounted, 30 m	8100	Sternradwippe, montiert, 30 m
8120	Baladeur monté, 45 m	8120	Sliding gear, mounted, 45 m	8120	Sternradwippe, montiert, 45 m
8140	Commande montée	8140	Operating lever, mounted	8140	Schalthebel, montiert
8180	Bascule de remise à zéro	8180	Fly-back lever	8180	Nullsteller
8200	Bloqueur	8200	Blocking lever	8200	Blockierhebel
8209	Couvre-bloqueur	8209	Blocking lever lid	8209	Blockierhebel-Deckplatte
8220	Marteau monté	8220	Hammer mounted	8220	Herzhebel, montiert



FABRIQUE D'ÉBAUCHES, CHRONOGRAPHES ET RATTRAPANTES

VALJOUX S.A., LES BIOUX

(SUISSE)

14'''

7733
7734
7736

31,00 mm

Complément aux caractéristiques techniques
Complement to the technical features
Ergänzung zu den Technischen Daten

Fournitures nouvelles ou d'exécution différente
New parts or parts of a different execution
Neue Bestandteile oder Bestandteile verschiedener Ausführung

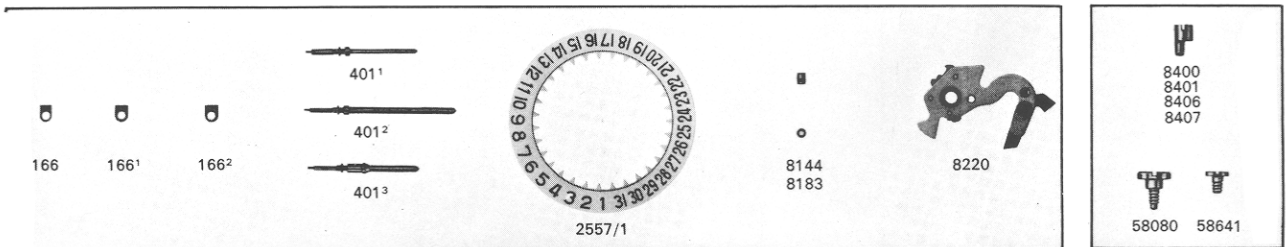

No	LISTE DES FOURNITURES	No	LIST OF MATERIALS	Nr.	BESTANDTEILE
166	Bride de fixation, épaisseur 0,30 mm	166	Casing clamp, thickness 0,30 mm	166	Werkbefestigungsbügel, Dicke 0,30 mm
166 ¹	Bride de fixation, épaisseur 0,40 mm	166 ¹	Casing clamp, thickness 0,40 mm	166 ¹	Werkbefestigungsbügel, Dicke 0,40 mm
166 ²	Bride de fixation, épaisseur 0,50 mm	166 ²	Casing clamp, thickness 0,50 mm	166 ²	Werkbefestigungsbügel, Dicke 0,50 mm
401 ¹	Tige de remontoir, filetage 0,90 mm longueur 15 mm	401 ¹	Winding stem, thread 0,90 mm, length 15 mm	401 ¹	Aufzugwelle, Gewinde 0,90 mm, Länge 15 mm
401 ²	Tige de remontoir, filetage 1,20 mm, longueur 20 mm	401 ²	Winding stem, thread 1,20 mm, length 20 mm	401 ²	Aufzugwelle, Gewinde 1,20 mm, Länge 20 mm
401 ³	Tige de remontoir, filetage 1,20 mm, longueur 16,80 mm, antichoc	401 ³	Winding stem, thread 1,20 mm, length 16,80 mm, shockproof	401 ³	Aufzugwelle, Gewinde 1,20 mm, Länge 16,80 mm, Stossicher
2557/1	Indicateur de quantième, décalqué	2557/1	Date indicator, transferred	2557/1	Datumanzeiger, mit Druckbild
8144	Tube de commande, diamètre fort	8144	Operating lever tube, large diameter	8144	Schalthebel-Lagerrohr, grosser Durchmesser
8183	Tube de bascule de remise à zéro, diamètre fort	8183	Fly-back lever tube, large diameter	8183	Nullsteller-Lagerrohr, grosser Durchmesser
8220	Marteau monté, auto-réglant	8220	Hammer mounted, self-regulating	8220	Herzhebel montiert, selbst-regulierend
8400	Excentrique de pivotement d'em- brayage, diamètre fort	8400	Eccentric for pivoting of coupling clutch, large diameter	8400	Exzenter für Kupplungs-Schwenkung, grosser Durchmesser
8401	Excentrique-appui d'embrayage, diamètre fort	8401	Banking eccentric for coupling clutch, large diameter	8401	Exzenter für Kupplungs-Anschlag, grosser Durchmesser
8406	Excentrique de pénétration du doigt, diamètre fort	8406	Finger-depth eccentric, large diameter	8406	Exzenter für Fingereingriff, grosser Durchmesser
8407	Excentrique de sautoir du compteur de minutes, diamètre fort	8407	Eccentric for minute-recording jumper, large diameter	8407	Exzenter für Minutenzählrad-Sperre, grosser Durchmesser
58080	Vis d'embrayage, filetage fort	58080	Coupling clutch screw, large thread	58080	Kupplungs-Schraube, grosses Gewinde
58641	Vis de couvre-interrupteur, filetage fort.	58641	Switch lid screw, large thread	58641	Unterbrecher-Halter-Schraube, grosses Gewinde

No	LISTE DES FOURNITURES	No.	LIST OF MATERIALS	Nr.	BESTANDTEILE
8270	Sautoir du compteur de minutes	8270	Minute-recording jumper	8270	Minutenzählrad-Sperre
8281	Planche du mécanisme de chronographe	8281	Plate for chronograph mechanism	8281	Platte für Chronomechanismus
8290	Ressort-friction du mobile de chronographe	8290	Friction spring for chronograph runner	8290	Friktionsfeder für Chrono-Zentrumrad
8320	Ressort d'embrayage	8320	Coupling clutch spring	8320	Kupplungsfeder
8335	Ressort de commande	8335	Operating lever spring	8335	Schalthebelfeder
8345	Ressort de bloqueur	8345	Blocking lever spring	8345	Blockierhebelfeder
8356	Sautoir de came de marteau	8356	Hammer cam jumper	8356	Sperre für Herzhebelbegrenzer
8400	Excentrique de pivotement d'embrayage	8400	Eccentric for pivoting of coupling clutch	8400	Exzenter für Kupplungs-Schwenkung
8401	Excentrique-appui d'embrayage	8401	Banking eccentric for coupling clutch	8401	Exzenter für Kupplungs-Anschlag
8406	Excentrique de pénétration du doigt	8406	Finger-depth eccentric	8406	Exzenter für Fingeringriff
8407	Excentrique de sautoir du compteur de minutes	8407	Eccentric for minute-recording jumper	8407	Exzenter für Minutenzählrad-Sperre
8500	Pont de chronographe	8500	Chronograph bridge	8500	Chrono-Brücke
5101	Vis de fixation	5101	Case screw	5101	Werkbefestigungs-Schraube
5102	Vis de fixation, spéciale	5102	Case screw, special	5102	Werkbefestigungs-Schraube, Spez.-Ausfg.
5105	Vis de pont de barillet	5105	Barrel bridge screw	5105	Federhausbrücken-Schraube
5110	Vis de pont de rouage	5110	Train wheel bridge screw	5110	Räderwerkbrücken-Schraube
5121	Vis de coq	5121	Balance cock screw	5121	Unruhloben-Schraube
5125	Vis de pont d'ancre	5125	Pallet cock screw	5125	Ankerloben-Schraube
5166	Vis de bride de fixation	5166	Casing clamp screw	5166	Werkbefestigungsbügel-Schraube
5415	Vis de rochet	5415	Ratchet wheel screw	5415	Sperrad-Schraube
5423	Vis de noyau de roue de couronne	5423	Screw for crown wheel core	5423	Kronradkern-Schraube
5425	Vis de cliquet	5425	Click screw	5425	Sperrkegel-Schraube
5445	Vis de ressort de tirette	5445	Screw for setting lever spring	5445	Stellhebelfeder-Schraube
5738	Vis de piton	5738	Hairspring stud screw	5738	Spiralklötzchen-Schraube
5750	Vis de cadran	5750	Dial screw	5750	Zifferblatt-Schraube
58080	Vis d'embrayage	58080	Coupling clutch screw	58080	Kupplungs-Schraube
58100	Vis de baladeur	58100	Sliding gear screw	58100	Sternradwippen-Schraube
58120	Vis de baladeur	58120	Sliding gear screw	58120	Sternradwippen-Schraube
58140	Vis de commande	58140	Operating lever screw	58140	Schalthebel-Schraube
58180	Vis de bascule de remise à zéro	58180	Fly-back lever screw	58180	Nullsteller-Schraube
58209	Vis de couvre-bloqueur	58209	Screw for blocking lever lid	58209	Schraube für Blockierhebel-Deckplatte
58220	Vis de marteau	58220	Hammer screw	58220	Herzhebel-Schraube
58270	Vis de sautoir du compteur de minutes	58270	Minute-recording jumper screw	58270	Schraube für Minutenzählrad-Sperre
58281	Vis de planche du mécanisme chronographe	58281	Screw for plate of chronograph mechanism	58281	Schraube für Chronomechanismus-Platte
58320	Vis de ressort d'embrayage	58320	Scw for coupling clutch spring	58320	Kupplungsfeder-Schraube
58356	Vis de sautoir de came de marteau	58356	Screw for hammer cam jumper	58356	Schraube für Herzhebelbegrenzer-Sperre
58500	Vis de pont de chronographe	58500	Chronograph bridge screw	58500	Chrono-Brücken-Schraube

Fournitures particulières au mécanisme quantième cal. 7734

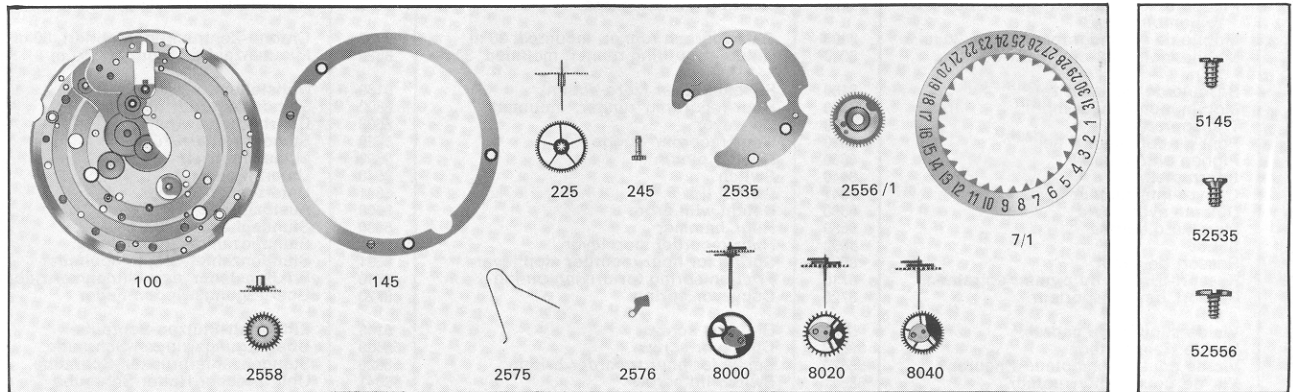

No	LISTE DES FOURNITURES	No.	LIST OF MATERIALS	Nr.	BESTANDTEILE
100	Platine	100	Plate	100	Werkplatte
145	Support de cadran	145	Dial rest	145	Zifferblatt-Stütze
225	Roue de seconde, deux longs pivots	225	Fourth wheel, two long pivots	225	Sekundenrad mit zwei langen Zapfen
245	Chaussée	245	Cannon pinion	245	Minutenrohr
2535	Plaque de maintien de l'indicateur de quantième	2535	Date indicator guard	2535	Halteplatte für Datumanzeiger
2556/1	Roue entraîneuse de l'indicateur de quantième, monté	2556/1	Date indicator driving wheel, mounted	2556/1	Datumanzeiger-Mitnehmerrad, montiert
2557/1	Indicateur de quantième pour cadran plat, décalqué	2557/1	Date indicator for flat dial, transferred	2557/1	Datumanzeiger für flaches Zifferblatt, mit Druckbild
2558	Roue des heures double denture	2558	Double-toothing hour wheel	2558	Stundenrad mit Doppelzahnung
2575	Ressort du sautoir de quantième	2575	Date jumper spring	2575	Feder für Datumsperre
2576	Sautoir de quantième	2576	Date jumper	2576	Datumsperre
8000	Mobile de chronographe monté, 30 m	8000	Chronograph runner, mounted, 30 m	8000	Chrono-Zentrumrad, montiert, 30 m
8000/3	Mobile de chronographe monté, 45 m	8000/3	Chronograph runner, mounted, 45 m	8000/3	Chrono-Zentrumrad, montiert, 45 m
8020	Mobile monté du compteur de minutes, 30 m	8020	Minute-recording runner, mounted, 30 m	8020	Minutenzählrad montiert, 30 m
8040	Mobile monté du compteur de minutes, 45 m	8040	Minute-recording runner, mounted, 45 m	8040	Minutenzählrad, montiert, 45 m
5145	Vis du support de cadran	5145	Dial rest screw	5145	Zifferblatt-Stütze-Schraube
52535	Vis de plaque de maintien de l'indicateur de quantième	52535	Screw for date indicator guard	52535	Halteplatte-Schraube für Datumanzeiger
52556	Vis de roue entraîneuse de l'indicateur de quantième	52556	Screw for date indicator driving wheel	52556	Schraube für Datumanzeiger-Mitnehmerrad

Fournitures particulières au compteur 12 heures cal. 7736

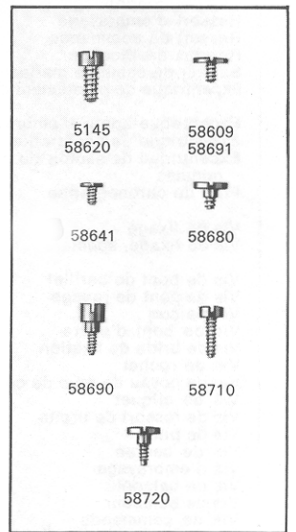
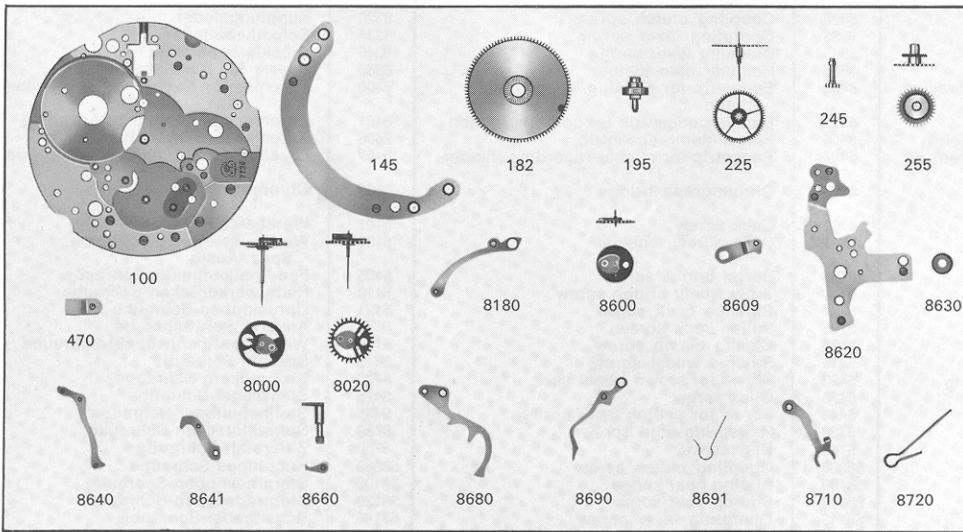

No	LISTE DES FOURNITURES	No.	LIST OF MATERIALS	Nr.	BESTANDTEILE
100	Platine	100	Plate	100	Werkplatte
145	Support de cadran	145	Dial rest	145	Zifferblatt-Stütze
182	Barillet avec couvercle	182	Barrel and cover	182	Federhaus mit Deckel
195	Arbre de barillet	195	Barrel arbor	195	Federwelle
225	Roue de seconde, deux longs pivots	225	Fourth wheel, two long pivots	225	Sekundenrad mit zwei langen Zapfen
245	Chaussée	245	Cannon pinion	245	Minutenrohr
255	Roue des heures	255	Hour wheel	255	Stundenrad
470	Plaquette-maintien du pignon de remontoir	470	Winding pinion guard	470	Halteplatte für Aufzugtrieb
8000	Mobile de chronographe monté, 30 m	8000	Chronograph runner, mounted, 30 m	8000	Chrono-Zentrumrad, montiert, 30 m
8020	Mobile monté du compteur de min., 30 m	8020	Minute-recording runner, mounted, 30 m	8020	Minutenzählrad montiert, 30 m
8180	Bascule de remise à zéro	8180	Fly-back lever (zero action)	8180	Nullsteller
8600	Mobile monté du compteur d'heures	8600	Hour-recording runner, mounted	8600	Stundenzählrad, montiert
8609	Transporteur	8609	Conveyor	8609	Übertragungswippe
8620	Pont du compteur d'heures	8620	Hour recorder bridge	8620	Stundenzähler-Brücke
8630	Pignon entraîneur	8630	Driving pinion	8630	Mitnehmertrieb
8640	Interrupteur	8640	Switch	8640	Unterbrecher
8641	Couvre-interrupteur	8641	Switch lid	8641	Unterbrecher-Halter
8660	Détente avec arbre	8660	Detent with arbor	8660	Auslöser mit Welle
8680	Marteau d'heures	8680	Hour hammer	8680	Stundenherzhebel
8690	Sabot	8690	Hour recorder stop lever	8690	Stundenzähler-Stopphebel
8691	Ressort de sabot	8691	Spring for hour recorder stop lever	8691	Stundenzähler-Stopphebelfeder
8710	Ressort-friction du pignon entraîneur	8710	Friction spring for driving pinion	8710	Friktionsfeder des Mitnehmertriebes
8720	Ressort de transporteur	8720	Conveyor spring	8720	Übertragungswippen-Feder
5145	Vis de support de cadran	5145	Dial rest screw	5145	Zifferblatt-Stützen-Schraube
58609	Vis de transporteur	58609	Conveyor screw	58609	Übertragungswippen-Schraube
58620	Vis de pont du compteur d'heures	58620	Screw for hour recorder bridge	58620	Stundenzählerbrücken-Schraube
58641	Vis de couvre-interrupteur	58641	Switch lid screw	58641	Unterbrecher-Halter-Schraube
58680	Vis de marteau d'heures	58680	Hour hammer screw	58680	Stundenherzhebel-Schraube
58690	Vis de sabot	58690	Hour recorder stop lever scrow	58690	Stundenzähler-Stopphebel-Schraube
58691	Vis de ressort de sabot	58691	Screw for spring for hour recorder stop lever	58691	Stundenzähler-Stopphebelfeder-Schraube
58710	Vis de ressort-friction du pignon entraîneur	58710	Friction spring screw for driving pinion	58710	Friktionsfeder-Schraube des Mitnehmertriebes
58720	Vis de ressort du transporteur	58720	Conveyor spring screw	58720	Übertragungswippenfeder-Schraube



7733
14''' 7734
7736
31.00 mm

RF 7733

dia. 31.00 mm

Chronograph movement, minute-re-
corder (30 or 45 m), 2 pushers, cam
mechanism, 18,000 vibrations per hour,
height 6.00 mm.



Fig. 1



Fig. 2

Derived calibers

RF 7734

Chronograph movement, minute-re-
corder (30 or 45 m), 2 pushers, cam
mechanism, 18,000 vibrations per hour,
date shown through an aperture in the
dial, height 6.65 mm.



Fig. 3

RF 7736

Chronograph, recorders (30 m and
12 hours), 2 pushers, cam mechanism,
18,000 vibrations per hour, height
7.40 mm.

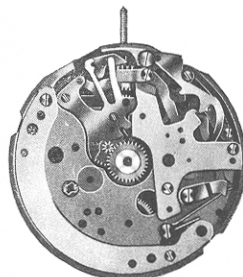

Fig. 4



1. Introduction

This technical communication is intended for watchmakers who wish to familiarize themselves with the method of repairing these chronograph calibers.

2. Dismantling the movement

- 2.1. Dismantling the hour-recorder mechanism of caliber 7736.
- 2.2. Dismantling the date-indicator mechanism of caliber 7734.
- 2.3. Dismantling the chronograph mechanism of calibers 7733, 7734 and 7736.

Important

Before starting the above operations, remove the hands and the dial. Let down the barrel; for this purpose, set the chronograph mechanism to the return-to-zero position and hold back the click with a small pointed tool or screw-driver (see fig. 5).

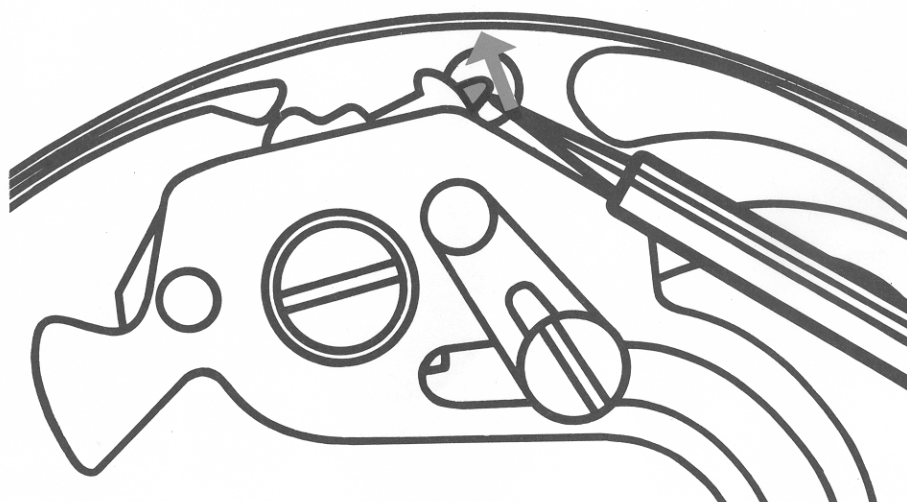

Fig. 5

2.1. Dismantling the hour-recorder mechanism of caliber 7736

- 2.1.1. Remove the hour wheel No. 255 and the cannon pinion No. 245.
- 2.1.2. Loosen and take out the screw No. 58710 of the driving-pinion friction spring; remove the driving-pinion friction spring No. 8710 and the winding-pinion guard No. 470.
- 2.1.3. Loosen and take out the hour-hammer screw No. 58680 and remove the hour hammer No. 8680.
- 2.1.4. Loosen and take out the screw No. 58690 of the hour-recorder stop lever and remove the hour-recorder stop lever No. 8690.
- 2.1.5. Loosen and take out the switch-lid screw No. 58641 and remove the switch lid No. 8641.
- 2.1.6. Loosen and take out the conveyor screw No. 58609 and remove the conveyor No. 8609.
- 2.1.7. Loosen the conveyor-spring screw No. 58720 and remove the conveyor spring No. 8720.
- 2.1.8. Remove the switch No. 8640.
- 2.1.9. Loosen and take out the 2 screws No. 58620 of the hour-recorder bridge and remove the hour-recorder bridge No. 8620, with the hour-recorder stop lever still in position.
- 2.1.10. Remove: the driving pinion No. 8630
the hour-recorder runner No. 8600.
For cleaning the movement, it is unnecessary to remove the dial rest No. 145.

- 2.2.2. Loosen and take out the screw No. 52556/1 of the date-indicator driving-wheel and remove the date-indicator driving-wheel No. 2556/1.
- 2.2.3. Loosen the two screws No. 52535 of the date-indicator guard.
Remove:
the date-indicator guard No. 2535,
the date jumper No. 2576,
the date-indicator No. 2557,
the double-toothing hour wheel No. 2558,
the cannon pinion No. 245.
- 2.2.4. Loosen the three dial-rest screws No. 5145 and remove the dial rest No. 145.

2.2. Dismantling the date-indicator mechanism of caliber 7734

- 2.2.1. Remove the date-jumper spring No. 2575 (fig. 6).

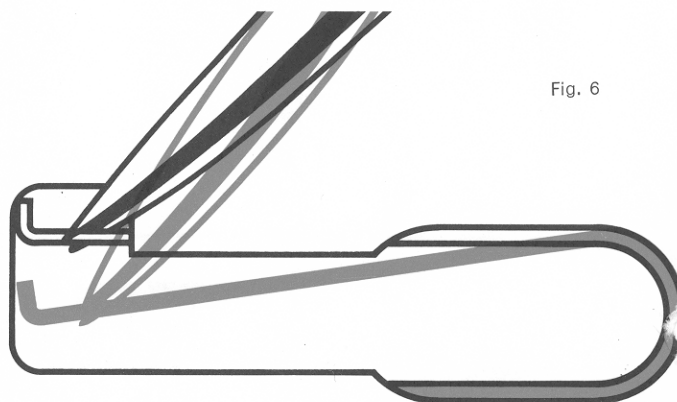

Fig. 6

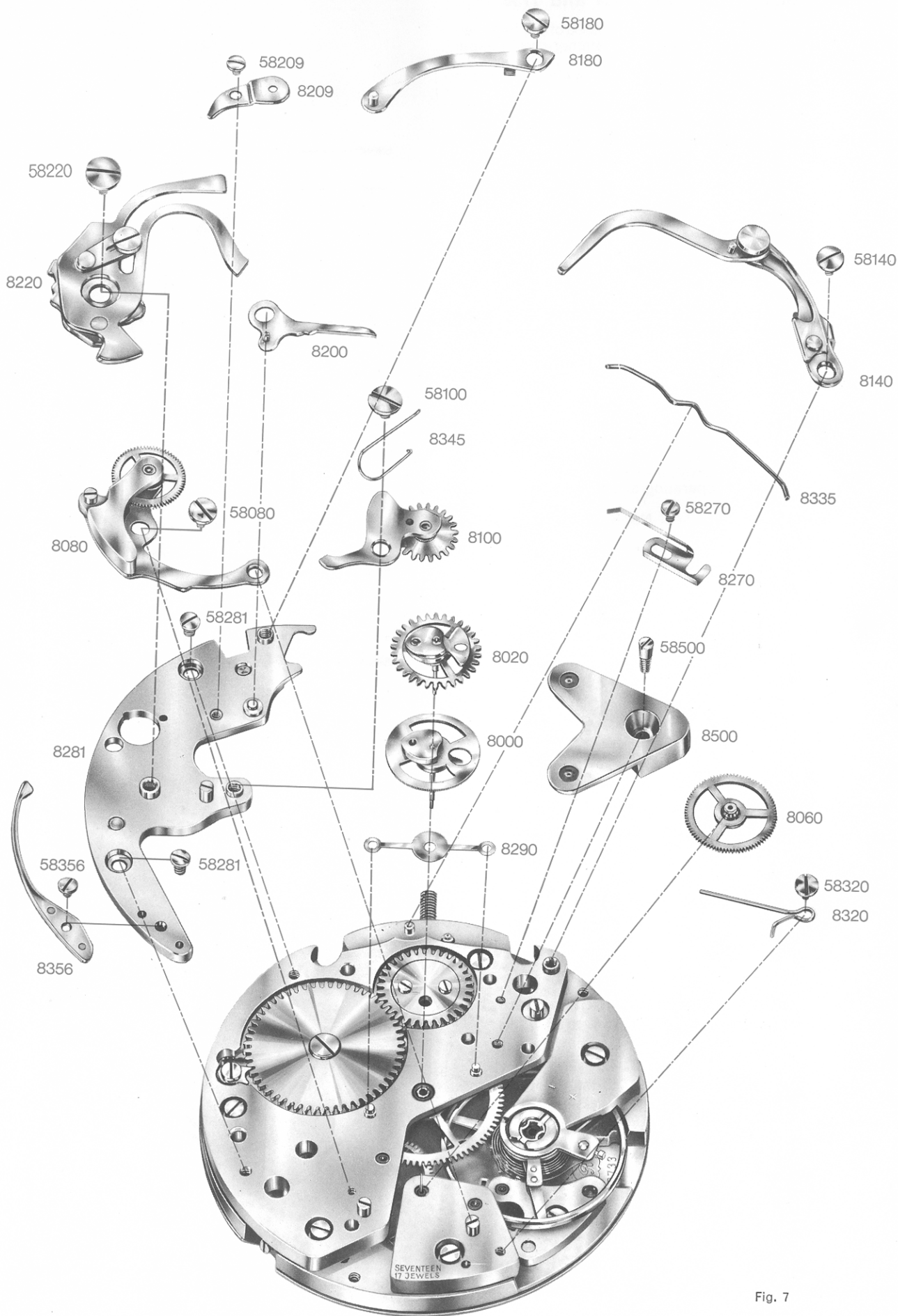

Fig. 7

2.3. Dismantling the chronograph mechanism of calibers 7733, 7734 and 7736

- 2.3.1. Loosen and take out the screw No. 58356 of the hammer-cam jumper and remove the hammer-cam jumper No. 8356.
- 2.3.2. Loosen and take out the hammer screw No. 58220 and remove the hammer No. 8220.
- 2.3.3. Loosen and take out the screw No. 58180 of the fly-back lever and remove the fly-back lever No. 8180.
- 2.3.4. Loosen and take out the operating-lever screw No. 58140 and remove:
 - the operating-lever No. 8140.
- 2.3.5. Loosen and take out the screw No. 58209 of the blocking-lever lid and remove the blocking-lever lid No. 8209, the blocking-lever No. 8200 and the blocking-lever spring No. 8345.
- 2.3.6. Loosen and take out the sliding-gear screw No. 58100 and remove the sliding-gear No. 8100.
- 2.3.7. Loosen and take out the coupling-clutch screw No. 58080 and remove the coupling-clutch No. 8080.
- 2.3.8. Loosen and take out the screw No. 58270 of the minute-recording jumper and remove the minute-recording jumper No. 8270.
- 2.3.9. Loosen and take out the chronograph-bridge screw No. 58500 and remove:
 - the chronograph bridge No. 8500,
 - the minute-recording runner No. 8020,
 - the chronograph-runner No. 8000,
 - the chronograph-runner friction spring No. 8290.
- 2.3.10. Loosen the two screws No. 58281 of the chronograph-mechanism plate; remove the chronograph-mechanism plate No. 8281, the operating and fly-back lever spring No. 8335.
- 2.3.11. Remove the driving-wheel No. 8060, using a suitable tool.
For cleaning the movement, it is unnecessary to remove the coupling-clutch spring No. 8320.

Cleaning

This movement can be cleaned in a suitable machine, with the usual solutions. During the cleaning process, it is however advisable to avoid damaging the teeth of the chronograph and coupling-clutch wheels.

3. Assembling

- 3.1. Assembling the chronograph-mechanism of calibers 7733, 7734 and 7736.
- 3.2. Assembling the hour-recorder mechanism of caliber 7736.
- 3.3. Assembling the date-indicator mechanism of caliber 7734.

3.1. Assembling the chronograph-mechanism of calibers 7733, 7734 and 7736

Important

When assembling the train of caliber 7736, the following parts must first be fitted on the dial side:

the driving-pinion, taking care first of all to lubricate the portion of the barrel arbor with which it works;
lubricate the pivot of the hour-recorder runner on the plate side and fit the runner in position;
fit the hour-recorder bridge and tighten its two screws.

- 3.1.1. Fit:
 - the chronograph-runner friction spring, taking care to lubricate the portion that rubs against the chronograph-runner finger;
 - the chronograph-runner;
 - the minute-recording runner;
 - the chronograph bridge and screw it tight.

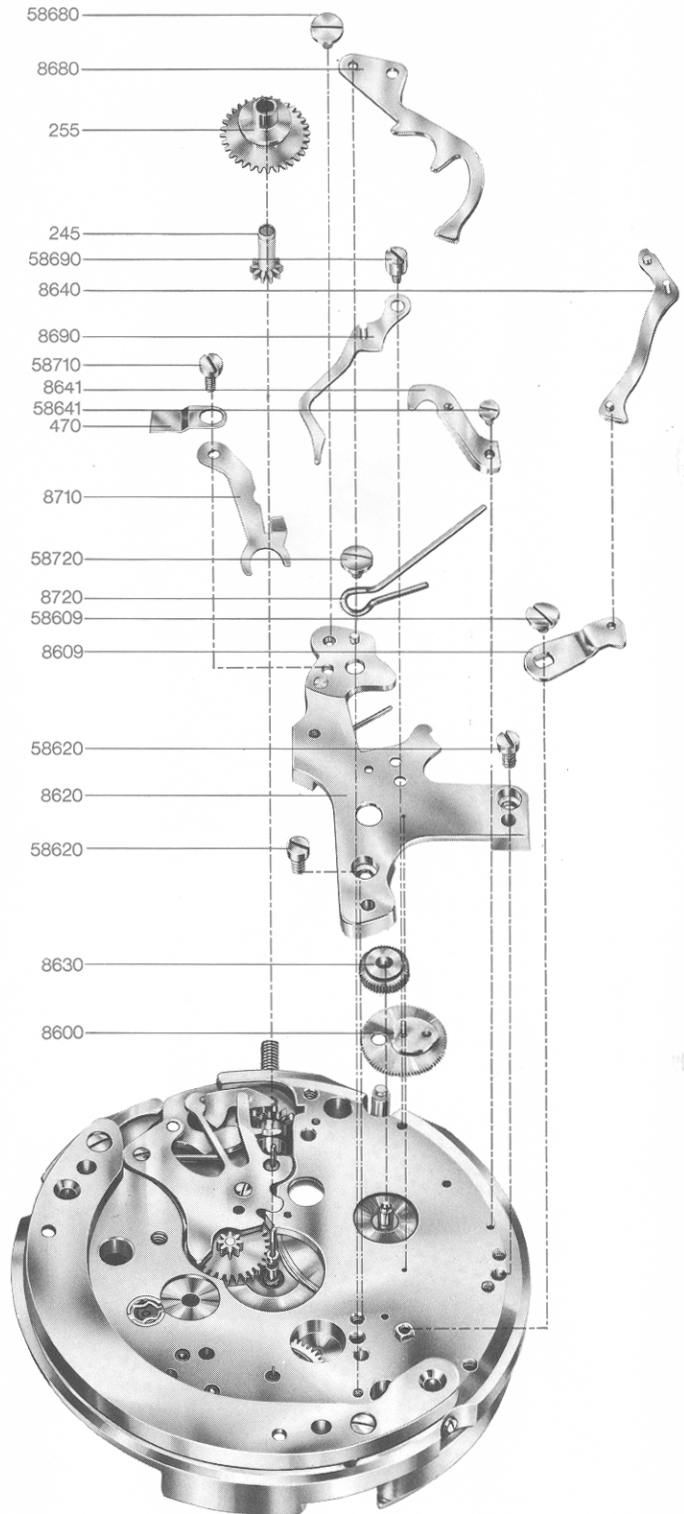

Fig. 8

- 3.1.2. Fit the chronograph-mechanism plate and screw it tight.
- 3.1.3. Fit the operating-lever spring (fig. 9).



Fig. 9

- 3.1.4. Fit the fly-back lever on to its stud and screw it tight.
- 3.1.5. With the reverser in the working position, fit the operating-lever (fig. 10) and screw it tight.

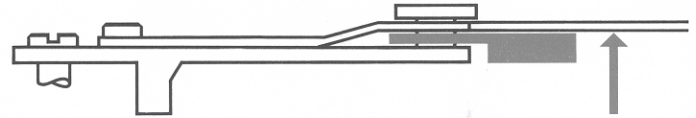

Fig. 10

- 3.1.6. Fit:
 - the sliding gear on to its stud and screw it tight;
 - the blocking-lever on to its stud;
 - the blocking-lever lid and screw it tight;
 - the blocking-lever spring (fig. 11).

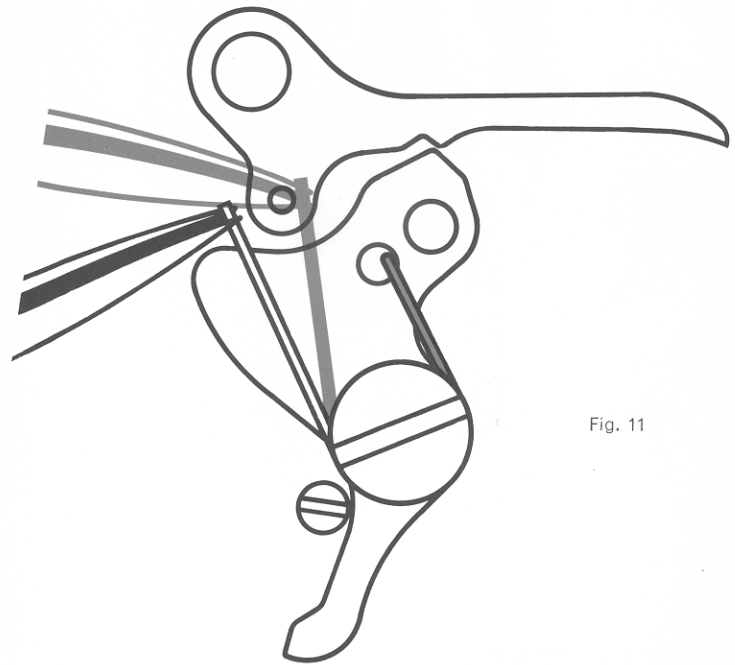

Fig. 11

- 3.1.7. Fit the minute-recording jumper and screw it tight.
- 3.1.8. Check:
 - Regulate the penetration of the finger by means of the eccentric No. 8406 and the position of the minute-recording jumper by means of the eccentric No. 8407 (fig. 12).
 - (In the case of caliber 7736, fit the detent No. 8660).

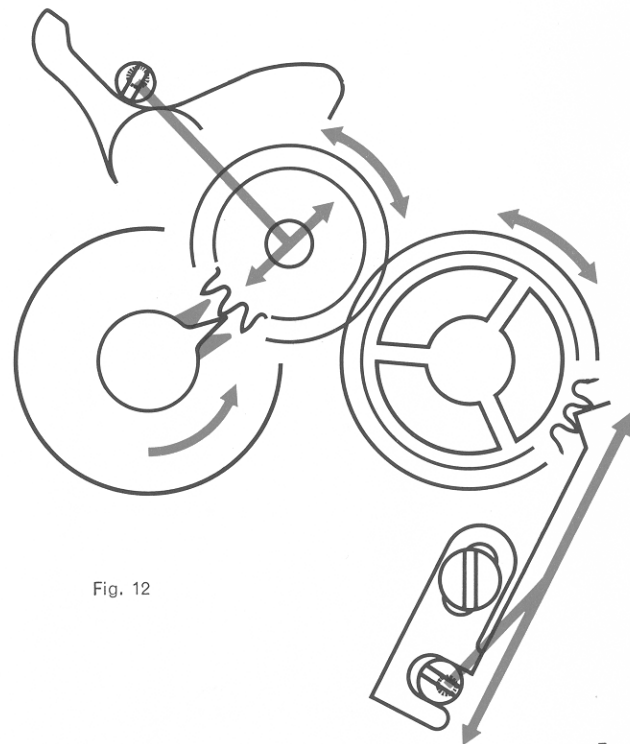

Fig. 12

- 3.1.9. Fit the hammer, lubricate its pivoting-point, screw it tight and check its shake, which should be slight.
- 3.1.10. Fit the hammer-cam jumper and screw it tight. Check: the working of the reverser (fig. 13) by moving the operating-lever;

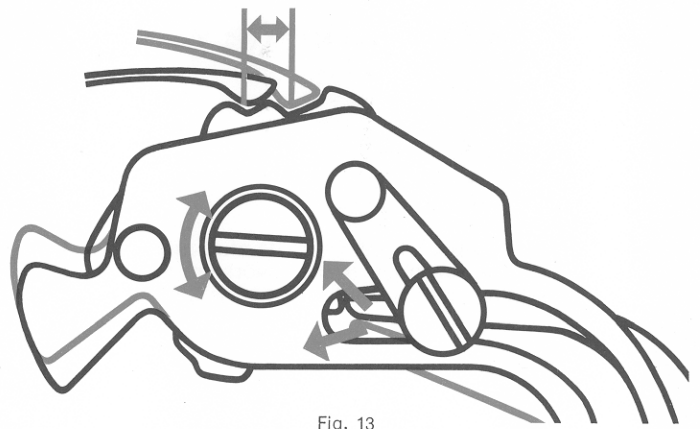

Fig. 13

the return-to-zero action of the hearts by moving the fly-back lever (fig. 14).

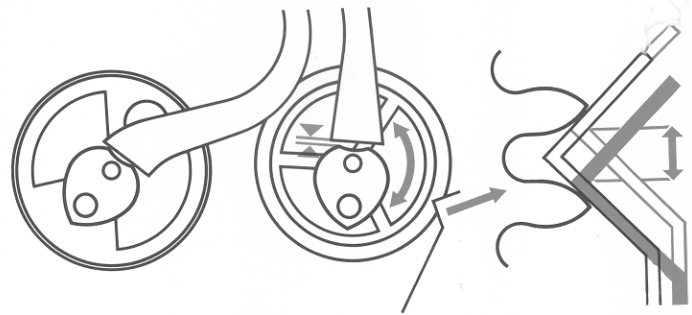

Fig. 14

- 3.1.11. Fit the coupling-clutch and screw it tight, taking care first of all to lubricate the lower coupling-wheel pivot. Check the action of the coupling-clutch, which should be perfectly free.
- 3.1.12. Fit the driving-wheel, which should be flush with the coupling-wheel.
- 3.1.13. Check the depth of the gearing (fig. 15).

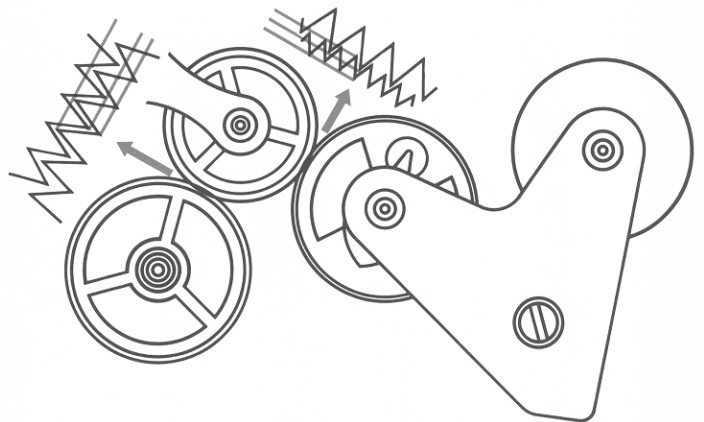
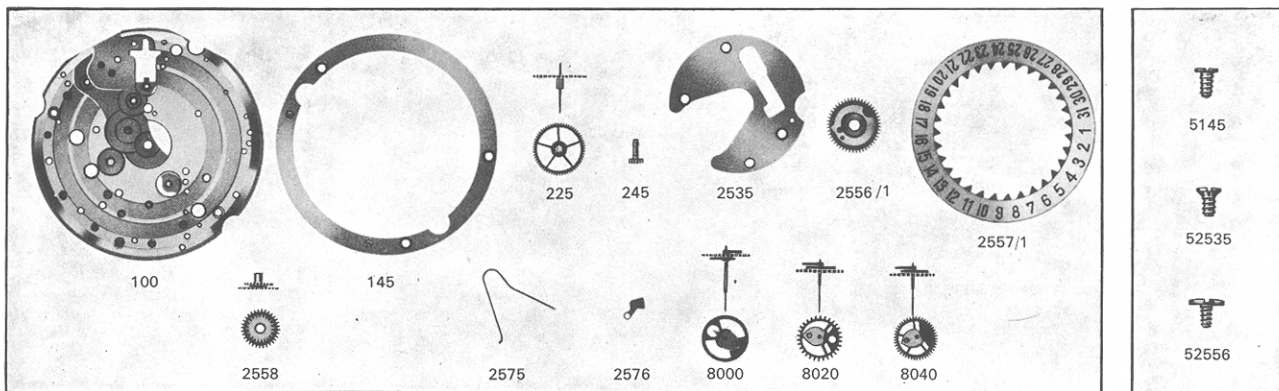

Fig. 15

Special components for the date-indicator mechanism of caliber 7734



No. LIST OF MATERIALS

100	Plate	2575	Date jumper spring
145	Dial rest	2576	Date jumper
225	Fourth wheel, two long pivots	8000	Chronograph runner, mounted, 30 m
245	Cannon pinion	8000/3	Chronograph runner, mounted, 45 m
2535	Date indicator guard	8020	Minute-recording runner, mounted, 30 m
2556/1	Date indicator driving wheel, mounted	8040	Minute-recording runner, mounted, 45 m
2557/1	Date indicator for flat dial, transferred	5145	Dial rest screw
2558	Double-toothing hour wheel	52535	Screw for date indicator guard
		52556	Screw for date indicator driving wheel

Special components for the hour-recorder (12 hours) of caliber 7736

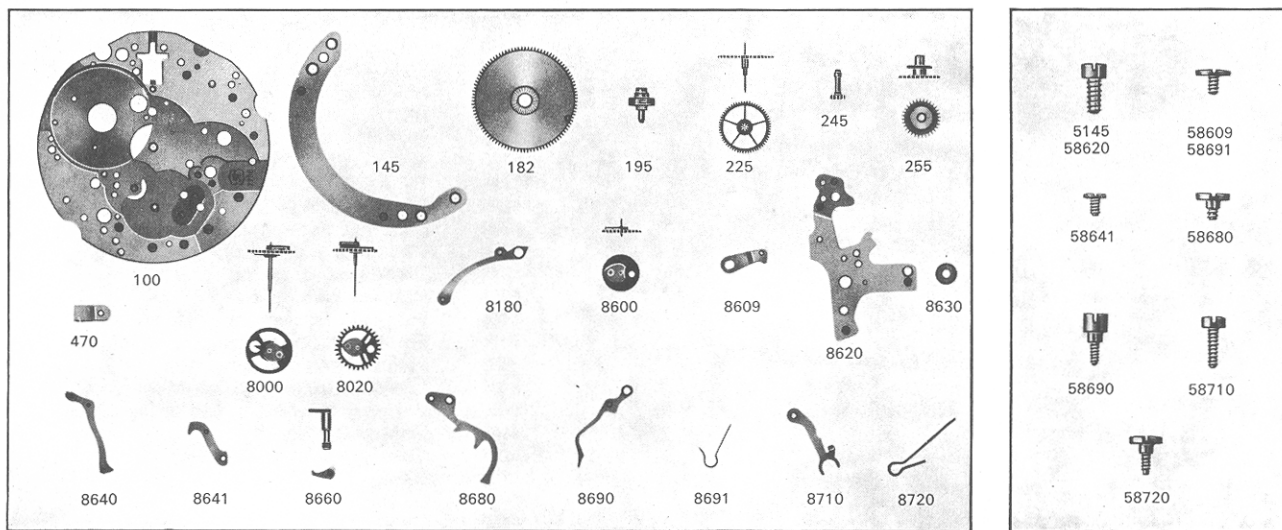

No. LIST OF MATERIALS

100	Plate	8640	Switch
145	Dial rest	8641	Switch lid
182	Barrel and cover	8660	Detent with arbor
195	Barrel arbor	8680	Hour hammer
225	Fourth wheel, two long pivots	8690	Hour recorder stop lever
245	Cannon pinion	8691	Spring for hour recorder stop lever
255	Hour wheel	8710	Friction spring for driving pinion
470	Winding pinion guard	8720	Conveyor spring
8000	Chronograph-runner, mounted, 30 m	5145	Dial rest screw
8020	Minute-recording runner, mounted, 30 m	58609	Conveyor screw
8180	Fly-back lever (zero action)	58620	Screw for hour recorder bridge
8600	Hour-recording runner, mounted	58641	Switch lid screw
8609	Conveyor	58680	Hour hammer screw
8620	Hour recorder bridge	58690	Hour recorder stop lever screw
8630	Driving pinion	58691	Screw for spring for hour recorder stop lever
		58710	Friction spring screw for driving pinion
		58720	Conveyor spring screw

Components of basic caliber No. 7733

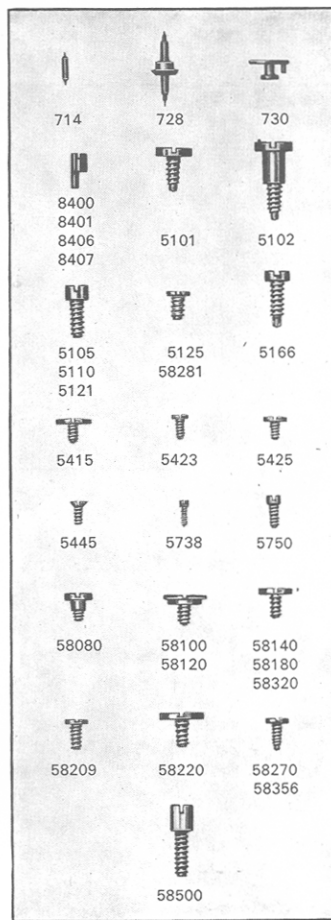
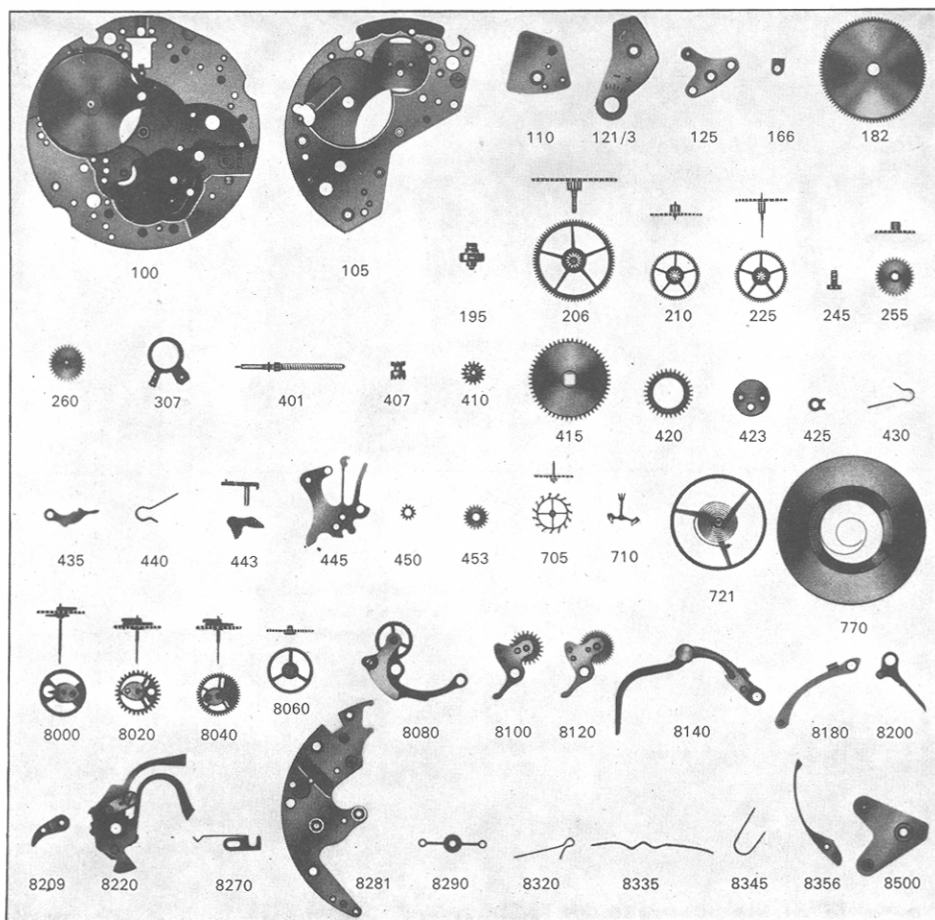

No. LIST OF MATERIALS

100	Plate	8120	Sliding gear, mounted, 45 m
105	Barrel bridge	8140	Operating lever, mounted
110	Train wheel bridge	8180	Fly-back lever
121/3	Balance cock for stud holder and for shock-protecting device, flat hairspr.	8200	Blocking lever
125	Pallet cock	8209	Blocking lever lid
166	Casing clamp	8220	Hammer mounted
182	Barrel and cover	8270	Minute-recording jumper
195	Barrel arbor	8281	Plate for chronograph mechanism
206	Center wheel	8290	Friction spring for chronograph runner
210	Third wheel	8320	Coupling clutch spring
225	Fourth wheel	8335	Operating and fly-back lever spring
245	Cannon pinion	8345	Blocking lever spring
255	Hour wheel	8356	Hammer cam jumper
260	Minute wheel	8400	Eccentric for pivoting of coupling clutch
307	Regulator with adjustable stud holder, for flat hairspring	8401	Banking eccentric for coupling clutch
401	Winding stem	8406	Finger-depth eccentric
407	Clutch wheel	8407	Eccentric for minute-recording jumper
410	Winding pinion	8500	Chronograph bridge
415	Ratchet wheel	5101	Case screw (short)
420	Crown wheel	5101	Case screw (long)
423	Crown wheel core	5102	Case screw, special
425	Click	5105	Barrel bridge screw
430	Click spring	5110	Train wheel bridge screw
435	Yoke	5121	Balance cock screw
440	Yoke spring	5125	Pallet cock screw
443	Setting lever	5166	Casing clamp screw
445	Setting lever spring	5415	Ratchet wheel screw
450	Setting wheel	5423	Screw for crown wheel core
453	Additional setting wheel	5425	Click screw
705	Escape wheel and pinion with straight pivots	5445	Screw for setting lever spring
710	Jewelled pallet fork and staff	5738	Hairspring stud screw
714	Pallet staff	5750	Dial screw
721	Balance with flat hairspring, regulated	58080	Coupling clutch screw
728	Balance staff for shock-protecting device	58100	Sliding gear screw, 30 m
730	Roller	58120	Sliding gear screw, 45 m
770	Mainspring	58140	Operating lever screw
8000	Chronograph runner, mounted, 30 m	58180	Fly-back lever screw
8000/3	Chronograph runner, mounted, 45 m	58209	Screw for blocking lever lid
8020	Minute-recording runner, mounted, 30 m	58220	Hammer screw
8040	Minute-recording runner, mounted, 45 m	58270	Minute-recording jumper screw
8060	Driving wheel	58281	Screw for plate of chronograph mechanism
8080	Coupling clutch, mounted	58320	Screw for coupling clutch spring
8100	Sliding gear, mounted, 30 m	58356	Screw for hammer cam jumper
		58500	Chronograph bridge screw

3.1.14. Lubricate (fig. 16).



Fig. 16

3.2. Assembling the hour-recorder mechanism of caliber 7736

- 3.2.1. Fit the hour-recorder stop lever and screw it tight.
- 3.2.2. Fit the switch underneath the hour-recorder bridge.
- 3.2.3. Fit the conveyor on to the detent arbor and on to the switch stud and screw it tight.
- 3.2.4. Fit the switch lid and screw it tight.
- 3.2.5. Fit the conveyor spring and screw it tight.
- 3.2.6. Fit:

the driving-pin friction spring, the winding-pin guard; then screw the whole assembly tight.

Make sure that the parts work correctly.

- 3.2.7. Fit the hammer on to its stud and tighten its screw.
- 3.2.8. Fit the cannon pinion (lubricating the center-wheel arbor) and the hour wheel.
- 3.2.9. Lubricate (fig. 17).

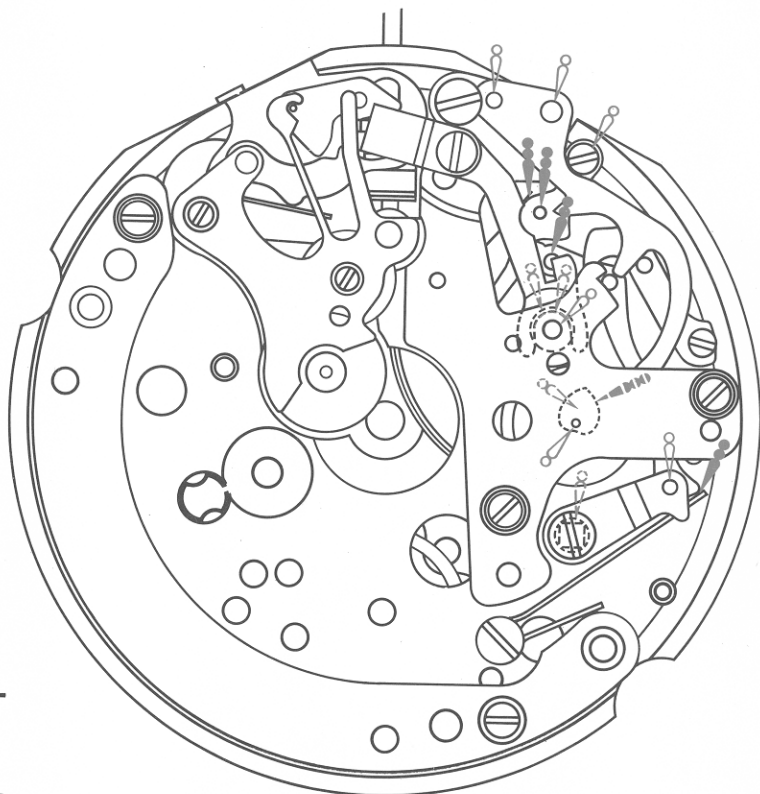

Fig. 17





3.3. Assembling the date-indicator mechanism of caliber 7734

- 3.3.1. Fit:
 - the cannon pinion (making sure to lubricate the center-wheel pivot),
 - the hour wheel,
 - the dial rest and tighten its three screws,
 - the date-indicator,
 - the date-indicator driving-wheel and screw it tight,
 - the date jumper.

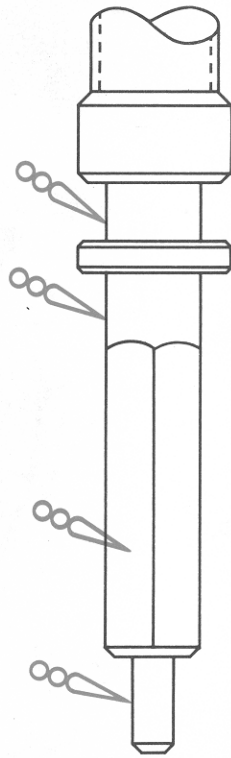
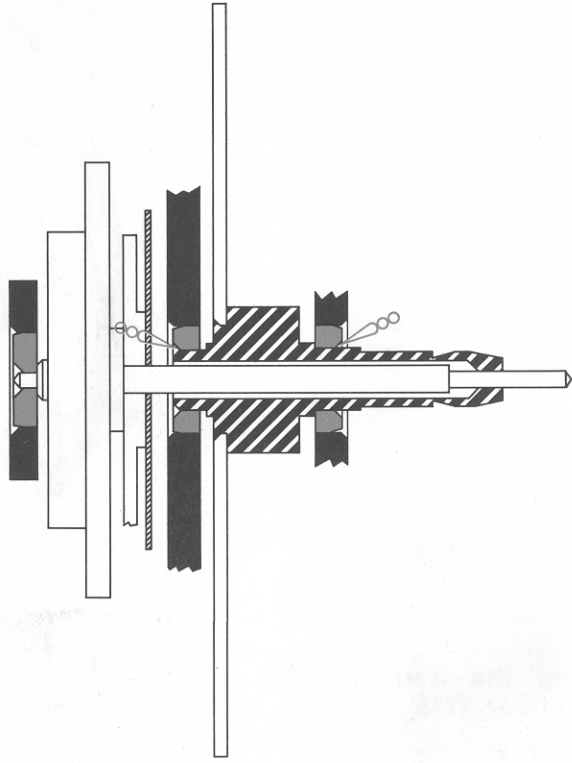
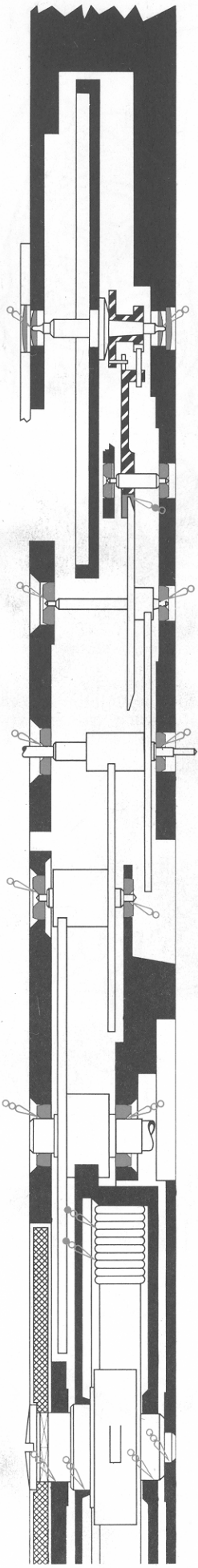
- 3.3.2. Fit the date-indicator guard and screw it tight.
- 3.3.3. Fit the date-jumper spring.
- 3.3.4. Check the working of the mechanism.

Lubrication plan



-  Fine oil
-  Thick oil or grease
-  Special grease for mainspring
-  Special oil for pallet stones
-  Special grease for mechanism