

# PARTS CATALOGUE/TECHNICAL GUIDE

## Cal. Y911A

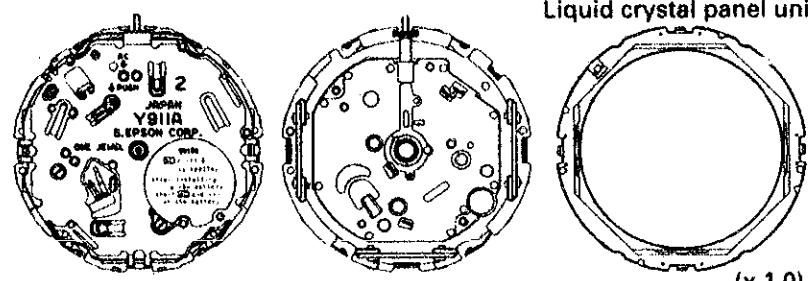

### [SPECIFICATIONS]

Item	Cal. No.	Y911A		
Movement		Liquid crystal panel unit 		
Movement size	Outside diameter	ø33.0 mm		
	Height (including the liquid crystal panel unit)	6.9 mm		
Time indication	Analogue section	Digital section		
		3 hands	High molecular, dispersion type liquid crystal display	
Driving system		Step motor (Load compensated driving pulse type)	1/2 multiplex driving system	
Display system		• Time display	• Calendar display	
Additional mechanism		• Electronic circuit reset switch • Train wheel setting device • Battery life indicator	• Alarm function (regular alarm and single-time alarm) • Hourly time signal function • Stopwatch function • Lap time/split time memory recall function	
	Loss/gain	Monthly rate at normal temperature range: less than 20 seconds		
Regulation system		Nil		
Measuring gate by quartz tester		Use 10-second gate.		
Battery		SEIKO SR927W, Maxell SR927W, Sony SR927W, EVEREADY 399 Battery life is approximately 2 years. Voltage: 1.55 V		
Jewels		1 jewel		

SEIKO CORPORATION

# PARTS CATALOGUE

Cal. Y911A

Disassembling procedures Figs. : ① → ④③  
 Reassembling procedures Figs. : ④③ ← ①  
 Lubricating: Types of oil      Oil quantity  
 Moebius A       Normal quantity

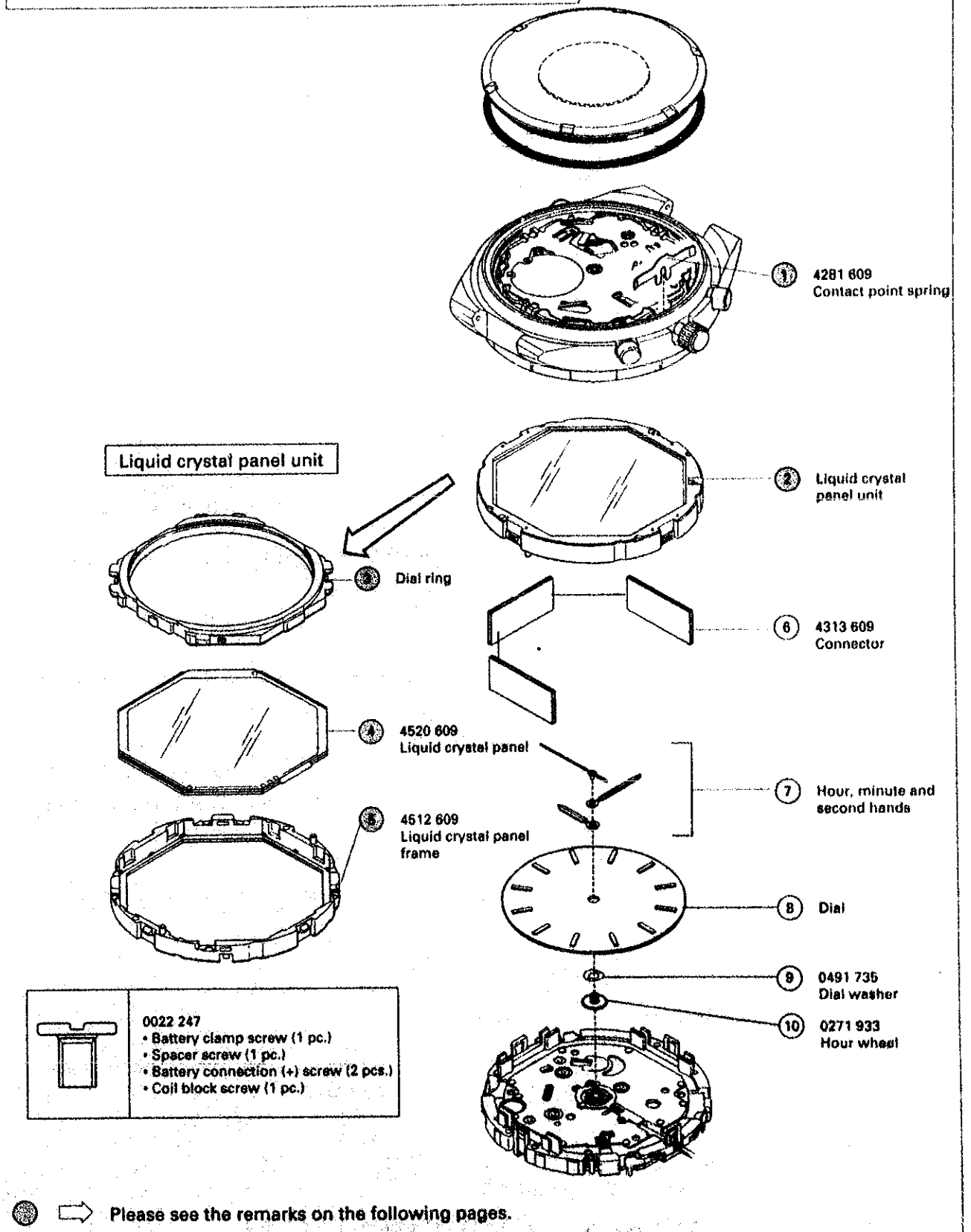

# PARTS CATALOGUE

Cal. Y911A

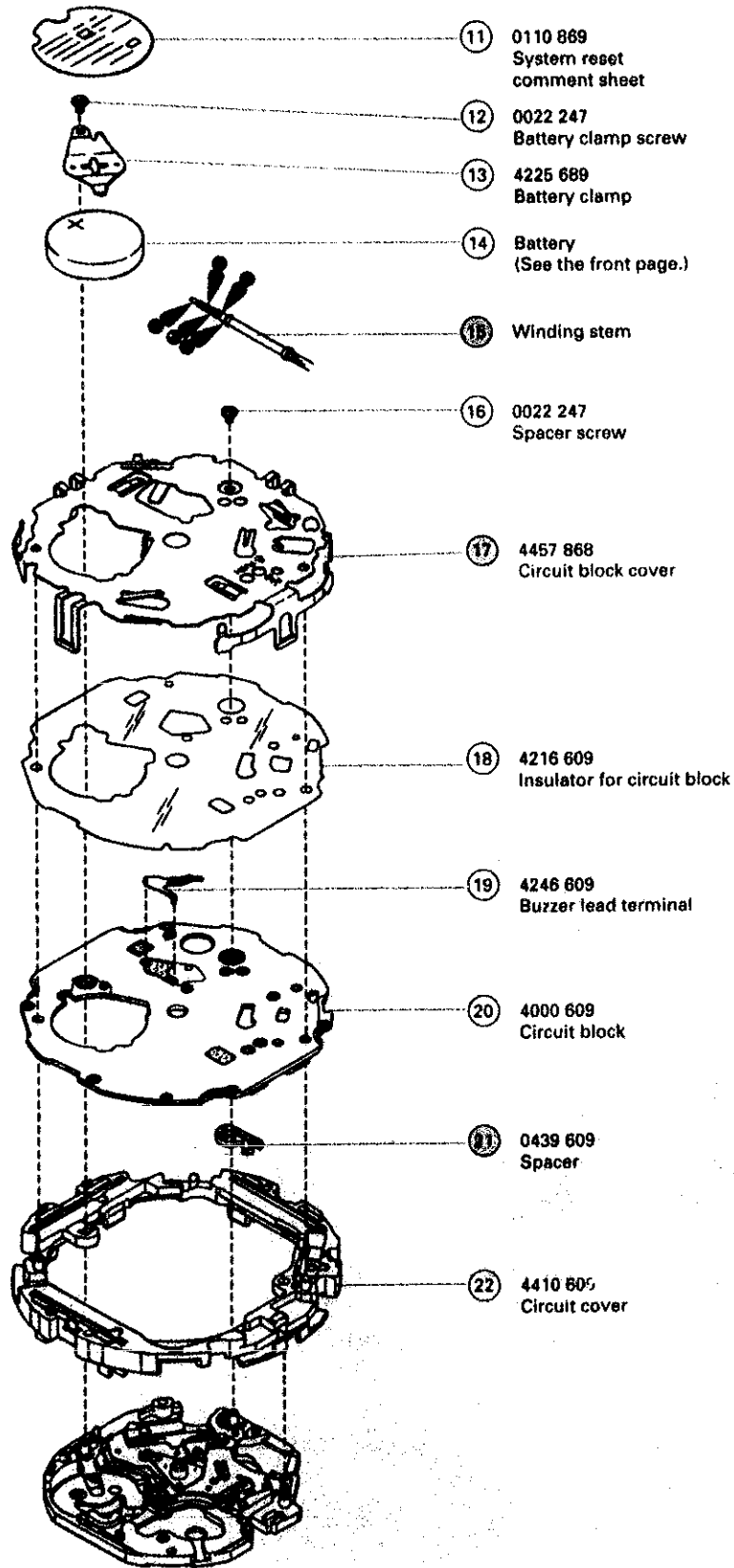

- 11 0110 869  
System reset  
comment sheet
- 12 0022 247  
Battery clamp screw
- 13 4225 689  
Battery clamp
- 14 Battery  
(See the front page.)
- 15 Winding stem
- 16 0022 247  
Spacer screw
- 17 4457 868  
Circuit block cover
- 18 4216 609  
Insulator for circuit block
- 19 4246 609  
Buzzer lead terminal
- 20 4000 609  
Circuit block
- 21 0439 609  
Spacer
- 22 4410 609  
Circuit cover

Please see the remarks on the following pages.

# PARTS CATALOGUE

Cal. Y911A

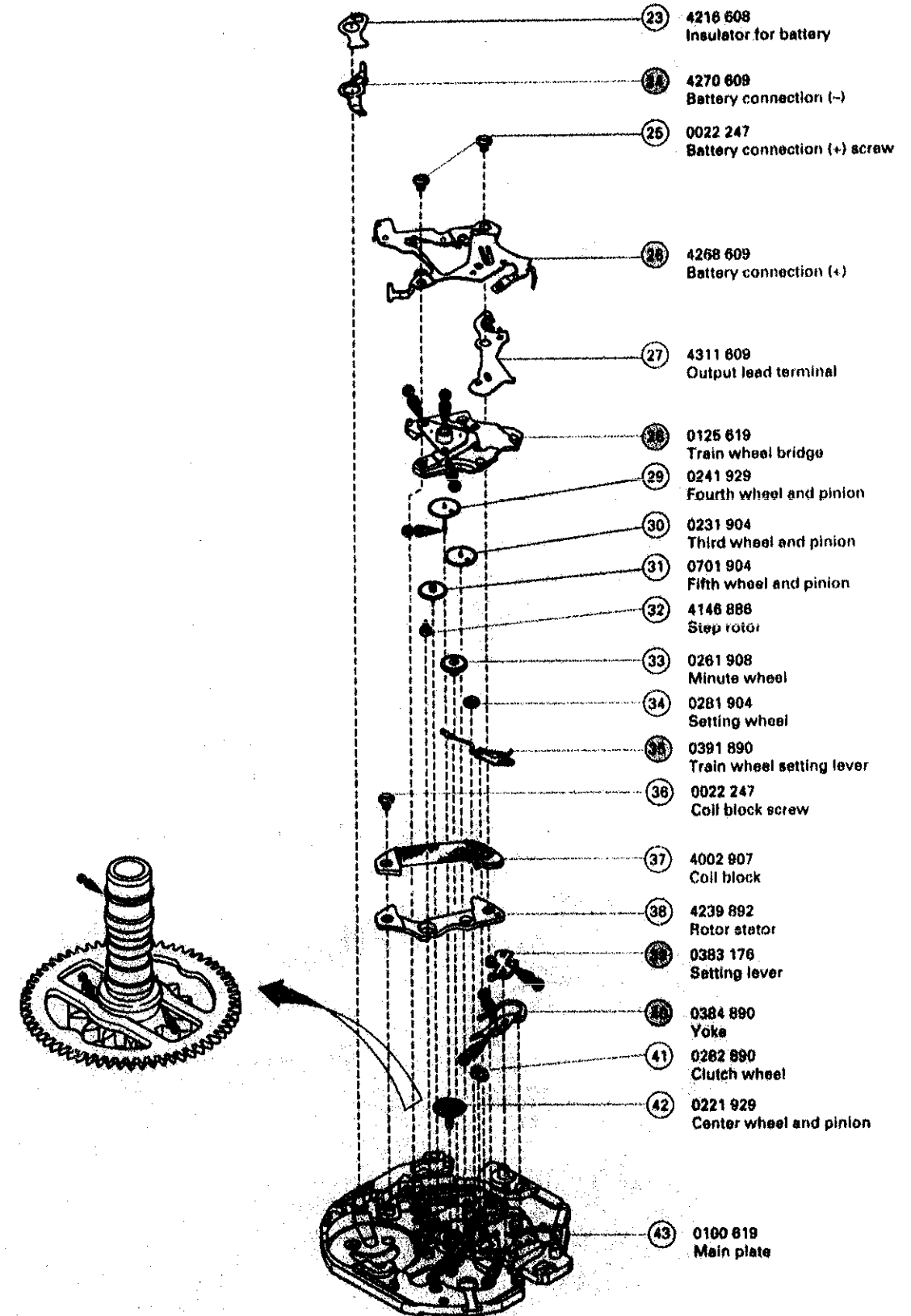

- 23 4216 608  
Insulator for battery
- 24 4270 609  
Battery connection (-)
- 25 0022 247  
Battery connection (+) screw
- 26 4268 609  
Battery connection (+)
- 27 4311 609  
Output lead terminal
- 28 0125 619  
Train wheel bridge
- 29 0241 929  
Fourth wheel and pinion
- 30 0231 904  
Third wheel and pinion
- 31 0701 904  
Fifth wheel and pinion
- 32 4146 888  
Step rotor
- 33 0261 908  
Minute wheel
- 34 0281 904  
Setting wheel
- 35 0391 890  
Train wheel setting lever
- 36 0022 247  
Coil block screw
- 37 4002 907  
Coil block
- 38 4239 892  
Rotor stator
- 39 0383 176  
Setting lever
- 40 0384 890  
Yoke
- 41 0282 890  
Clutch wheel
- 42 0221 929  
Center wheel and pinion
- 43 0100 619  
Main plate

Please see the remarks on the following pages.

**Remarks:**

⑮ Winding stem 0351 880

The type of winding stem is determined based on the design of cases. Check the case number and refer to "PULSAR Casing Parts Catalogue" to choose a corresponding winding stem.

## TECHNICAL GUIDE

- The explanation here is only for the particular points of Cal. Y911A.
- For the repairing, checking and measuring procedures, refer to the "TECHNICAL GUIDE, GENERAL INSTRUCTIONS".

### I. STRUCTURE OF CIRCUIT BLOCK

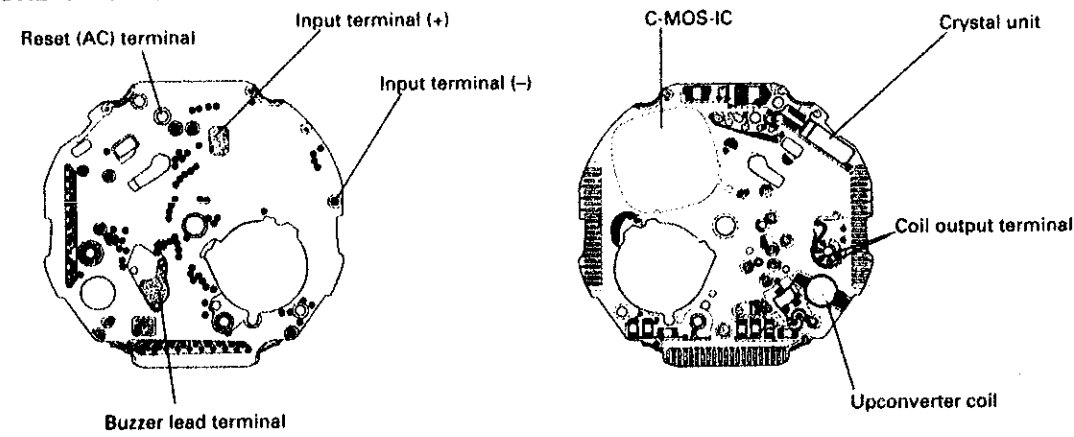

### II. REMARKS ON REMOVING AND INSTALLING THE BATTERY

- To remove the battery, first, peel off the system reset comment sheet, and then, remove the battery clamp.
- After installing the battery, be sure to attach the sheet at the position indicated in the illustration at right.

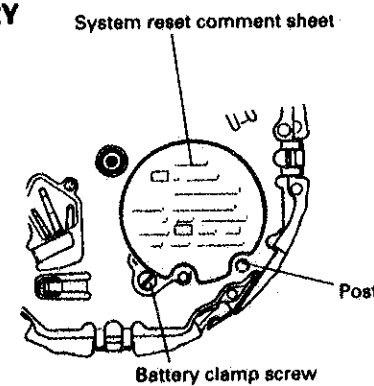

- After the battery is replaced with a new one, or after the battery is re-installed following the repairing procedures, be sure to short-circuit the AC terminal of the circuit block and the circuit block cover with conductive tweezers to reset the circuit as illustrated at right.

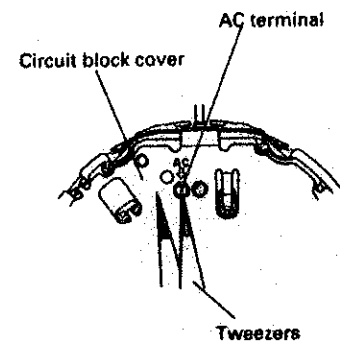

# TECHNICAL GUIDE

### III. REMARKS ON DISASSEMBLING AND REASSEMBLING

- For disassembling and reassembling of Cal. Y911A, be sure to use the movement holders for exclusive use with the movement.

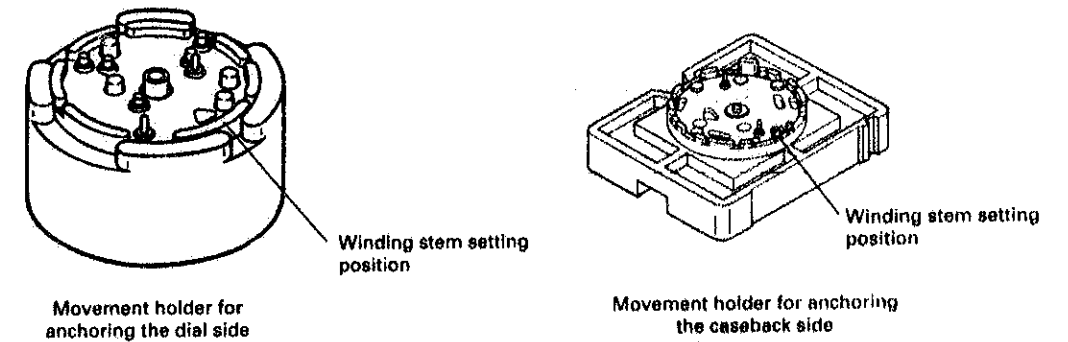

- When disassembling or reassembling, be sure to ground the movement holders.

#### ① Contact point spring

- Before removing the winding stem, be sure to remove the contact point spring. Before installing the contact point spring, be sure to install the winding stem.

#### • How to remove

- 1) Pull out the winding stem to the first click.
- 2) Hold the center of the contact point spring and lift it up as shown in the illustration at right.

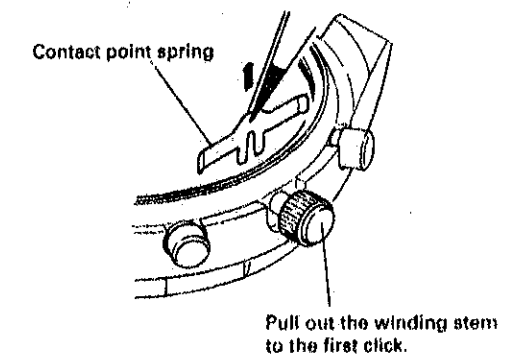

**Note:** Take care not to deform the contact point spring.

# TECHNICAL GUIDE

Cal. Y911A

## • How to install

- 1) Pull out the winding stem to the first click.
- 2) Set the slit portion ("A" portion in the illustration below) of the contact point spring to the winding stem, and then insert the contact point spring in the gap between the movement and case.

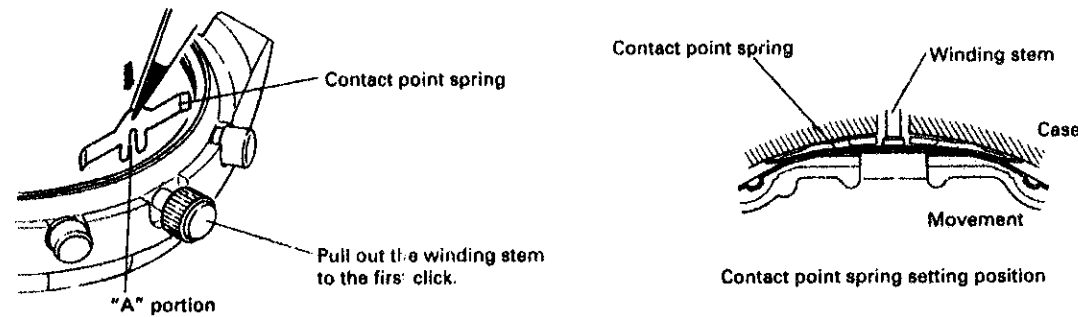

- 3) Push down the contact point spring at the center until it is set properly.

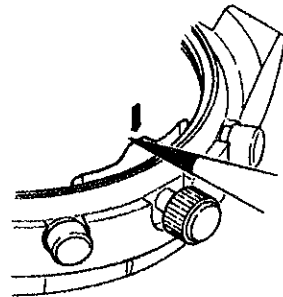

- 4) Push the winding stem back in to the normal position.

## ② Liquid crystal panel unit

## • How to remove

Release all four hooks of the liquid crystal panel from the movement, and then lift up the liquid crystal panel unit.

## • How to install

- 1) Set the three connectors to the connector guide portions of the liquid crystal panel unit, and then, set the panel unit level to the movement.

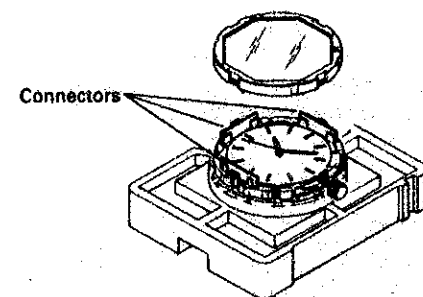

# TECHNICAL GUIDE

Cal. Y911A

- 2) Press the liquid crystal panel unit evenly with a flat plate or the like so that all the hooks at the 12 o'clock, 3 o'clock, 6 o'clock and 9 o'clock sides catch the movement at the same time.

**Note:** Check that all the four hooks securely catch the movement.

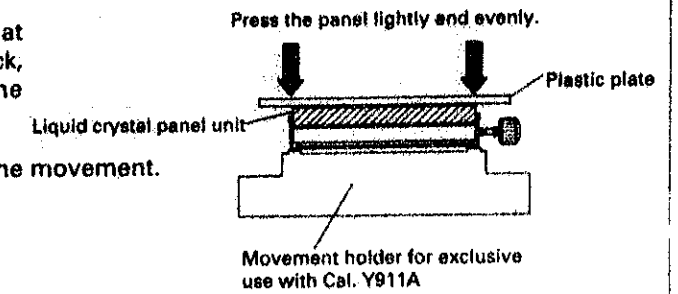

- 3) After installing the liquid crystal panel unit, check that all the segments of the display light up. (To light up all the segments of the display, refer to "All the segments lit up".)

**Note:** If any of the segments do not light up, remove the liquid crystal panel unit and re-install it.

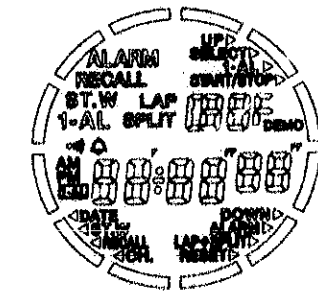

All the segments lit up

- ③ Dial ring
- ④ Liquid crystal panel
- ⑤ Liquid crystal panel frame

First, reassemble the dial ring, liquid crystal panel and liquid crystal panel frame into a unit, and then, set the unit to the movement.

## • To reassemble the parts into the liquid crystal panel unit

- 1) Place the liquid crystal panel frame so that the panel backlash correction spring portion is positioned at upper right as shown in the illustration at right.

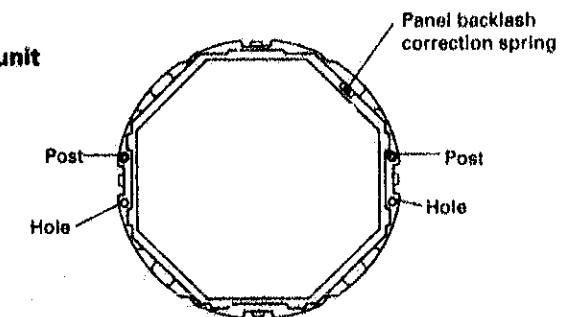

- 2) Set the liquid crystal panel to the liquid crystal panel frame so that the three fish eyes and the center of the three electrodes are positioned at the upper right and at the bottom, respectively.

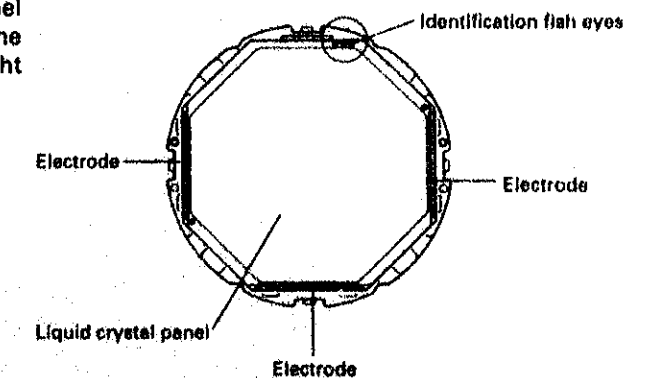

# TECHNICAL GUIDE

Cal. Y911A

3) Set the dial ring to the liquid crystal panel frame so that its thickest rim and the corner having one protrusion are positioned atop and at the upper right, respectively.

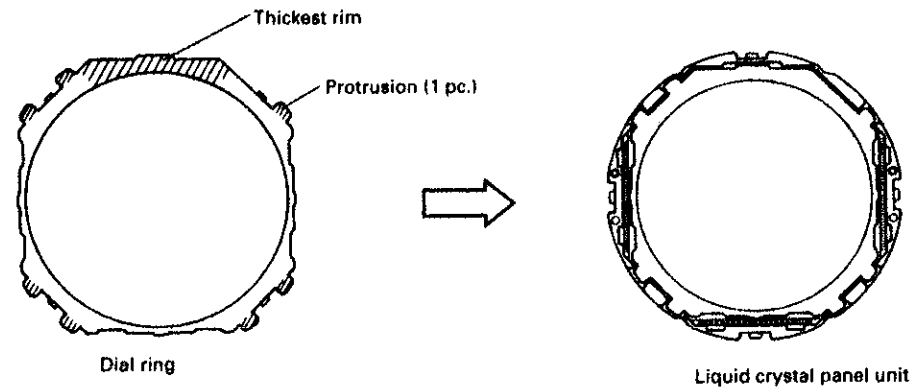

### • Precautions on the liquid crystal panel

- Be sure to ground the movement holder.
- Use finger cots to hold the liquid crystal panel. Do not hold it too tightly with tweezers, etc. The liquid crystal panel is rather vulnerable to external pressure which could cause the liquid crystal to leak.
- Hold the liquid crystal panel at the side faces, taking care not to touch the electrodes.
- If dust collects on the liquid crystal panel, apply a rodico gently to the dust to wipe it off.
- If the liquid crystal panel is soiled, wipe it gently with a soft cloth soaked with alcohol.



### 17 Circuit block cover

#### • How to install

Have the three hooks of the circuit block cover catch the main plate securely as shown in the illustration at right.

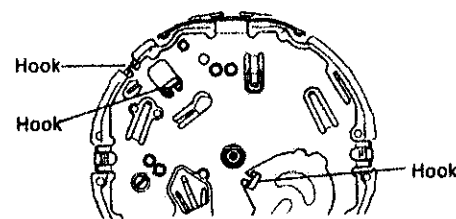

### 21 Spacer

#### • How to install

Set the spacer as shown in the illustration at right.

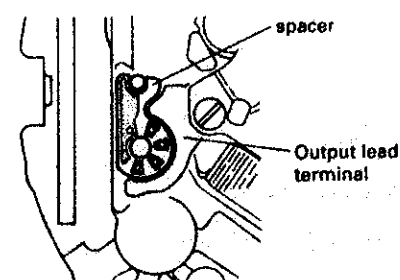

# TECHNICAL GUIDE

Cal. Y911A

### 24 Battery connection (-)

#### • How to install

Set the battery connection (-) to the main plate so that there is no gap between them ("A" and "B" portions in the illustration at right).

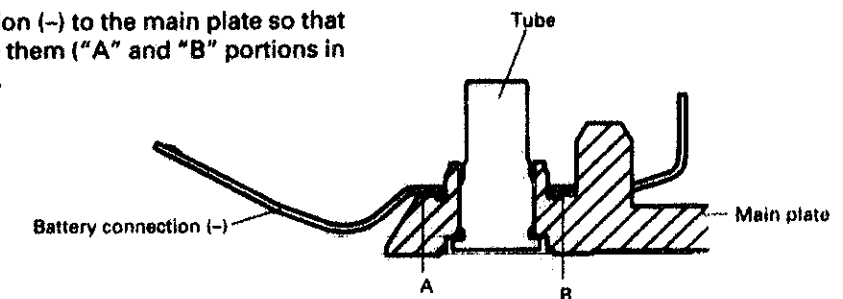

### 26 Battery connection (+)

#### • How to install

Have the two hooks of the battery connection (+) catch the main plate securely.

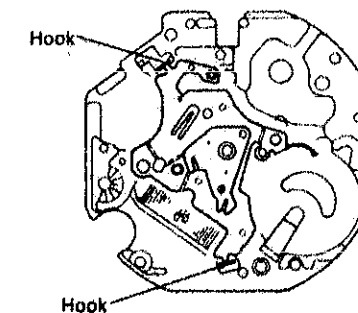

### 28 Train wheel bridge

#### • Setting position

Refer to the illustrations below to check where to install the respective wheels.

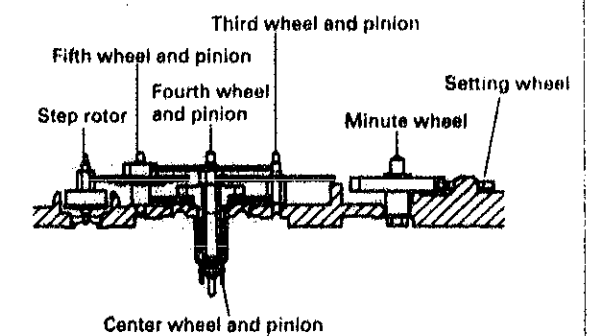
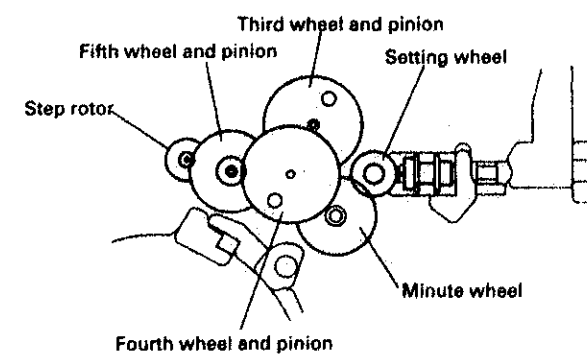

### 35 Train wheel setting lever

### 39 Setting lever

### 40 Yoke

#### • Setting position

Refer to the illustration at right.

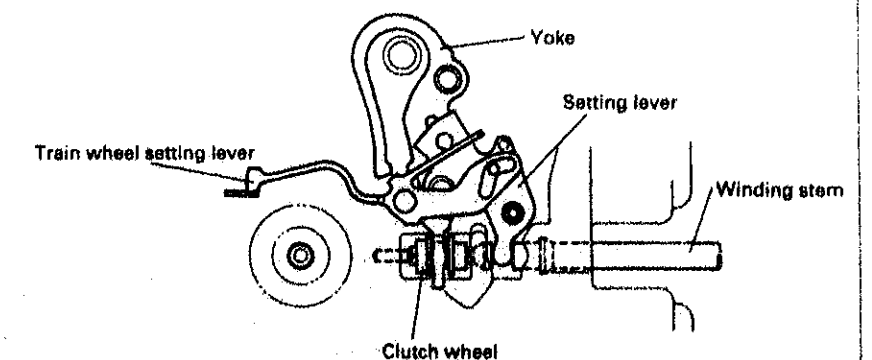

# TECHNICAL GUIDE

Cal. Y911A

## IV. VALUE CHECKING

### • Coil block resistance

1.8 K $\Omega$  ~ 2.2 K $\Omega$

### • Upconverter coil resistance

120  $\Omega$  ~ 180  $\Omega$

### • Current consumption

For the whole movement in the "Blank" display: Less than 1.3  $\mu$ A  
 For the whole movement in any digital display with the stopwatch reset: Less than 33.0  $\mu$ A  
 For the circuit block alone: Less than 0.7  $\mu$ A

#### Remarks:

Measure the current consumption at 24°C  $\pm$  2°C.  
 The current consumption for the liquid crystal panel used in this calibre fluctuates depending on the ambient temperature. If the current consumption of the whole movement in any display with the stopwatch reset cannot be measured within the above temperature range, refer to the table below to check if the obtained current consumption is normal.

Ambient temperature	20°C	24°C	30°C
Allowable current consumption	Less than 32 $\mu$ A	Less than 33 $\mu$ A	Less than 36 $\mu$ A

#### <Measuring the current consumption for the whole movement>

- 1) After connecting the tester, pull out the crown to the first click and push it back in to the normal position.
- 2) Check that the digital display can be turned on and off, and then start the measurement.  
 To turn off the digital display, change the display to the CALENDAR and leave the watch untouched. The display will be turned off automatically in about 10 seconds.

#### <Measuring the current consumption for the circuit block alone>

- 1) After connecting the tester as shown in the illustration below, short-circuit the reset pattern and (+) pattern.
- 2) Start the measurement more than 10 seconds after short-circuiting the patterns.

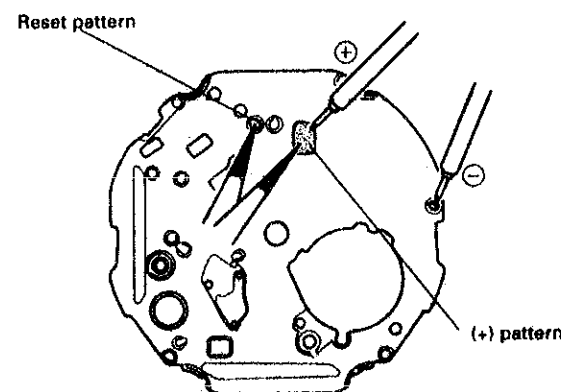

# TECHNICAL GUIDE

Cal. Y911A

### • All the segments lit up

Follow the procedure below to check that all the segments of the display will light up.

- 1) Press button "A" in the "Blank" display.
- 2) Press button "C".
- 3) Press button "B".
- 4) Press buttons "B" and "C" at the same time.

- To return to the normal display, press button "A", "B" or "C".

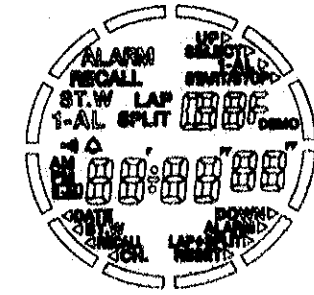

All the segments lit up

### • Checking the functions

For the crown and button functions in each display, refer to the table below.

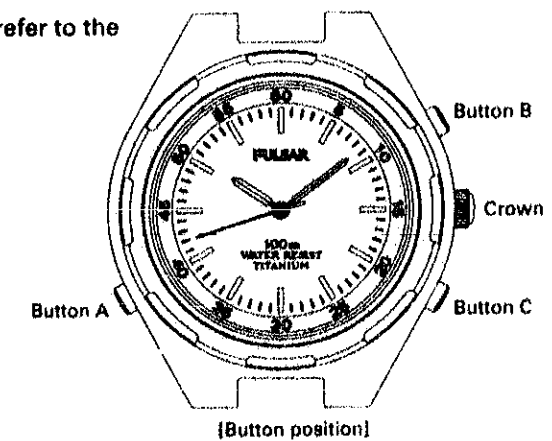

Display	Crown	Button A	Button B	Button C
In normal display (In "Blank" display)	• Time setting at first click	• Calendar display • Changeover of display	• Calendar display	• Calendar display
In CALENDAR display	• Time setting at first click	• Changeover of display	• Selection of single-time alarm	• Selection of regular alarm
In SINGLE-TIME ALARM display	• Time setting at first click	• Changeover of display	• Increasing the digits to be adjusted	• Decreasing the digits to be adjusted
In REGULAR ALARM display	• Time setting at first click	• Selection of regular alarm	• Regular alarm setting	• Alarm sound test
In REGULAR ALARM SETTING display	• Time setting at first click	• Changeover of display	• Selection of the digits to be adjusted	• Setting the digits
In STOPWATCH display	• Time setting at first click	• Changeover of display	• Start/stop	• Lap/split/reset • Changeover between lap time and split time displays
In MEMORY RECALL display	• Time setting at first click	• Changeover of display	• Recall of stored data of lap/split	• Selection of desired type of data
In TIME SETTING display	• Setting the hands by turning at first click  • Starting both digital and analogue times by pushing back in to normal position	-----  -----	• Selection of the digits to be adjusted  -----	• Setting the digits  -----

# TECHNICAL GUIDE

Cal. Y911A

- \* In each display, guide marks are displayed to indicate button operations. Check them before operating buttons.
- \* If the watch is left untouched in the display other than the TIME SETTING display for the times specified below, the display will automatically return to the "Blank" display.
  - In the CALENDAR and ALARM displays: 10 seconds
  - In the STOPWATCH display: 10 minutes
  - In the MEMORY RECALL display: 1 to 2 minutes
- \* When changing over the display to another, check if an abnormal display appears.

**Note:** If any malfunction is found after checking the functions, follow the procedure below to reset the circuit. Then, check the functions again.  
Circuit resetting procedure: Pull out the crown to the first click, and then, press all the buttons at the same time for 2 to 3 seconds.